

A	1x	1812x335
B	1x	1812x335
C	1x	1780x330
D	1x	1780x330
D1,C1	2x	1780x311
G1	4x	1796x351
G2	1x	1796x384
I,J	2x	1774x339
H	6x	687x291
H1	2x	687x291
H2	4x	368x305

Z1	16x	
Z2	1x	
Z2	8x	
Z10	2x	
Z10	2x	
Z16	16x	
Z29	16x	
Z30	16x	
Z33	12x	
Z40	26x	
Z58	4x	
Z63	2x	
Z78	40x	
Z81	2x	
Z90	8x	
Z96	2x	
Z156	48x	
Z140	2x	
Z167	26x	
Z190	6x	

Z106	2x	
------	----	--

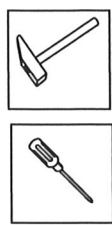
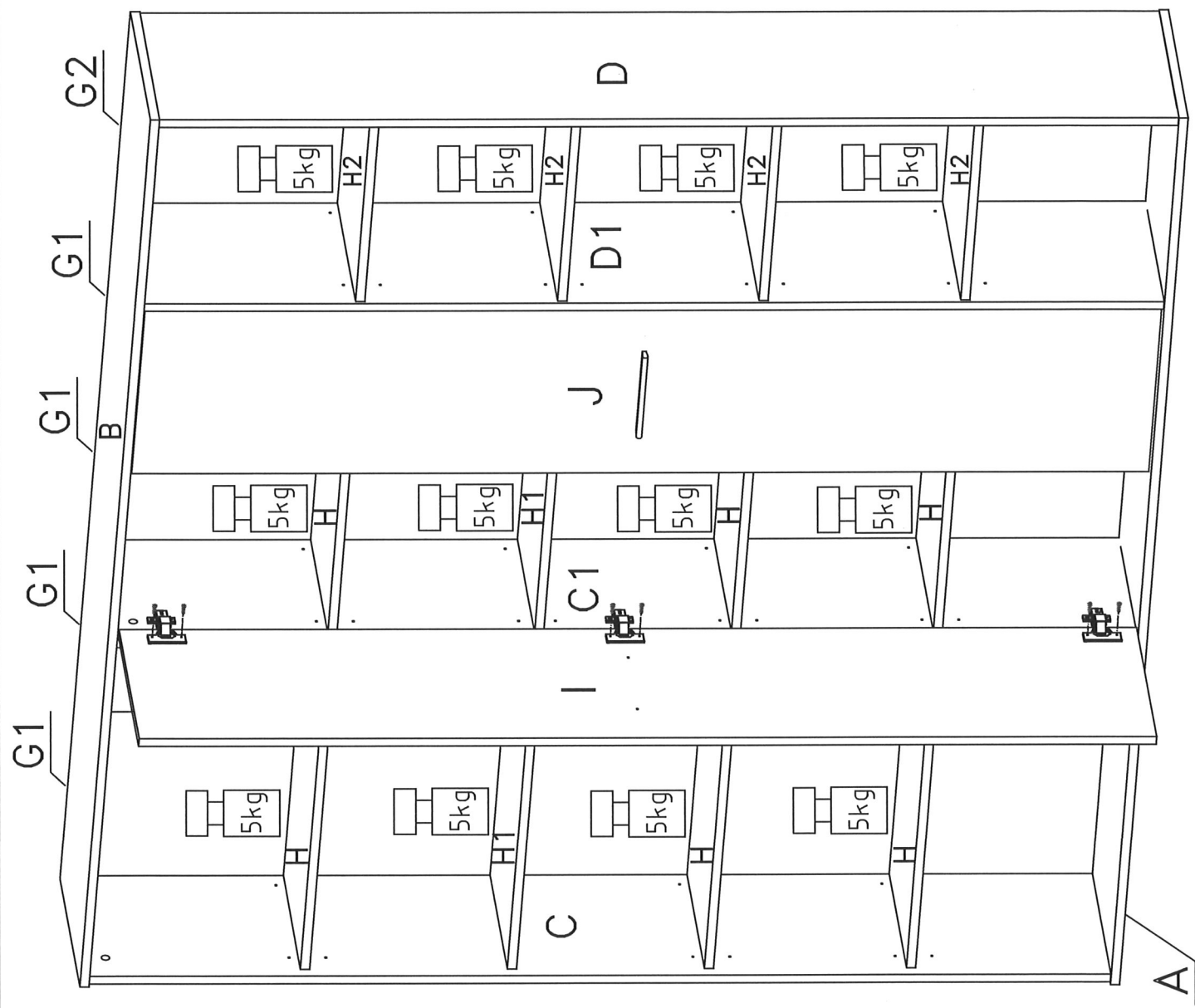

MA50

A

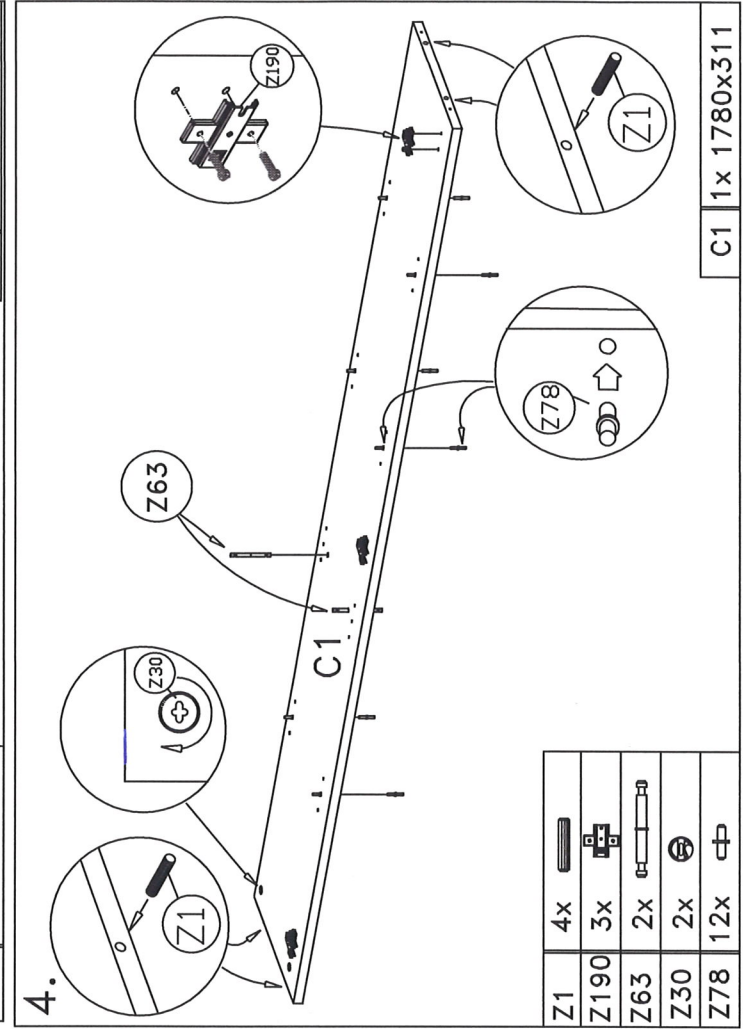
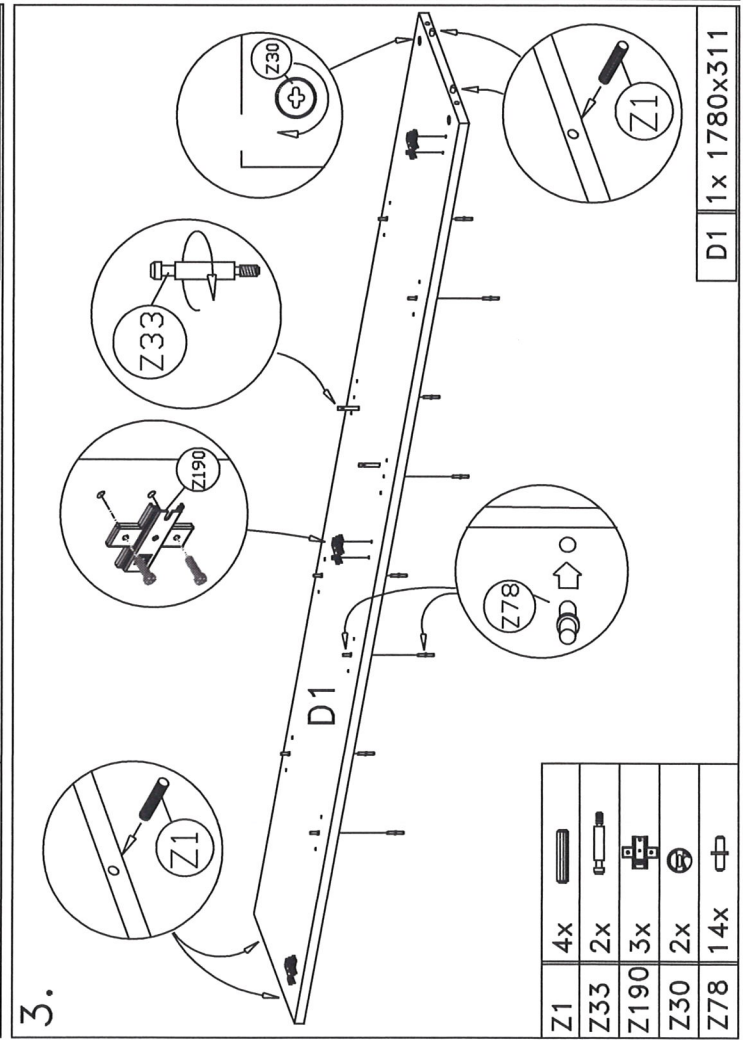
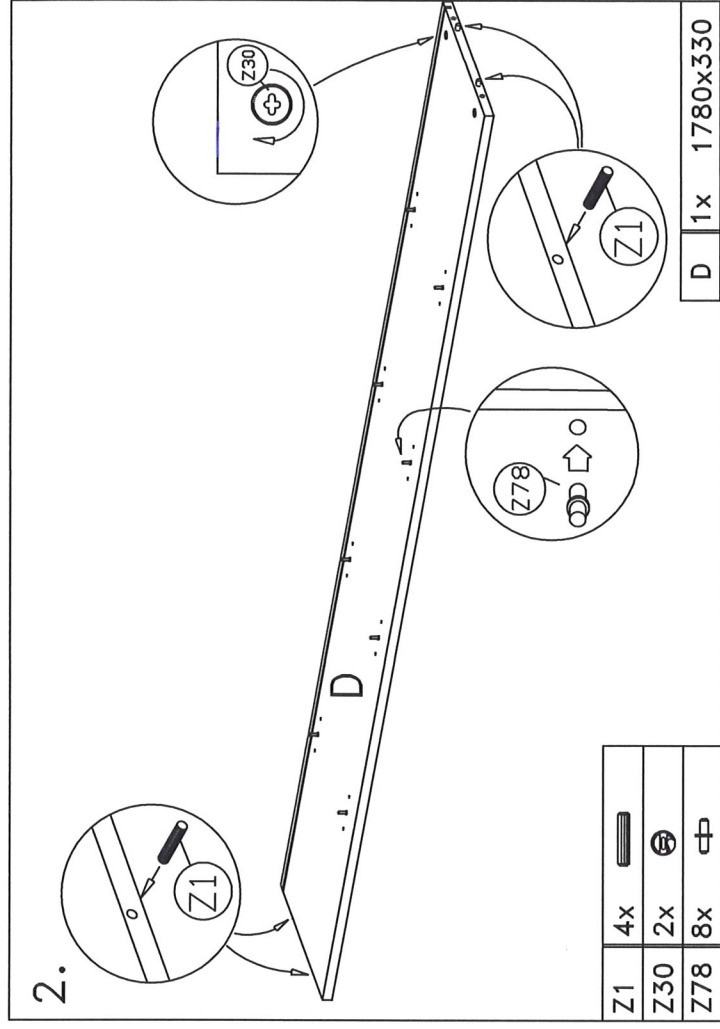
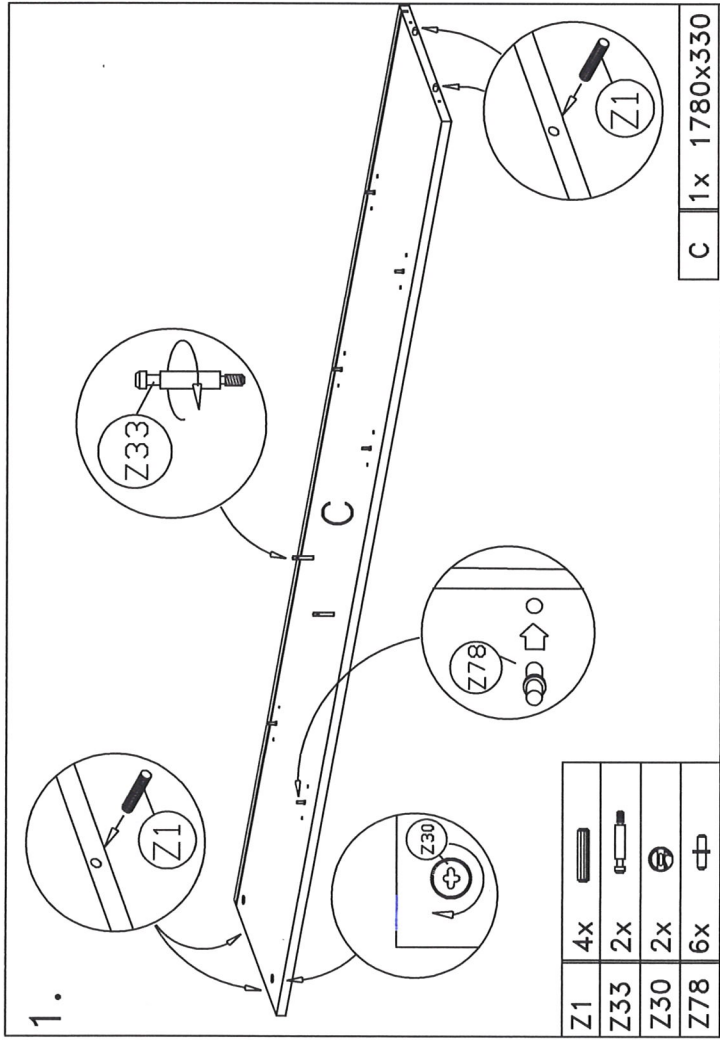

5.

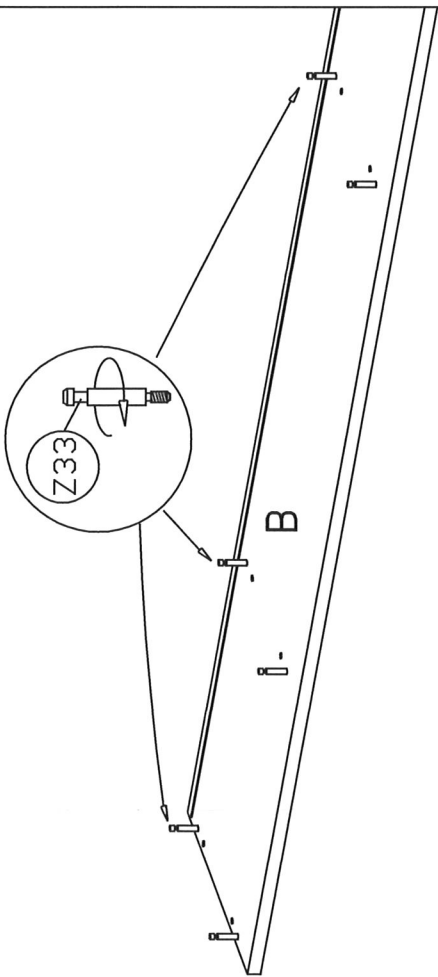

Z33 8x



A 1x 1812x335

6.

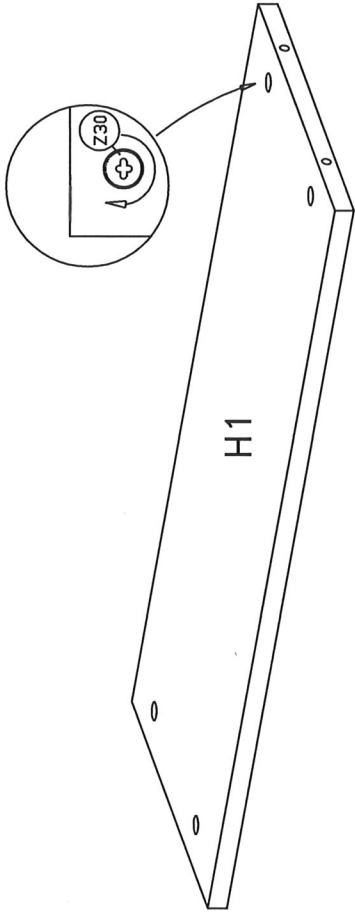

Z30 4x



H1 2x 687x291

7.

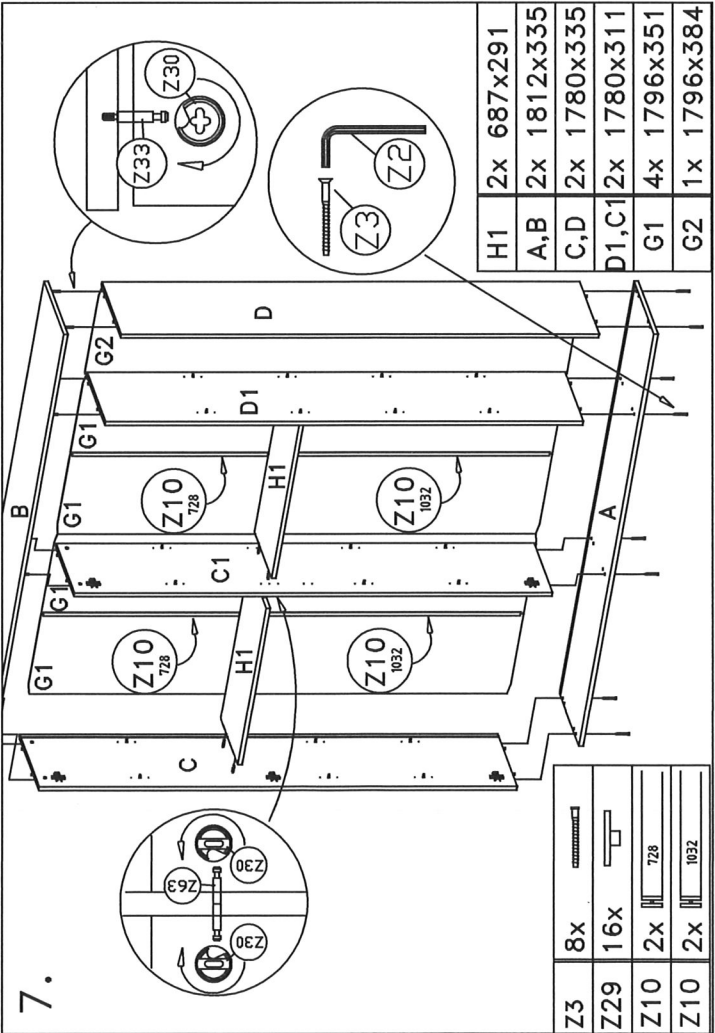

Z3	8x	
Z29	16x	
Z10	2x	
Z10	2x	

H1	2x 687x291
A,B	2x 1812x335
C,D	2x 1780x335
D1,C1	2x 1780x311
G1	4x 1796x351
G2	1x 1796x384

8.

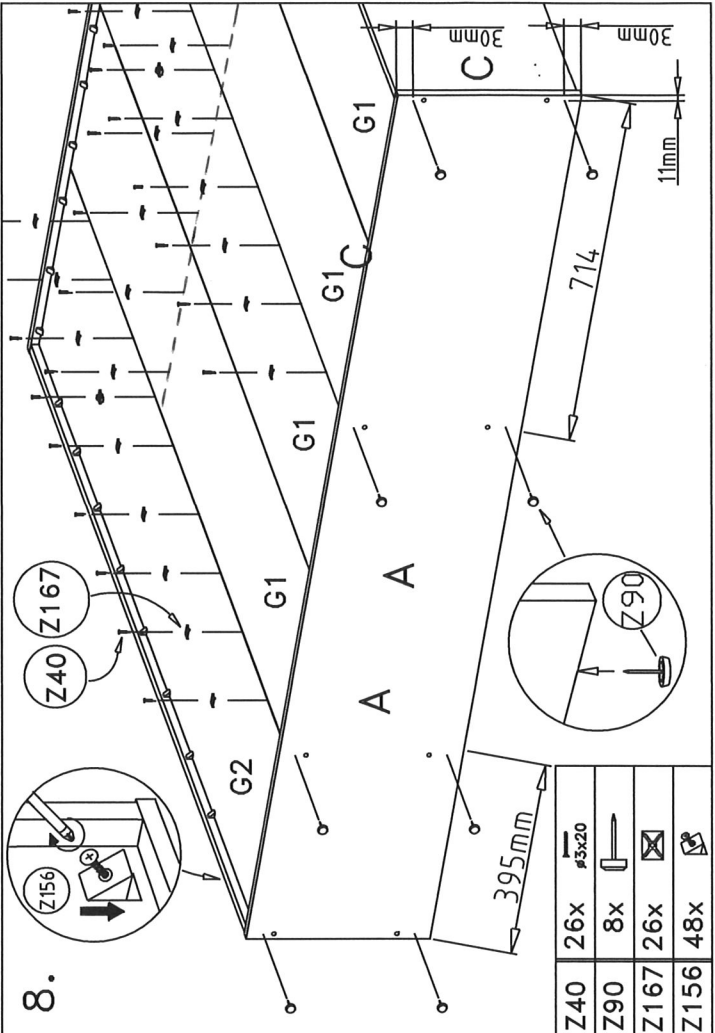

Z40	26x	
Z90	8x	
Z167	26x	
Z156	48x	

Z30 4x



H1 2x 687x291

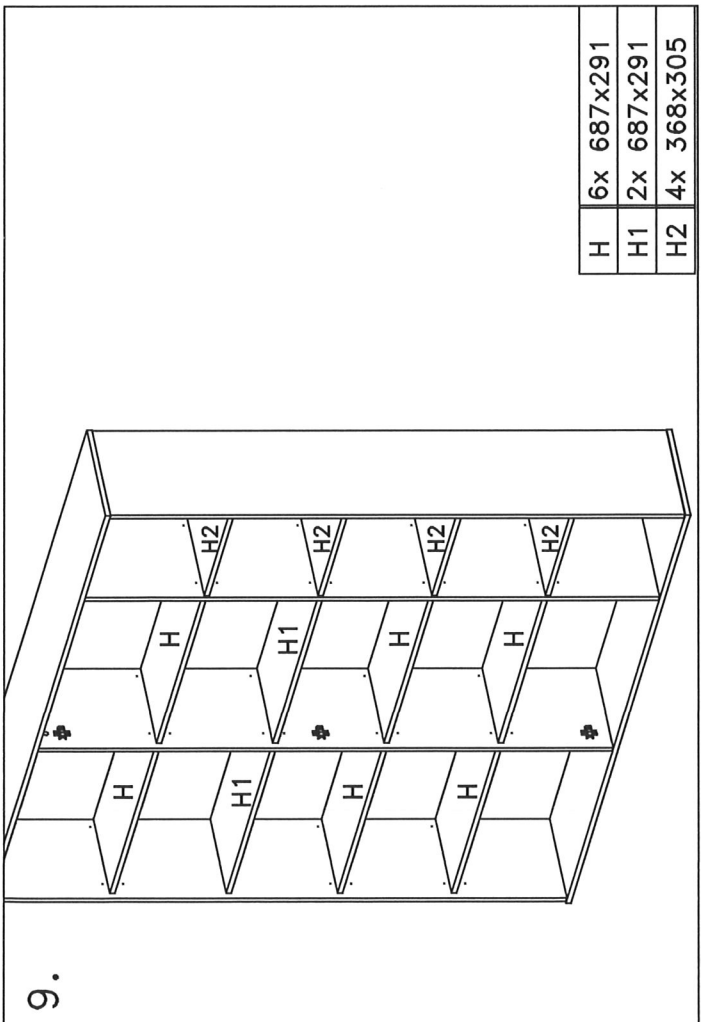

H	6x	687x291
H1	2x	687x291
H2	4x	368x305

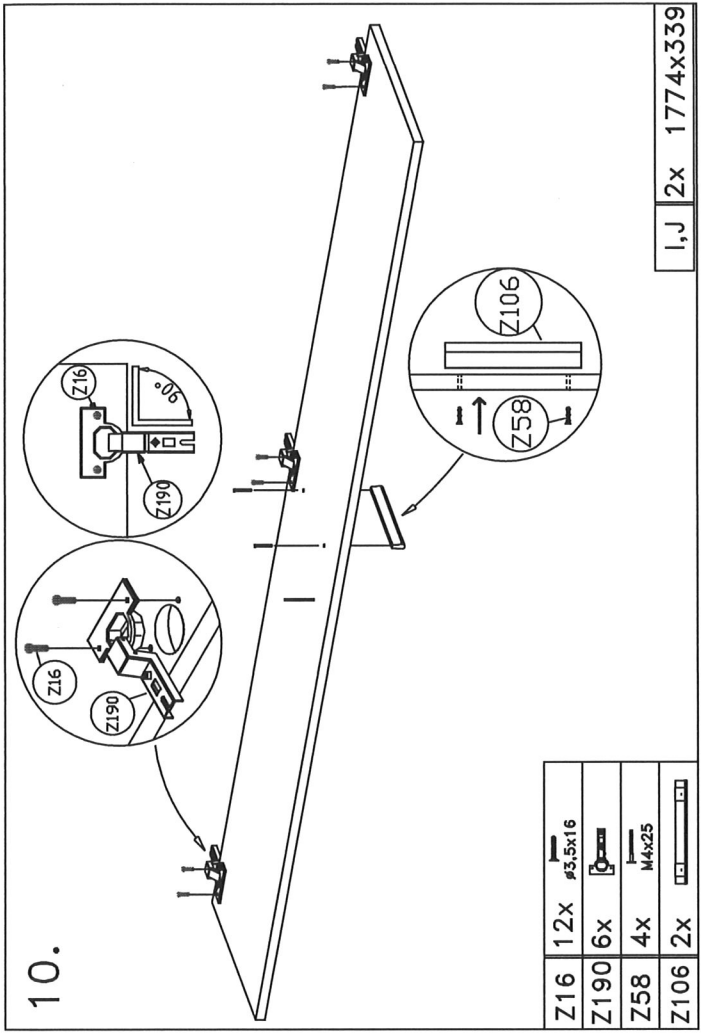

Z16	12x	#3.5x16
Z190	6x	
Z58	4x	M4x25
Z106	2x	

I, J	2x	1774x339
------	----	----------

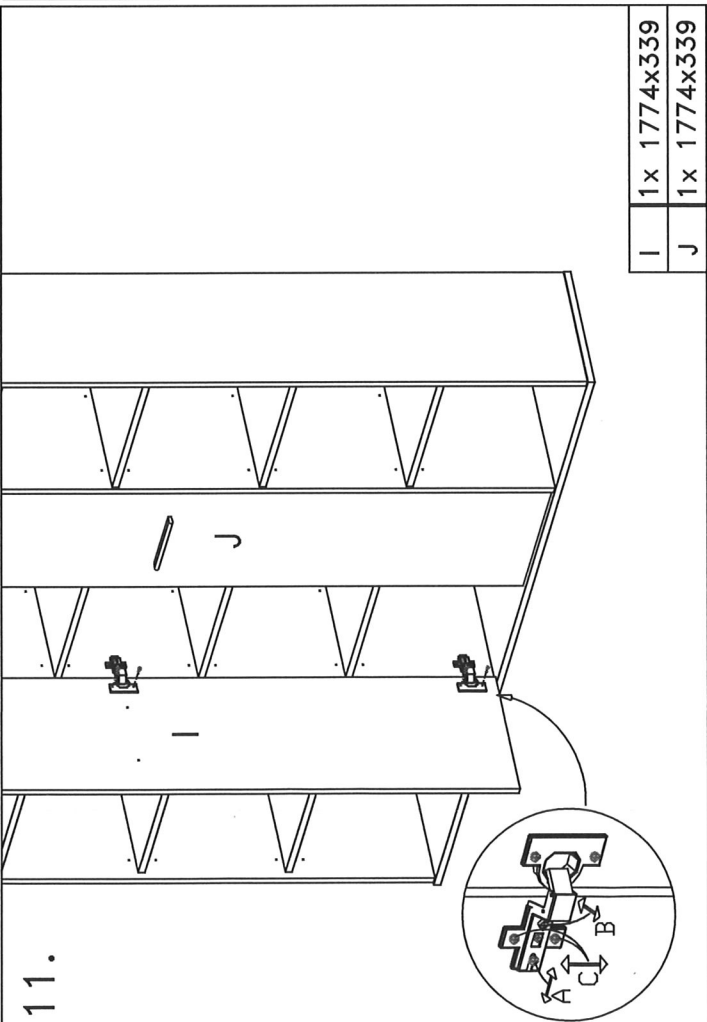

I	1x	1774x339
J	1x	1774x339

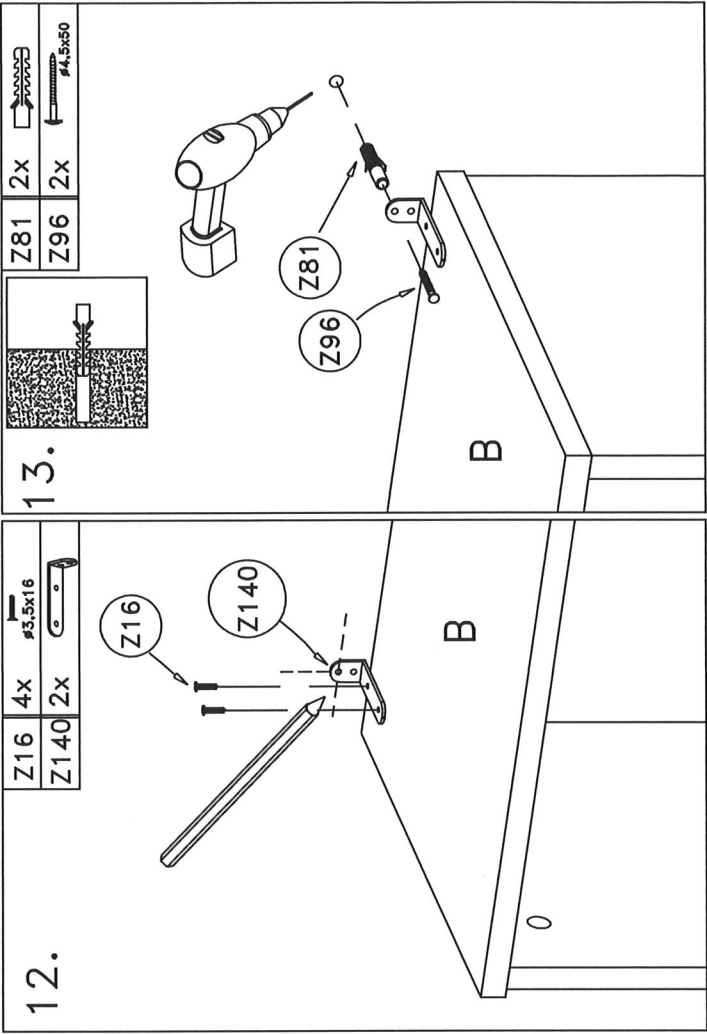

Z16	4x	#3.5x16
Z140	2x	

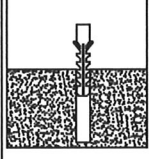

Z81	2x	
Z96	2x	#4.5x60

