

# ADELI TYP 2

Art.-Nr.

298 482  
298 481

600  
692  
300  
mm

1/6  
VO

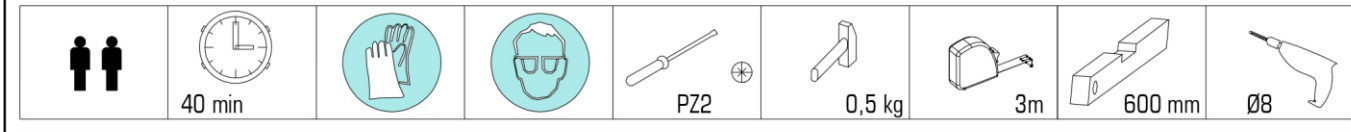

ID EE	ID	Part	Qty	Ratio
17949	②	600*300*16	2x	1/1
17950	③	644*280*16	2x	1/1
17954	④	478*296*16	2x	1/1
17952	⑤	279*566*16	1x	1/1
17953	⑥	670*296*3	2x	1/1
17955	⑦	594*157*16	1x	1/1
17956	⑧	250*100*16	1x	1/1
17969	⑨	250*100*16	1x	1/1
17957	⑩	510*100*16	1x	1/1
17958	⑪	540*256*3	1x	1/1

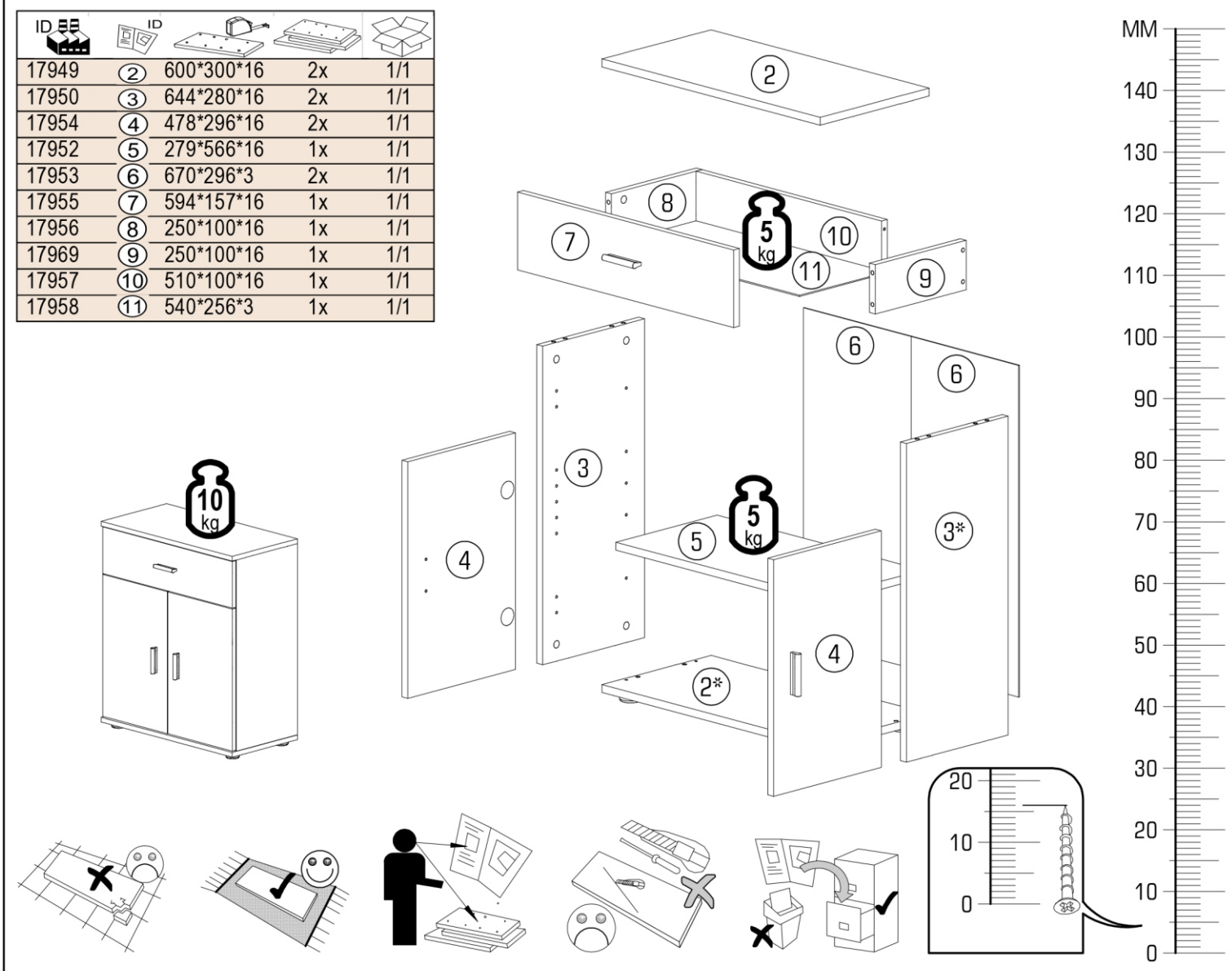

27000.00	Ø8x30	22243.00	Ø3,5x15	22250.00	Ø4x25	22244.01	Ø3,5x16	35101.01		21102.00	Ø1,6x20	22213.00	Ø4x70	24103.00	Ø8	70013.01	Ø15x13
A	8x	B	14x	C	4x	D	6x	E	4x	F	25x	G	1x	H	1x	J	12x
70021.01				31103.00		36002.07		36002.07		22430.00	Ø4x25	30080.00	Ø44x15	32314.01	L=84	22300.00	Ø7x50
K	12x	L	12x	M	1x	N	4x	P	4x	R	6x	S	4x	T	3x	U	4x
22705.00	Ø6,3x8	22800.01		33005.01	L=250	33005.01	L=250										
V	4x	W	1x	Z1	1x	Z2	1x										

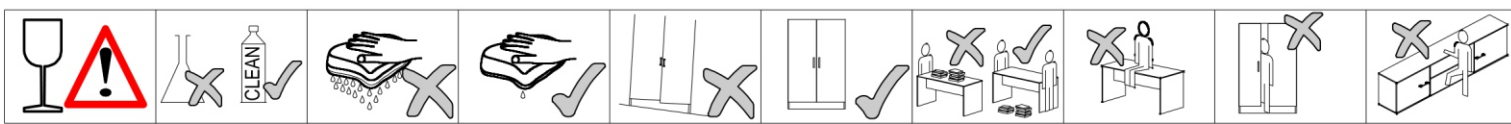

B	8x	K	8x	N	4x	R	8x	T	4x	K	8x	T	4x

A	8x	B	2x	E	4x	J	18x	P	4x	V	4x	Z1	1x

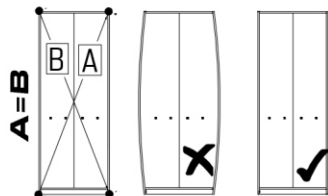
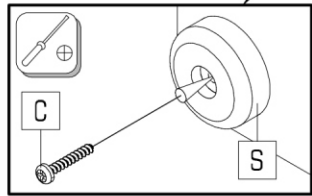
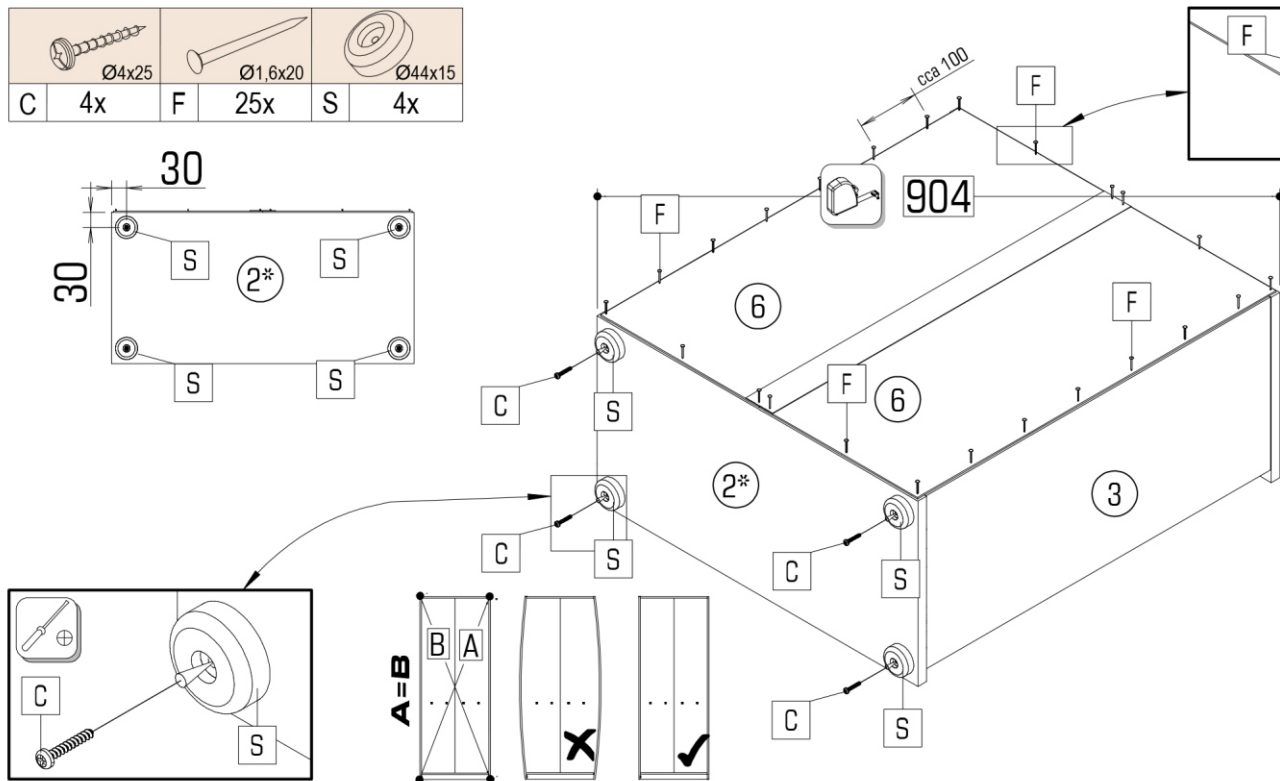
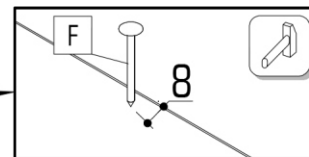
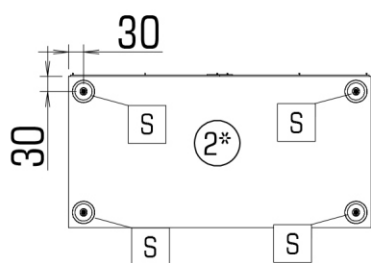
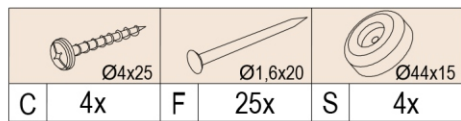
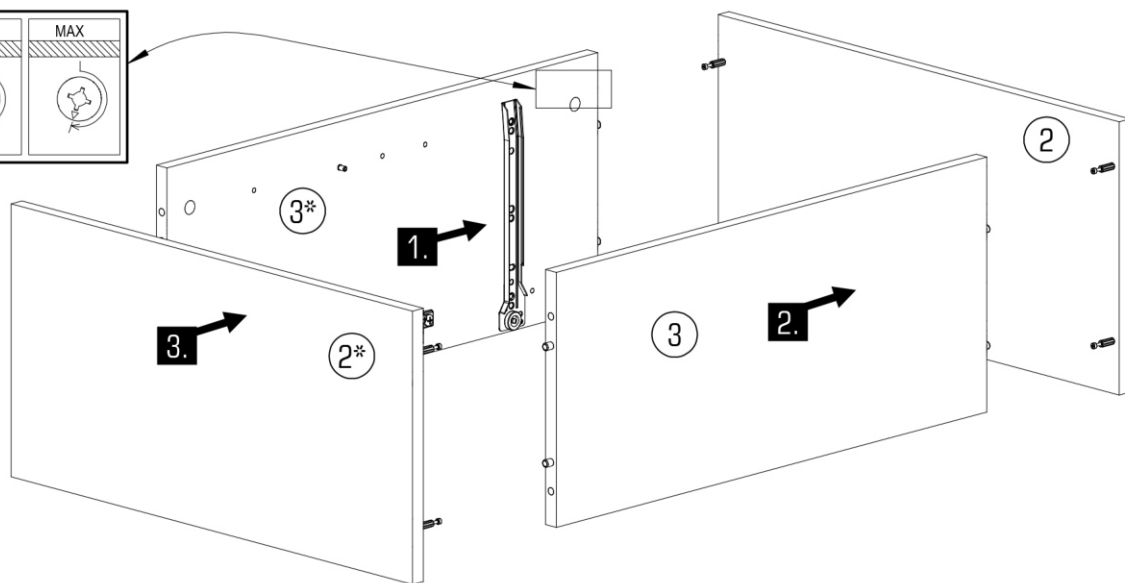
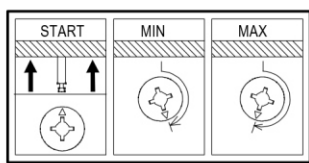
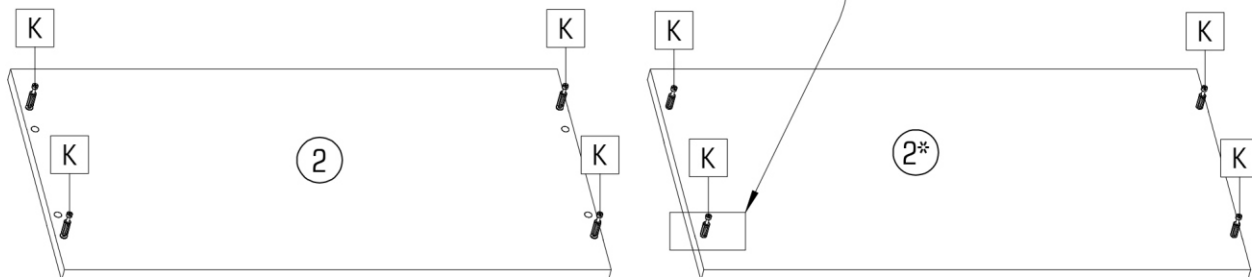
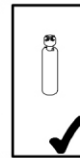
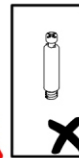
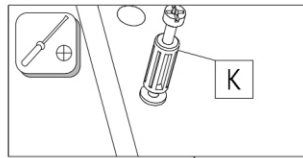
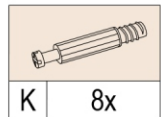

D	2x	G	1x	H	1x	L	8x	M	1x

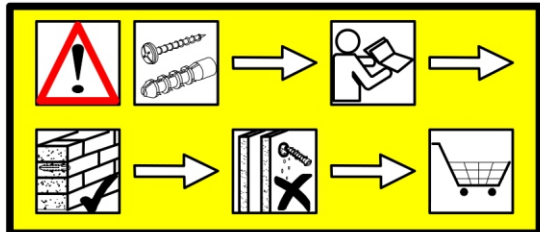
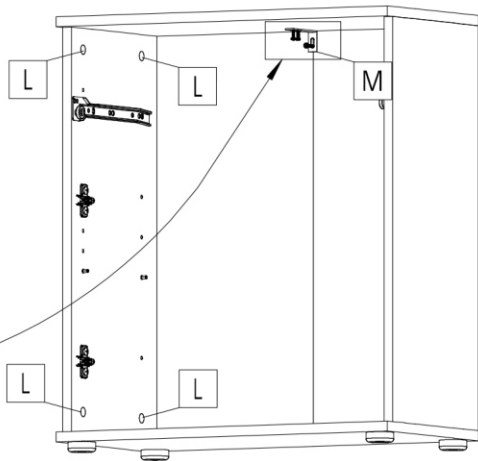
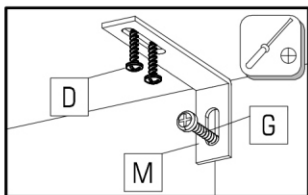
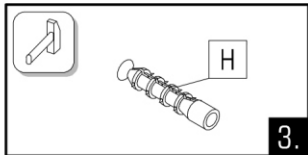
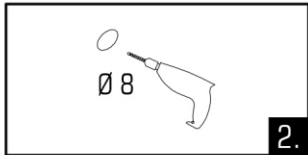
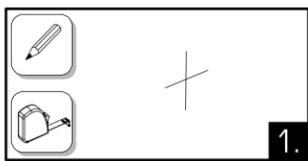

**Upozornenie!** Pevnosť steny sa musí pred montážou bezpodmienečne skontrolovať. Univerzálne hmoždinky, ktoré sú obsiahnuté v balení, používajte jedine pre pevné murivo ako je betón/tehla. Hmoždinky sa nesmú používať v prípade ľahkého stavebného muriva, dutina tehla, u sádkartónových dosiek alebo iných konštrukcií rámu. U týchto murív je nutné použiť špeciálne hmoždinky! Tieto je možné dostať v špeciálnych predajniach so stavebným materiálom (stavebniny). Pri nedodržaní pokynov nepreberajú výrobcovia/predajci a dodávateľa zodpovednosť za vzniknuté škody.

**Upozornění!** Před montáží je nutné zkontrolovat stav stěny. Přiložené univerzální hmoždinky jsou určeny pouze k použití pro pevné zdivo jako beton/cihly. Hmoždinky do zdi se nesmí používat u dutinová cihla, zdiva jako pórovitý stavební kámen, sádkartónová deska nebo jiný měkký materiál. U těchto zdív jsou nutné použít speciální hmoždinky! Jsou k dostání v speciálních prodejnách se stavebním materiálem. Při nedodržení těchto pokynů výrobce/prodejce a dovozce neručí za způsobené škody.

**Paznja!** Prije montaže obvezno provjerite svojstvo zida. Priložene univerzalne tiple namijenjene su isključivo za masivne zidove od betona/opeke. Tiple za masivne zidove ne smiju se koristiti za zidove kao npr šupljina opeka laki sastavni elementi, gips-kartonske ploče ili drugi modularni načini gradnje. Za te zidove potrebne su eventualno specijalne tiple! Iste su dostupne u specijaliziranim trgovinama građevinskim materijalom. U slučaju nepridržavanja prethodno navedenih napomena, proizvođači/trgovac i uvoznik ne preuzimaju odgovornost!





**Achtung!** Die Wandbeschaffenheit ist vor der Montage unbedingt zu prüfen. Die beigelegten Universaldübel sind ausschließlich nur zur Verwendung für festes Mauerwerk wie Beton/Ziegel. Die Mauerdübel dürfen nicht bei Mauerwerk wie Hohlraumziegel, Leichtbausteinen, Gipskartonplatte oder anderer Rahmenbauweise verwendet werden. Bei diesen Mauerwerken sind gegebenenfalls Spezialdübel zu verwenden! Diese sind in einem Fachgeschäft (Baumarkt) erhältlich. Bei Nichteinhaltung wird seitens Produzenten/Händler und Importeur keine Haftung übernommen.

**Prudență!** Zidul trebuie examinat înainte de asamblare prizele de perete sunt adecvate numai pentru utilizarea în zidurile ferme, cum ar fi betonul bloc sau cărămidă. Nu folosiți zidurile zdunilor de perete, cum ar fi cărămida goală, blocul ușor, suprafețe cum ar fi gips-carton sau alia încadrare sisteme. Dacă este cazul, trebuie folosite anumite prize de perete! Acestea sunt disponibile la un magazin specializat (magazin de hardware). În caz de nerespectare, producătorul / vânzătorul cu amănuntul sau importatorul nu își asumă răspunderea.

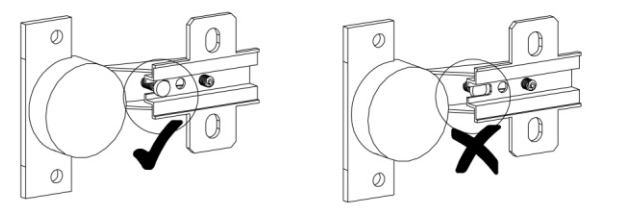
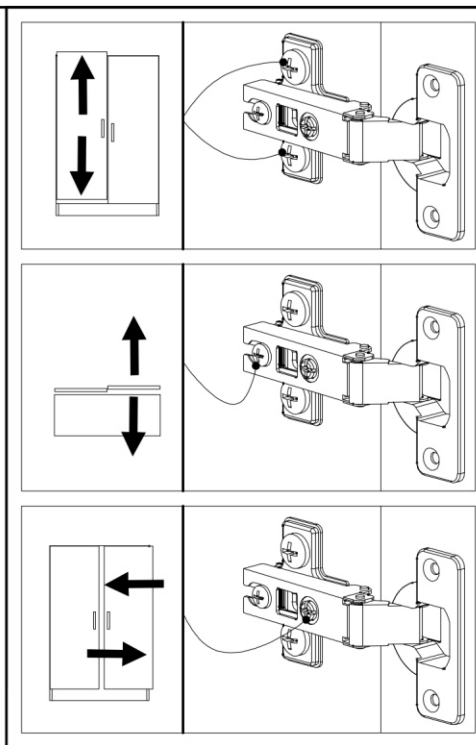
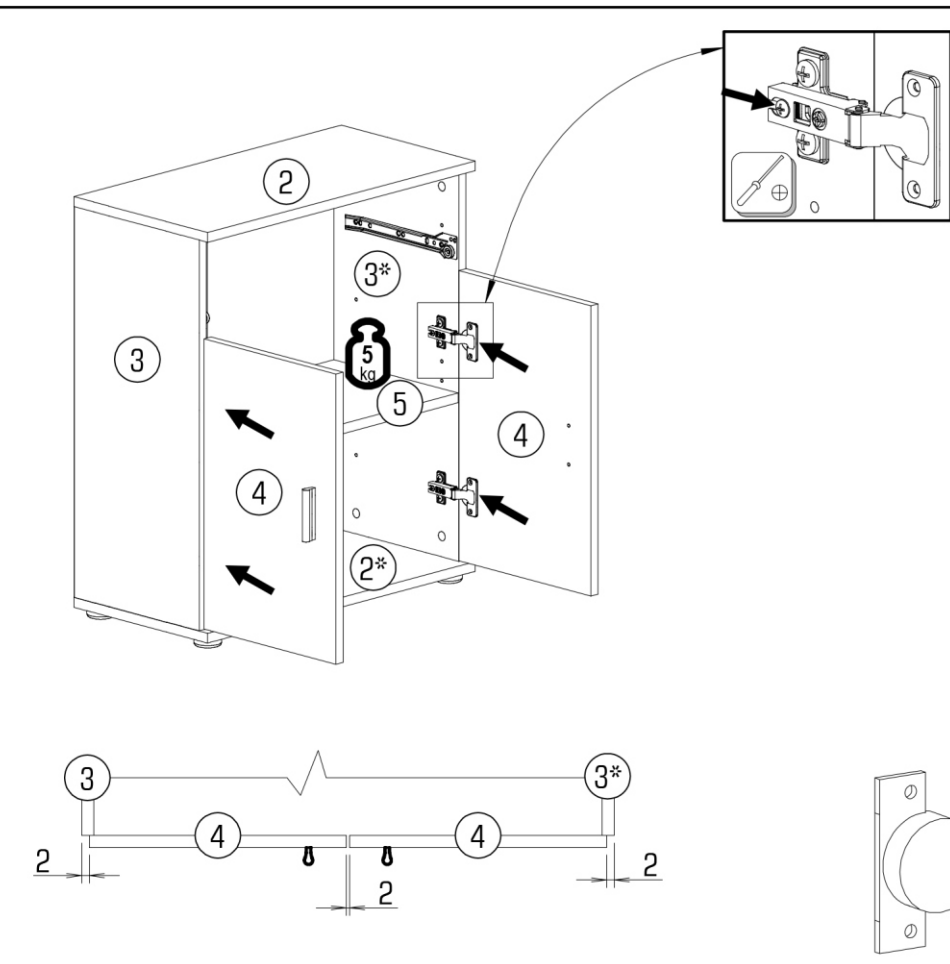
**Uwaga!** Ścianę należy sprawdzić przed montażem. Dołączone uniwersalne kolki rozporowe są odpowiednie tylko do stosowania w mocnych murach, takich jak beton lub cegła. Nie rób z pomocą kółków rozporowych murowanych, takich jak pustak, lekka kostka, powierzchnie takie jak płyty gipsowo-kartonowe lub inne systemy ram. Jeśli dotyczy, muszą to być określone kolki rozporowe być użytym! Są one dostępne w specjalistycznym sklepie (sklepie ze sprzętem) niezgodność, producent / sprzedawca lub importer nie ponoszą odpowiedzialności.

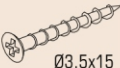
**Vigyázat!** Szerelés előtt a falfelület feltétlenül vizsgálja meg. A mellékelt univerzális tiple kizárólag stabil falazathoz használható mint például beton/tégla. A fali tiple nem használható könnyű építőkövek hez, üreg téglá, gipszkarton lapokhoz vagy más favázás építményekhez. Ezekhez a falfelületekhez csak speciális tiplek használhatóak, melyek szaküzletekben (barkácsáruházakban) beszerezhetőek. Fentiek figyelmen kívül hagyása esetén a gyártó/kereskedő vagy forgalmazó nem vállal felelősséget.



	$\varnothing 3,5 \times 15$		$\varnothing 3,5 \times 16$		$\varnothing 7 \times 50$		L=250mm
B	4x	D	4x	U	4x	Z2	1x

