

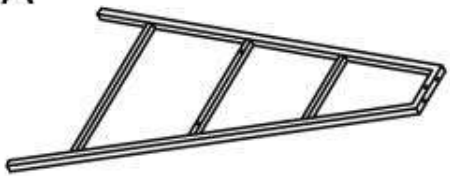











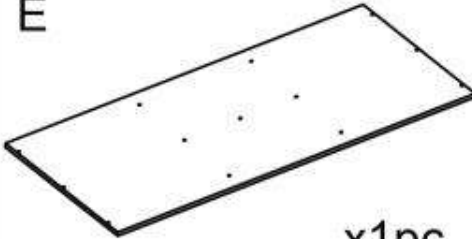
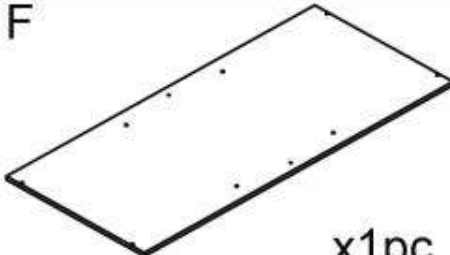

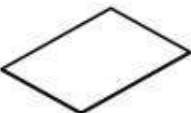







B-48

<p>A</p>  <p>x2pcs</p>	<p>B</p>  <p>x1pc</p>	<p>C</p>  <p>x2pcs</p>	<p>D</p>  <p>x2pcs</p>		
<p>E</p>  <p>x1pc</p>	<p>F</p>  <p>x1pc</p>	<p>G</p>  <p>x4pcs</p>	<p>H</p>  <p>x2pcs</p>		
<p>I</p>  <p>x2pcs</p>	<p>J</p>  <p>x2pcs</p>	<p>K</p>  <p>x4pcs</p>	<p>L</p>  <p>x1pc</p>		
<p>M</p>  <p>x2pcs</p>	<p>N</p>  <p>M6x40mm x6pcs</p>	<p>O</p>  <p>M6x35mm x4pcs</p>	<p>P</p>  <p>M6x30mm x8pcs</p>	<p>Q</p>  <p>M6x12mm x5pcs</p>	<p>R</p>  <p>x8pcs</p>
<p>S</p>  <p>x24pcs</p>	<p>T</p>  <p>x24pcs</p>	<p>U</p>  <p>x4pcs</p>	<p>V</p>  <p>x2pcs</p>	<p>W</p>  <p>x1pc</p>	



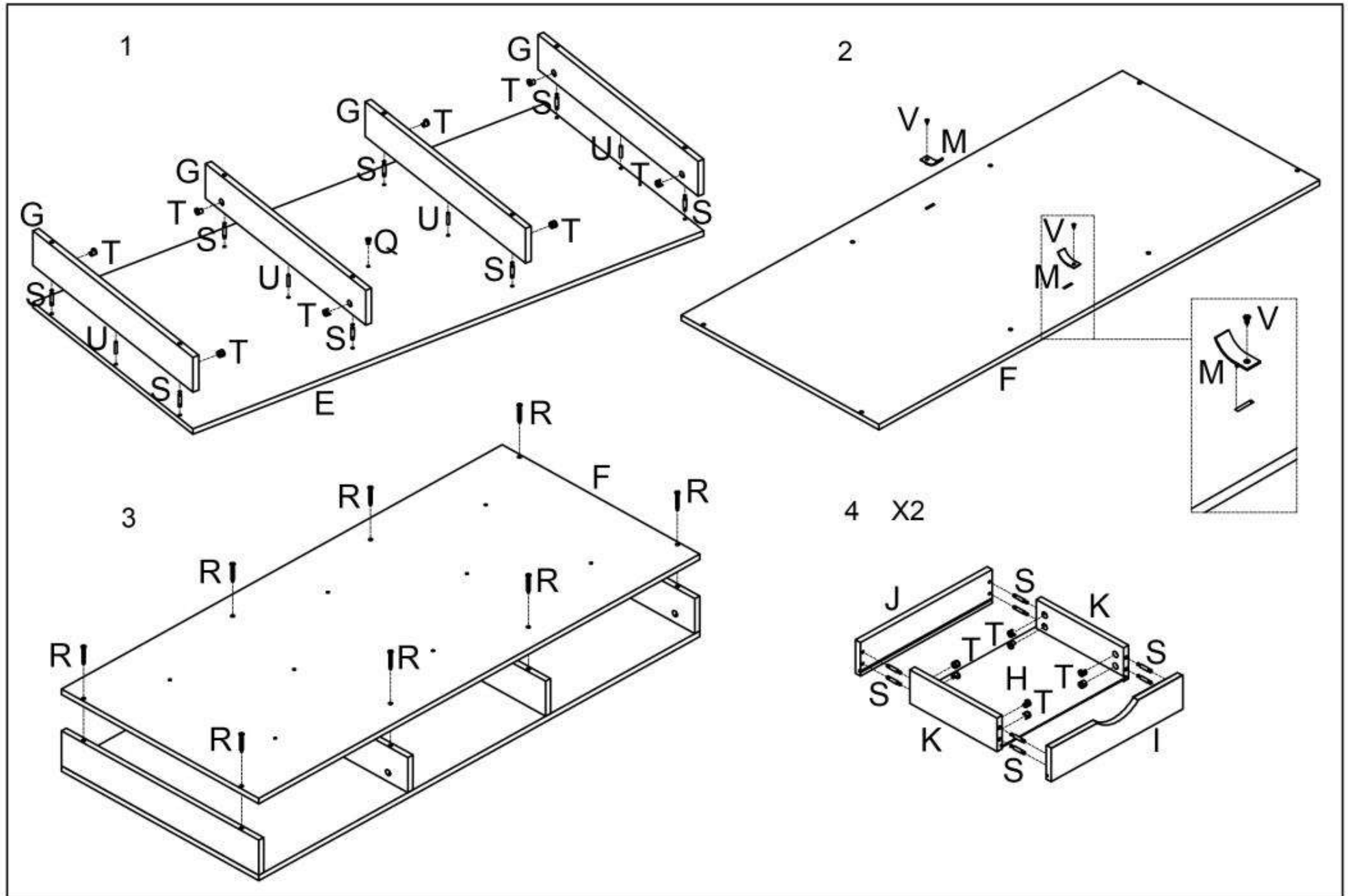
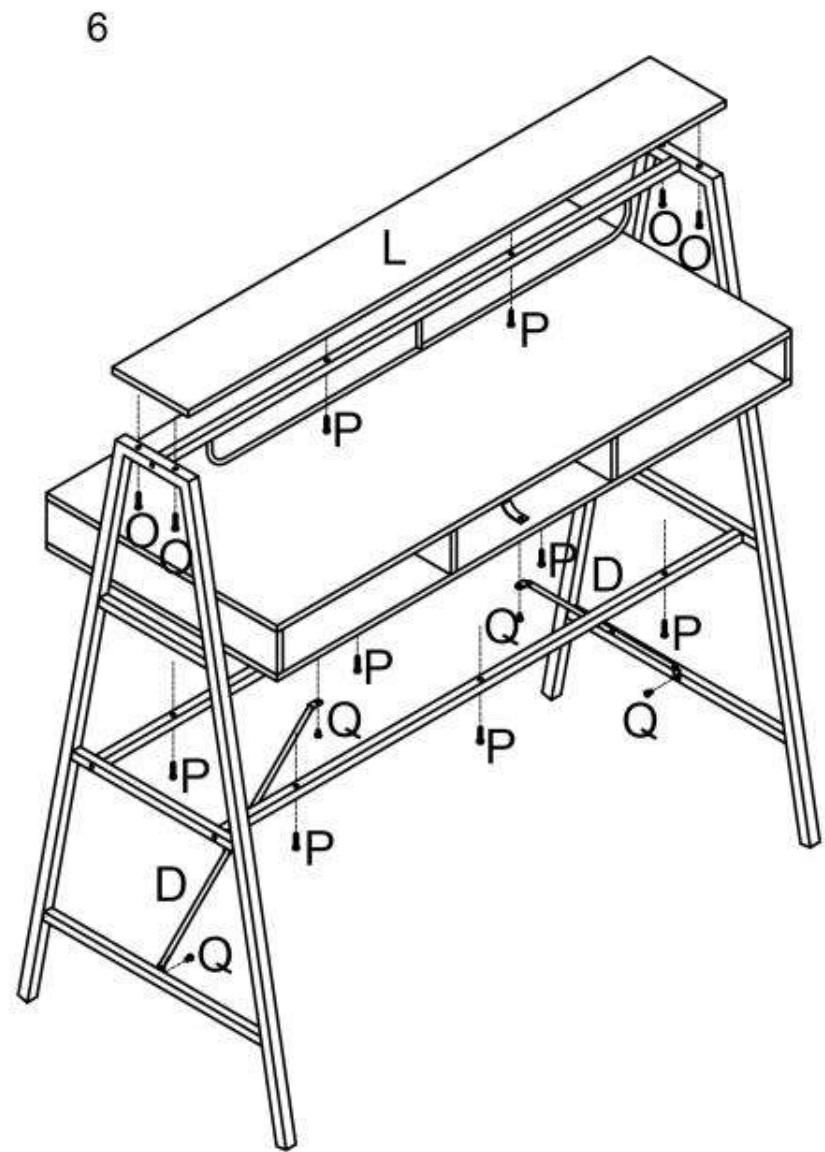
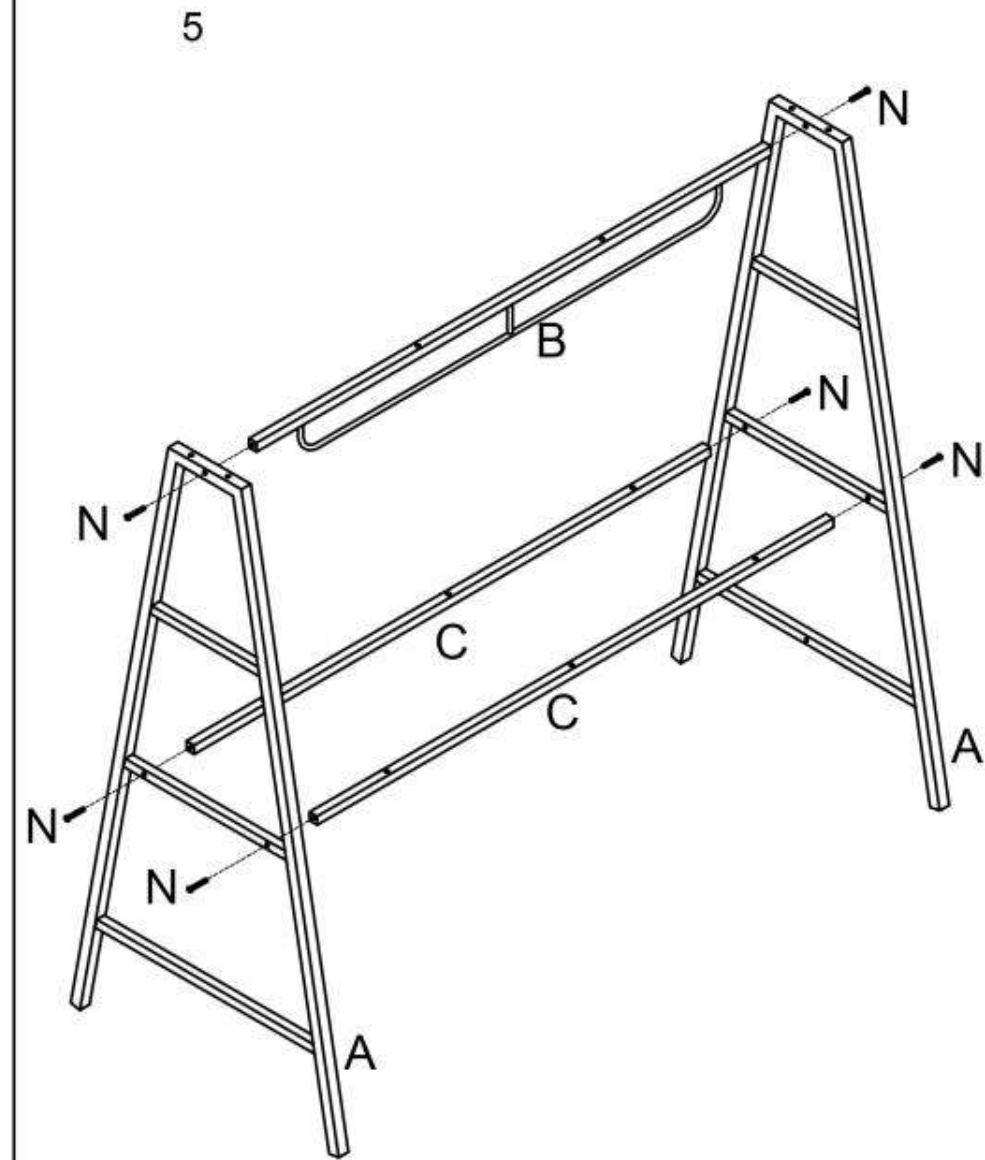

7

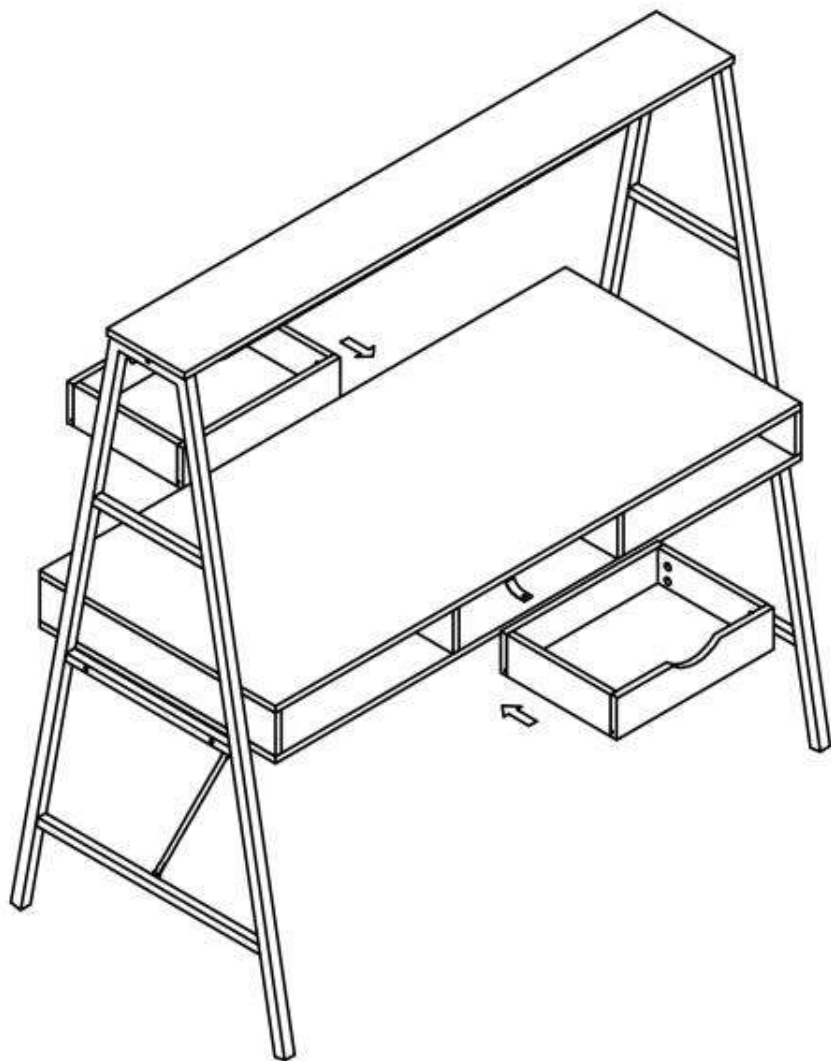

8

