

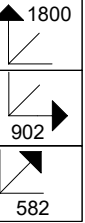

BETTY 04
BE04-002-00



V PRÍPADE REKLAMÁCIE JE POTREBNÉ NAHLÁSIŤ
 VÝROBNÉ ČÍSLO VIDITEĽNÉ NA ETIKETE

A 18x	B 10x	C 10x	D 2x	E 6x	F 30x	G 5x	H 12x	J 2x	K 4x

L 4x	M 8x	N 1x	P 8x

1h 30min		4	5,5 x 125	≤ 0,5 kg	3m	

ID	ID	Part	Qty	Boxes
01705	②	1784*580*16	1x	1/3
01706	③	1784*580*16	1x	1/3
01698	④	868*103*16	1x	3/3
01707	⑤	868*558*16	1x	3/3
01708	⑥	902*582*16	1x	3/3
01701	⑦	1658*440*16	2x	2/3
01709	⑧	1665*487*16	1x	2/3
01703	⑨	1687*442*2,5	2x	1/3
01710	⑩	426*485*16	1x	3/3
01711	⑪	426*485*16	1x	3/3

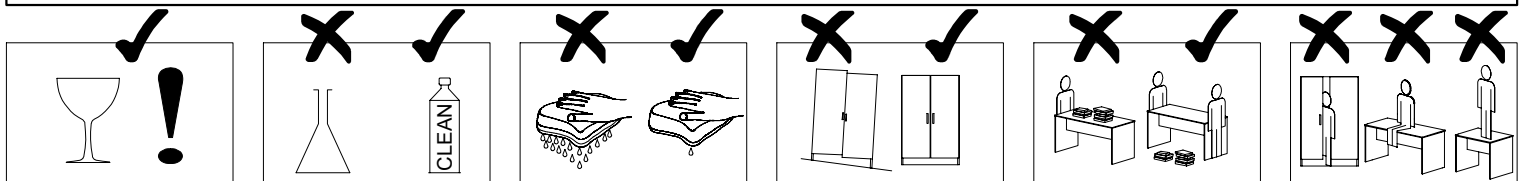
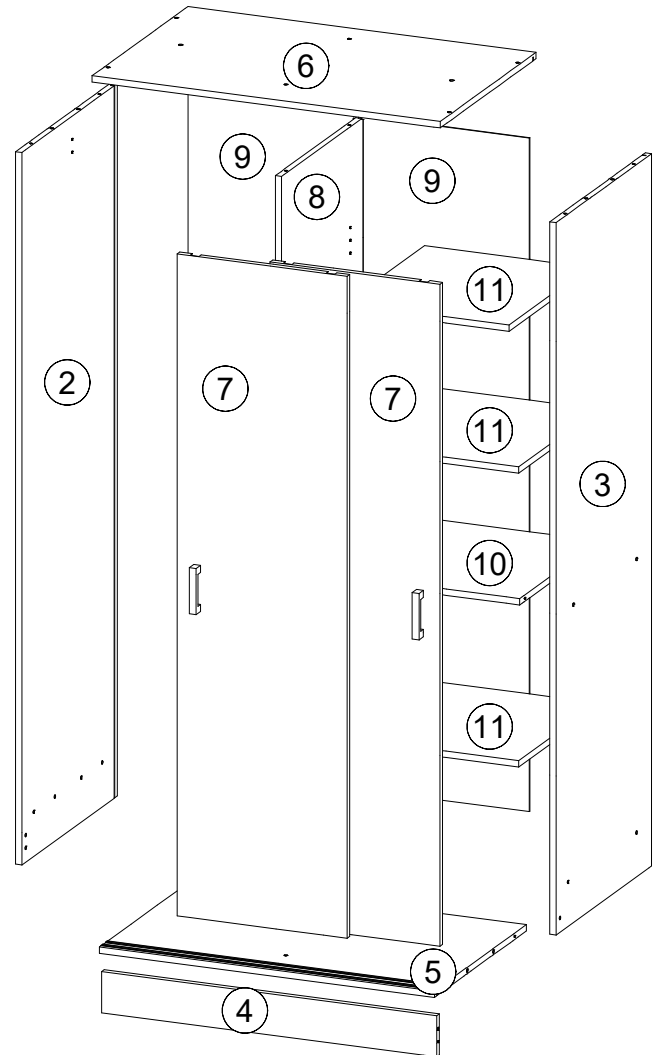
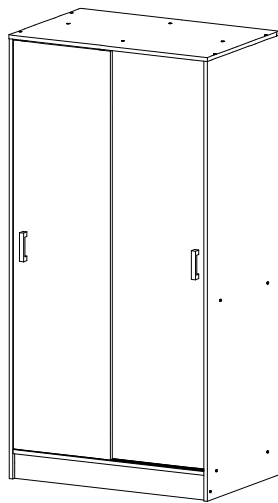

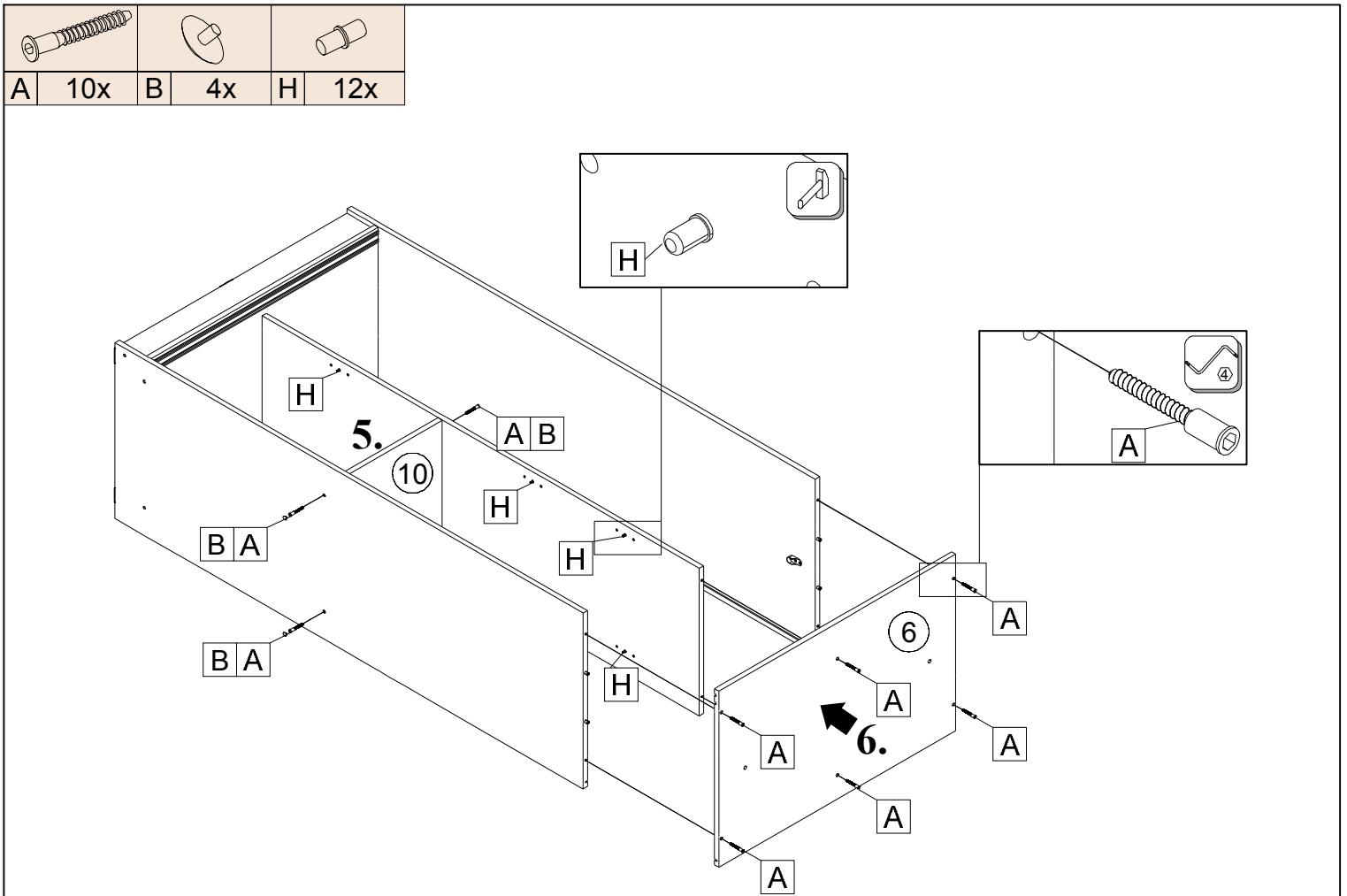
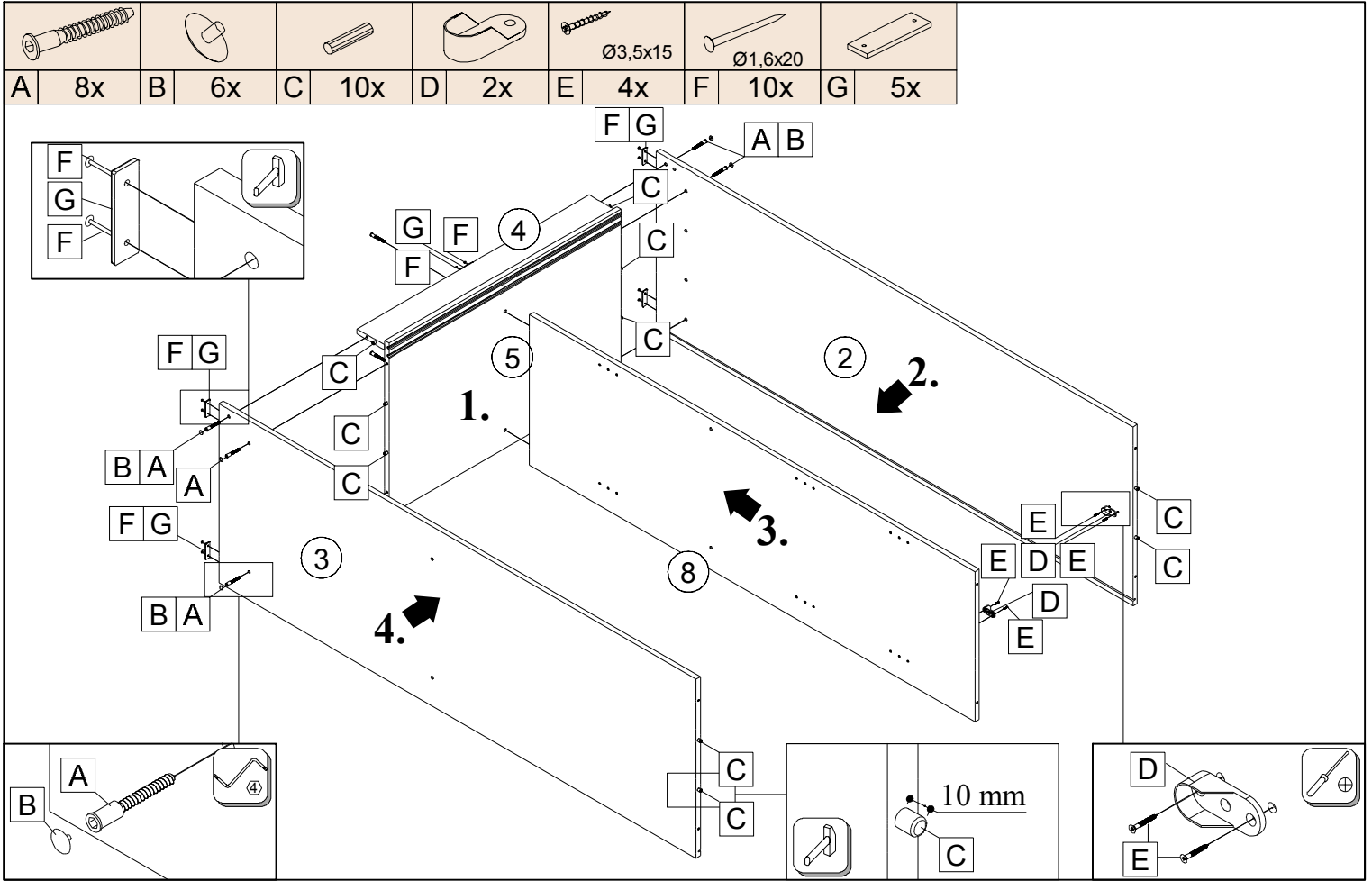

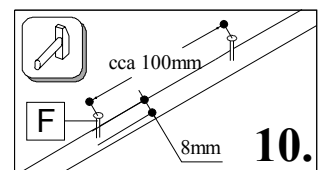
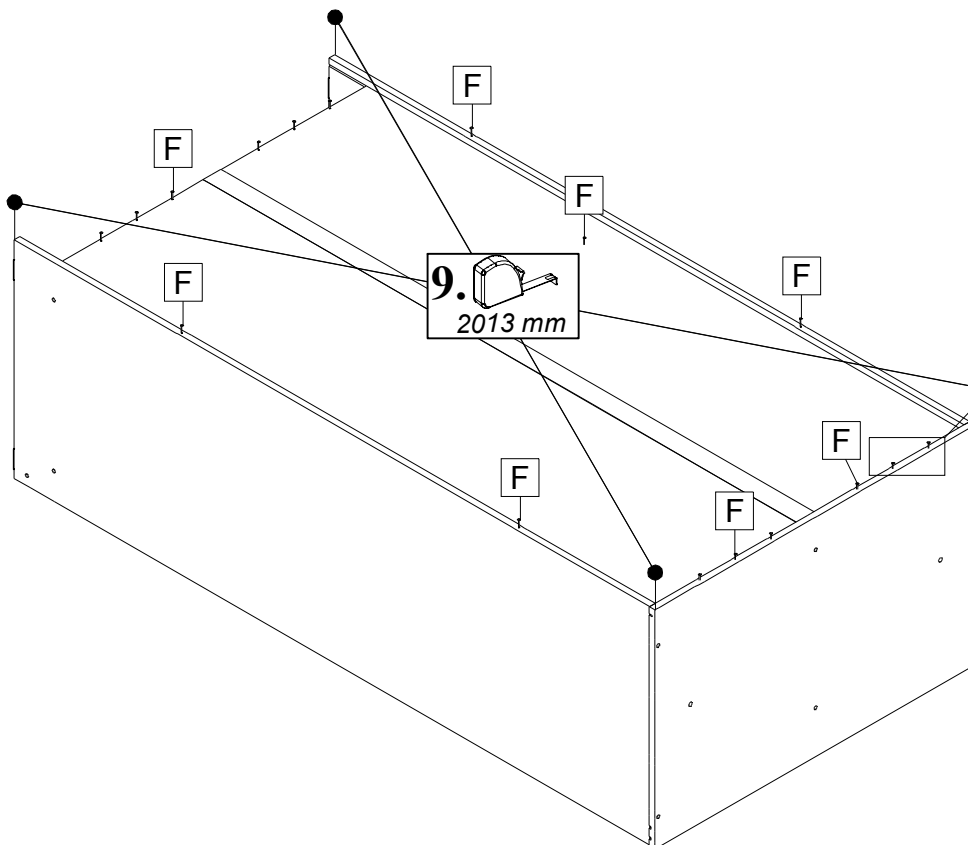
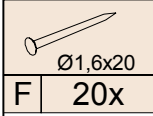
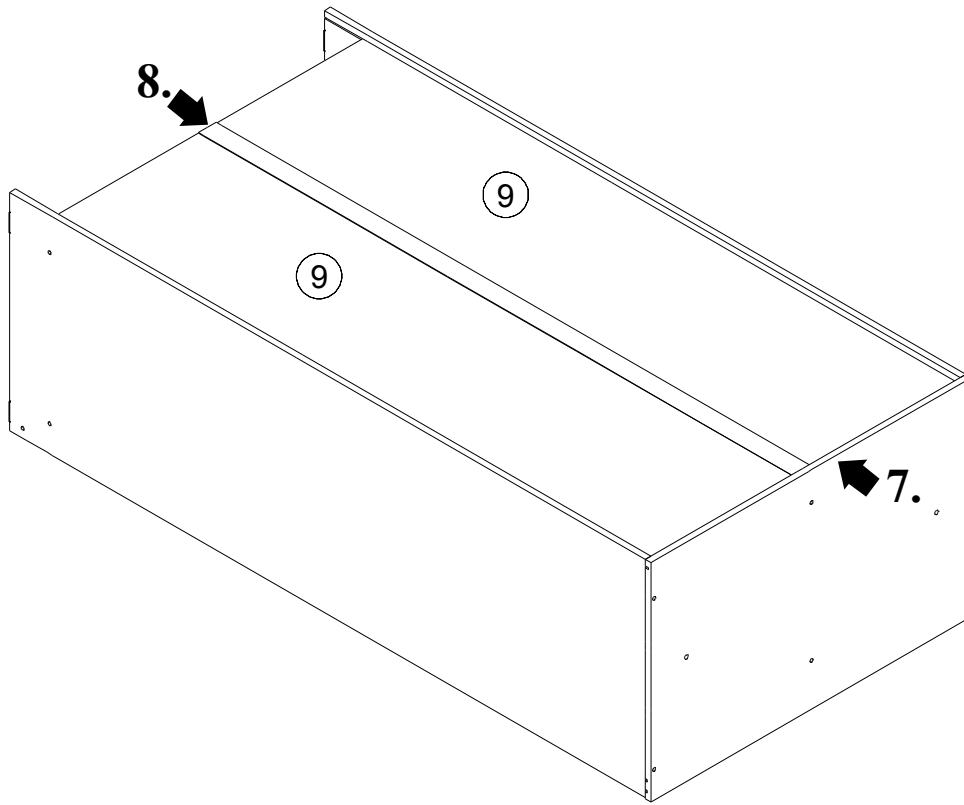

10.

