



















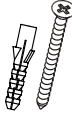













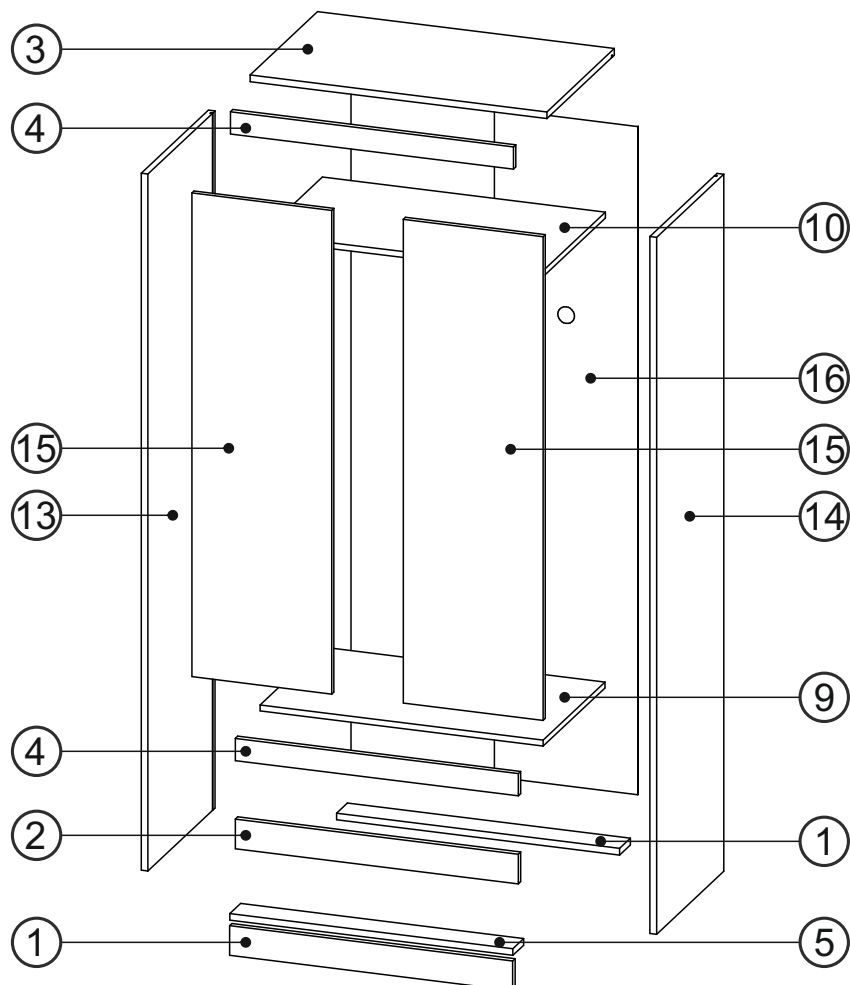
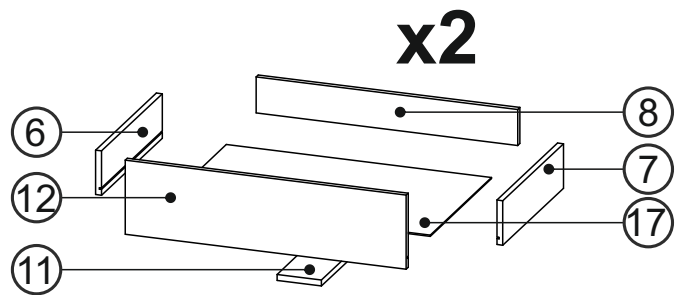

A0  ø8x30 x46	B0  ø 7mm x8	B1  ø7x50 x8	C0  ø16mm x20	C1  18 mm x6	C2  x20	C7  16 mm x14	D0  3x15 x30	D5  3,5x16 x26	D14  4x35 x4	D21  5x13 x17
E0  8x50 x1	J4  x6	J6  x6	K  4mm x1	M1  x30	N3  L-450 x2	O0  x2	P0  x1	S0  L-756 x1	T3  x6	T18  x20
U0  x4	U12  x2									

①	764	80	18	x2	1/2
②	764	80	18	x1	1/2
③	801	500	18	x1	1/2
④	764	60	18	x1	1/2
⑤	764	80	18	x1	1/2
⑥	450	120	16	x2	1/2
⑦	450	120	16	x2	1/2
⑧	706	97	16	x2	1/2
⑨	764	458	16	x1	1/2
⑩	764	450	16	x1	1/2
⑪	450	120	16	x2	1/2
⑫	758	200	16	x2	1/2

⑬	1882	498	18	x1	2/2
⑭	1882	498	18	x1	2/2
⑮	377,5	1306	16	x2	2/2
⑯	1804	774	3	x1	2/2
⑰	716	455	3	x2	2/2
					1/2



1

A0  ø8x30 x10	C1  18 mm x2	C2  x14	C7  16 mm x4	D5  3,5x16 x2	D21  5x13 x16	J6  x6	N3  L-450 x2	O0  x2	T3  x4
-----------------------------------------------------------------------------------------------------------------------	----------------------------------------------------------------------------------------------------------------------	--------------------------------------------------------------------------------------------------------------	----------------------------------------------------------------------------------------------------------------------	-----------------------------------------------------------------------------------------------------------------------	-----------------------------------------------------------------------------------------------------------------------	---------------------------------------------------------------------------------------------------------------	------------------------------------------------------------------------------------------------------------------------	---------------------------------------------------------------------------------------------------------------	---------------------------------------------------------------------------------------------------------------

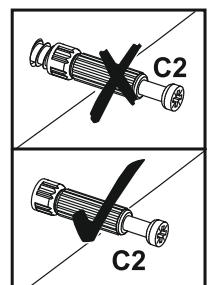
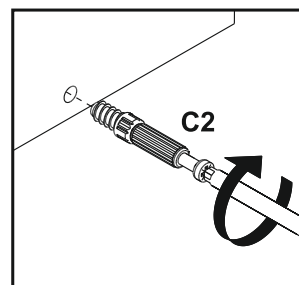
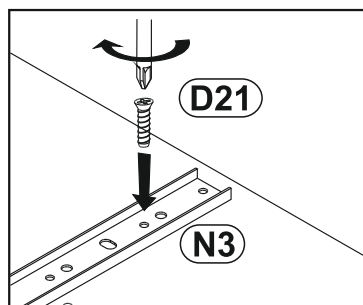
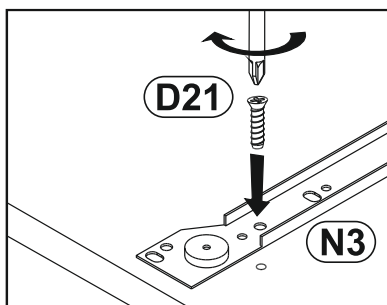
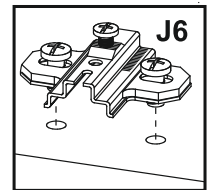
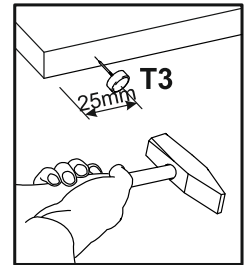
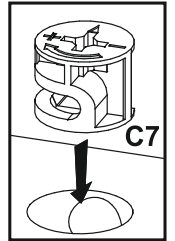
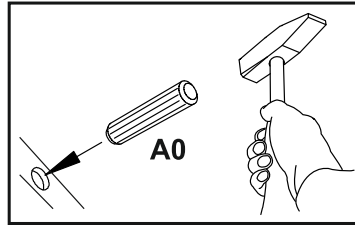
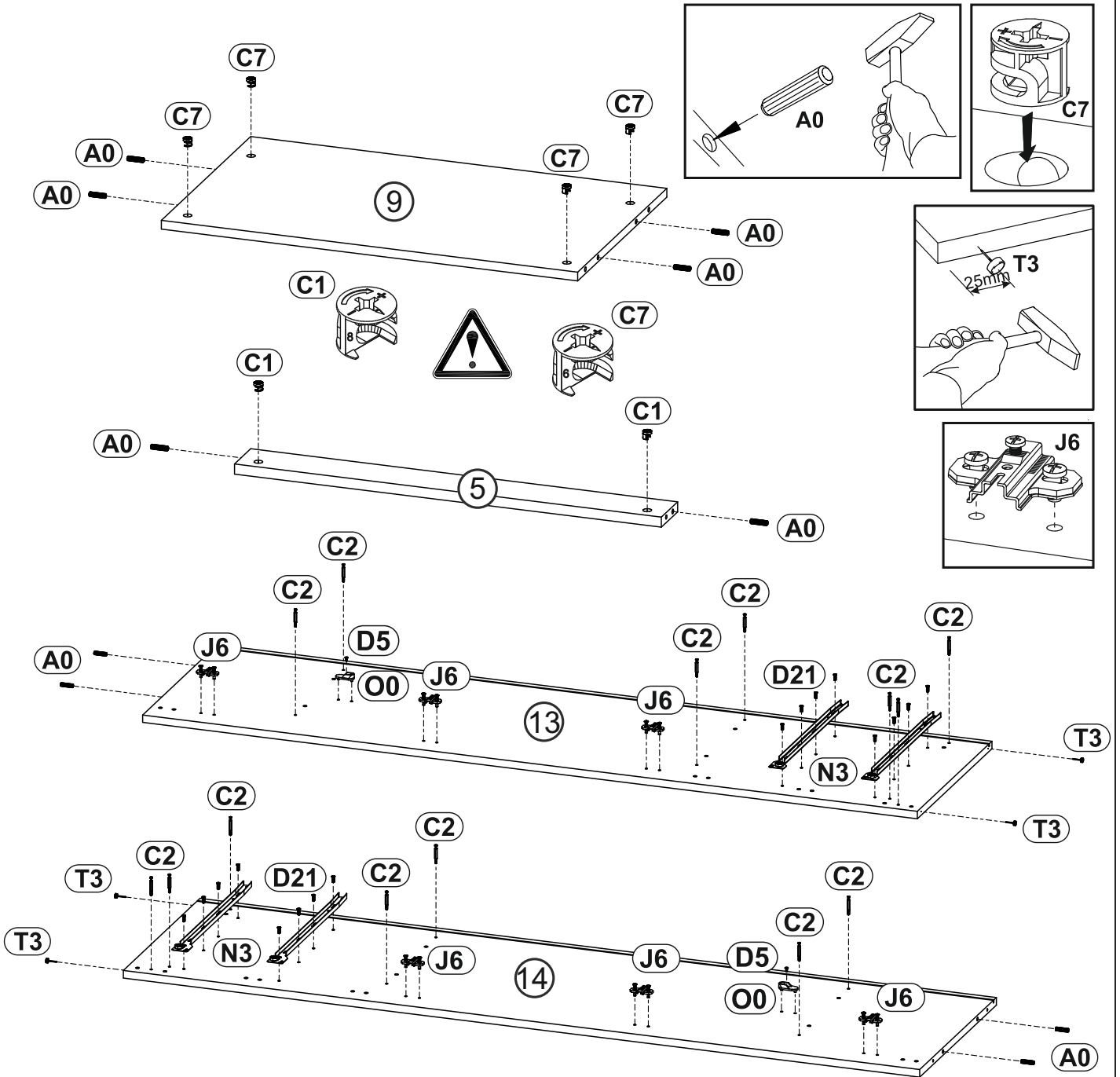

2

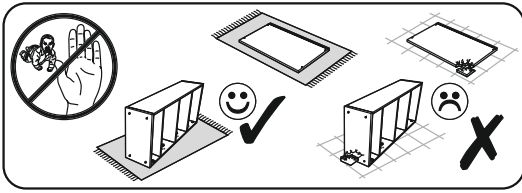

A0
∅8x30
x20

C1
18 mm
x4

C7
16 mm
x4

D5
3,5x16
x12

J4
x6

T3
x2

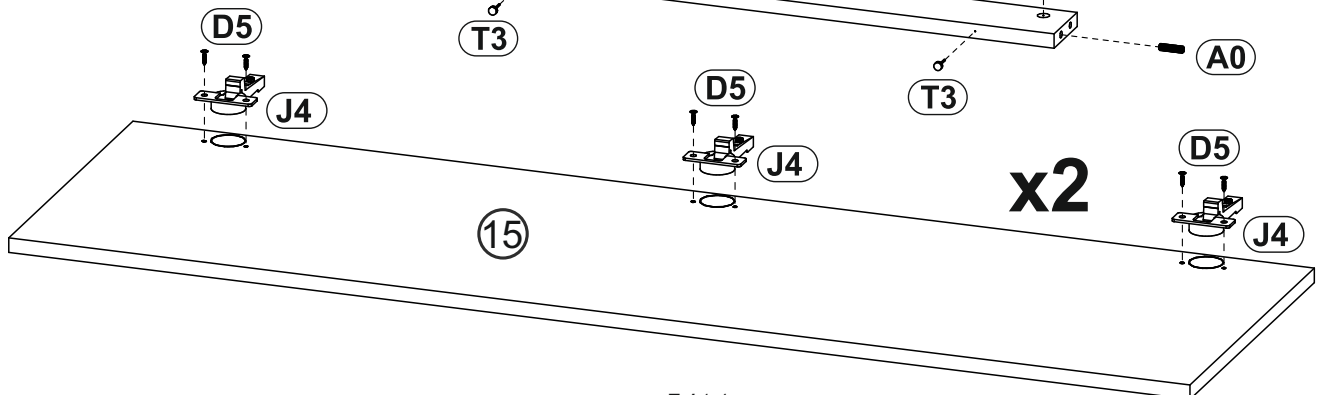
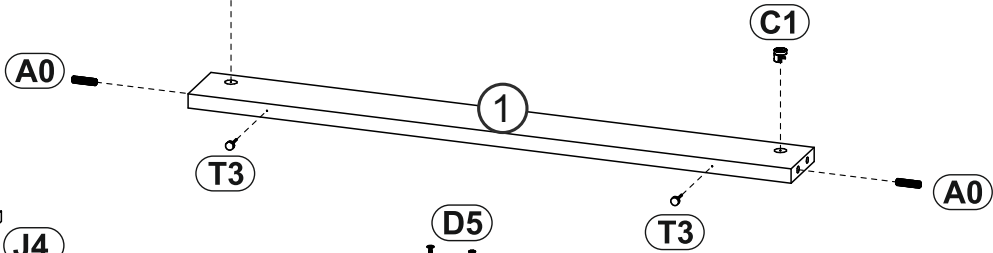
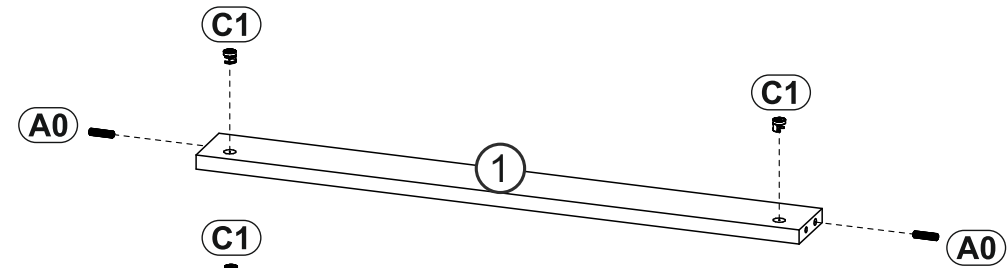
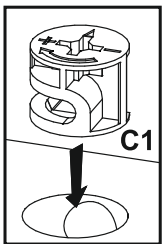
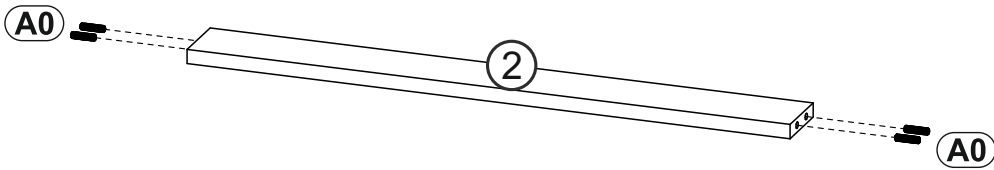
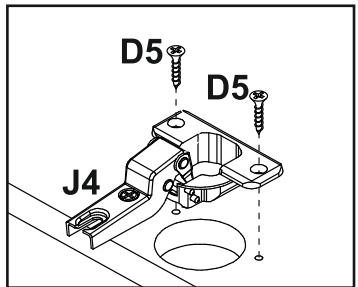
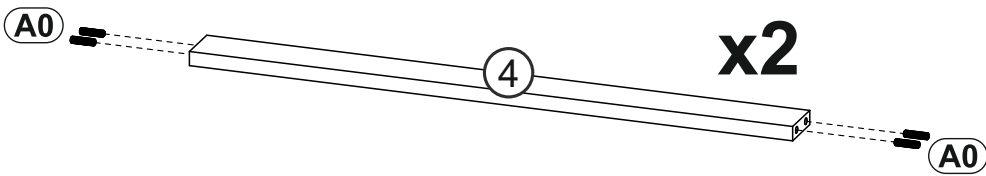
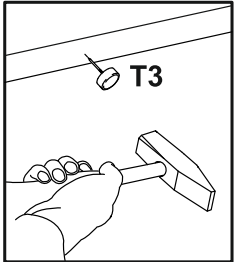
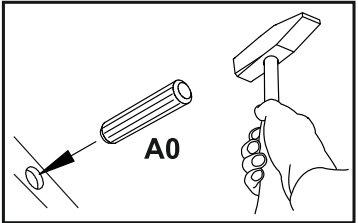
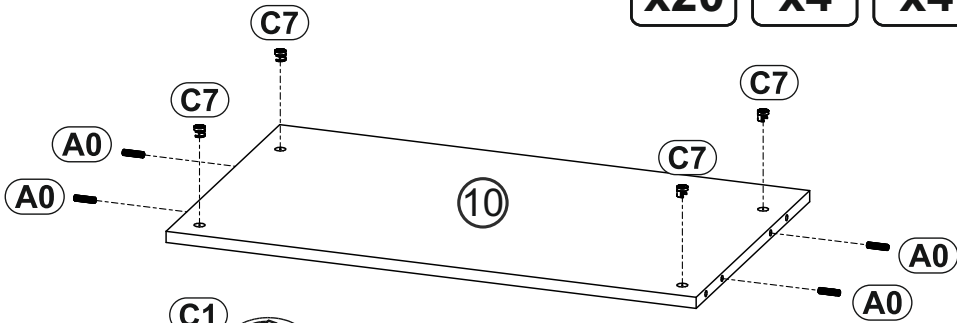

3

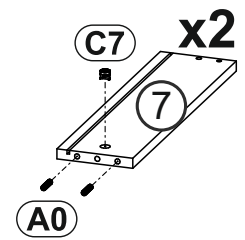
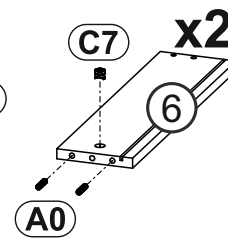
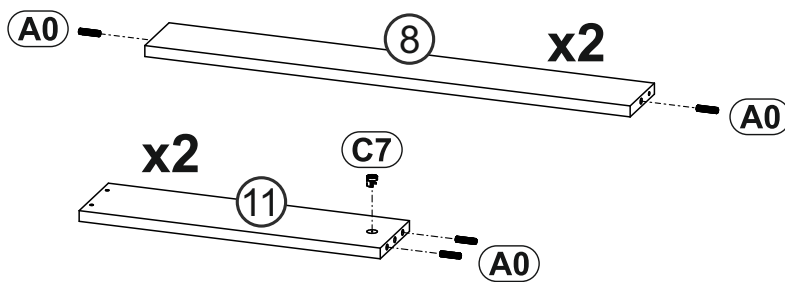
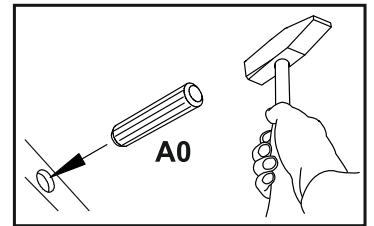
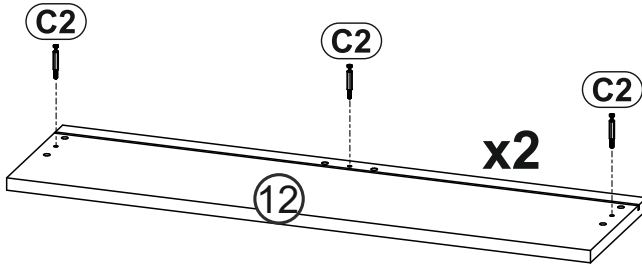
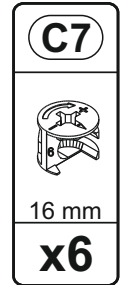
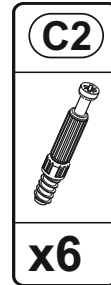
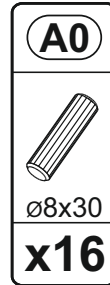
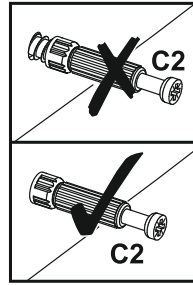
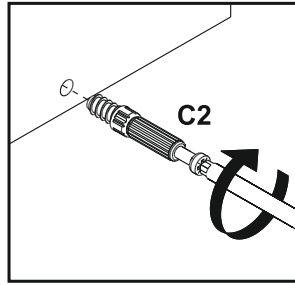
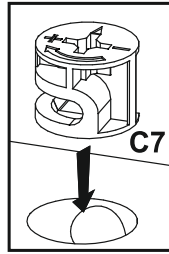

4

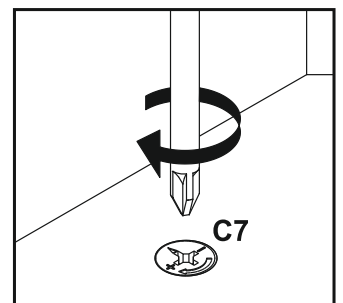
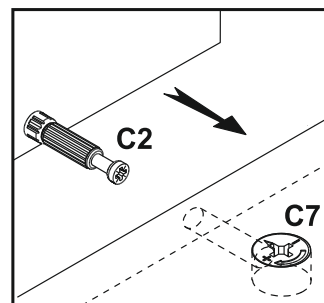
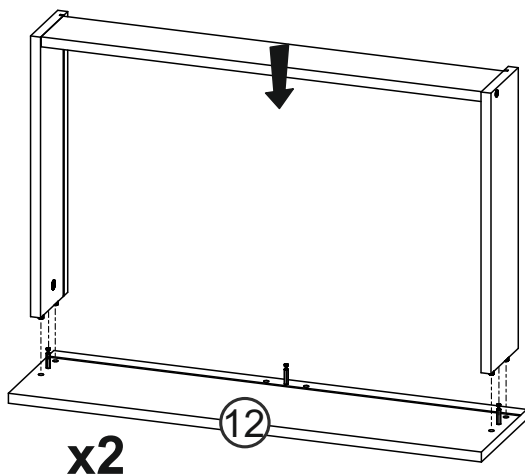
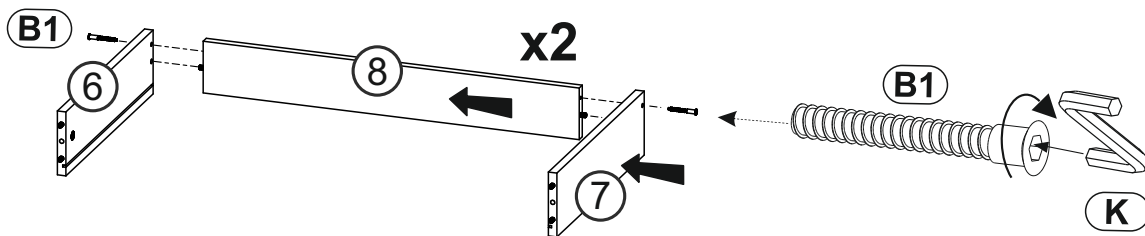
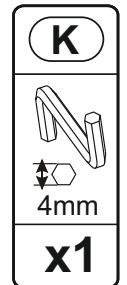
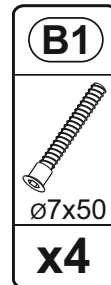
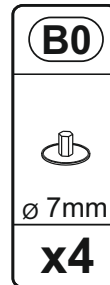
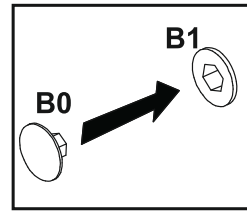
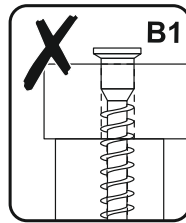
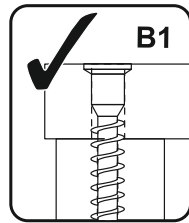

5

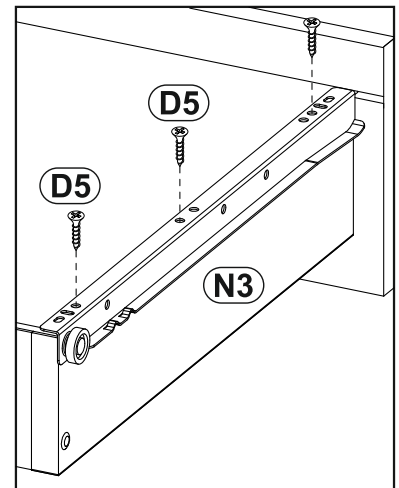
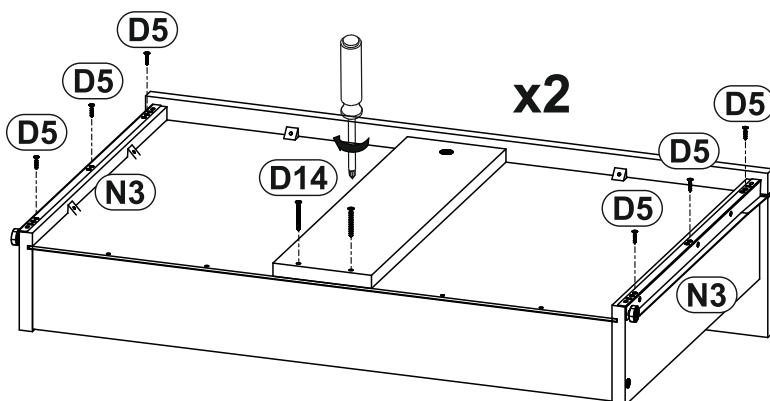
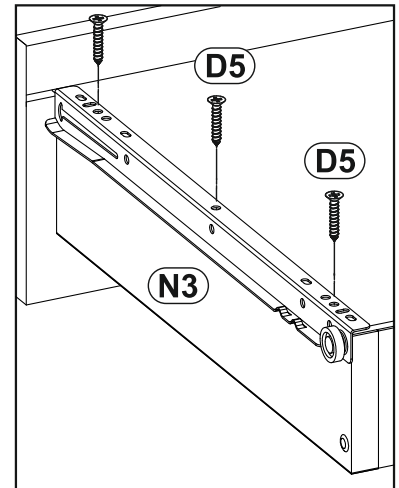
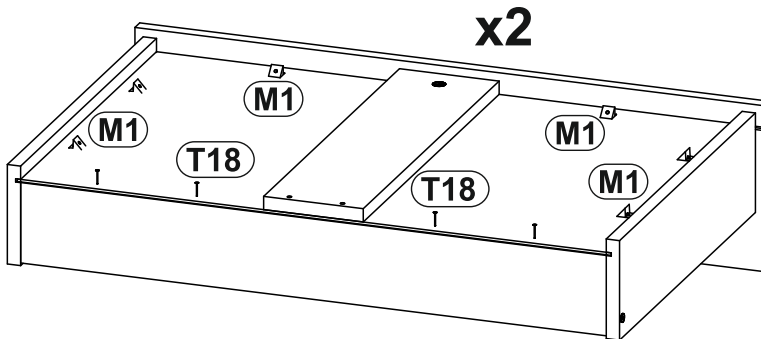
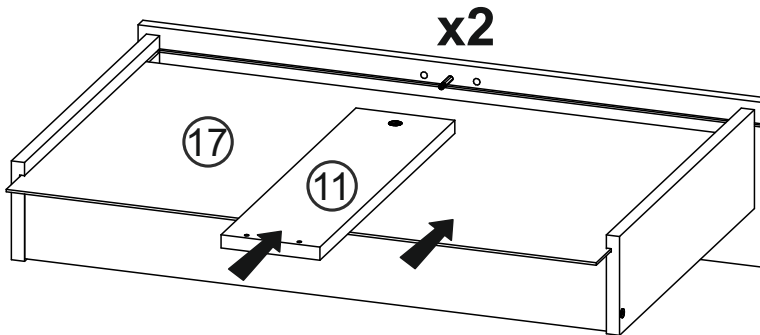
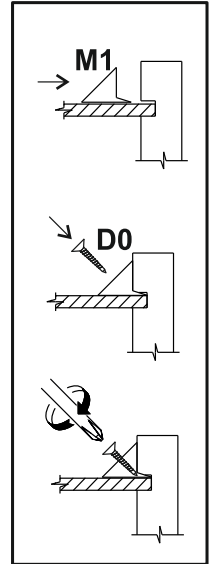
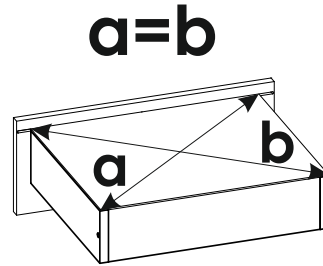
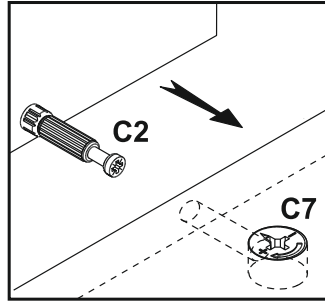
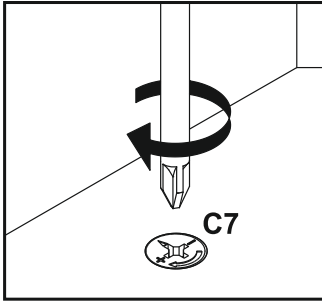
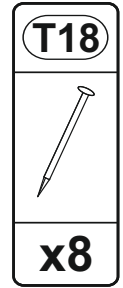
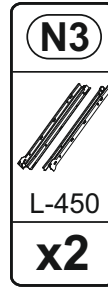
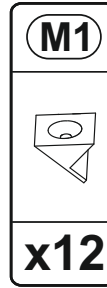
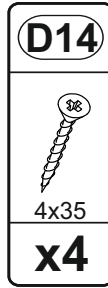
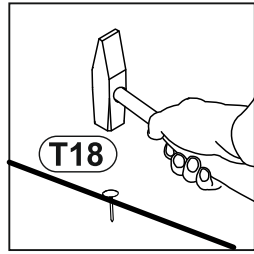

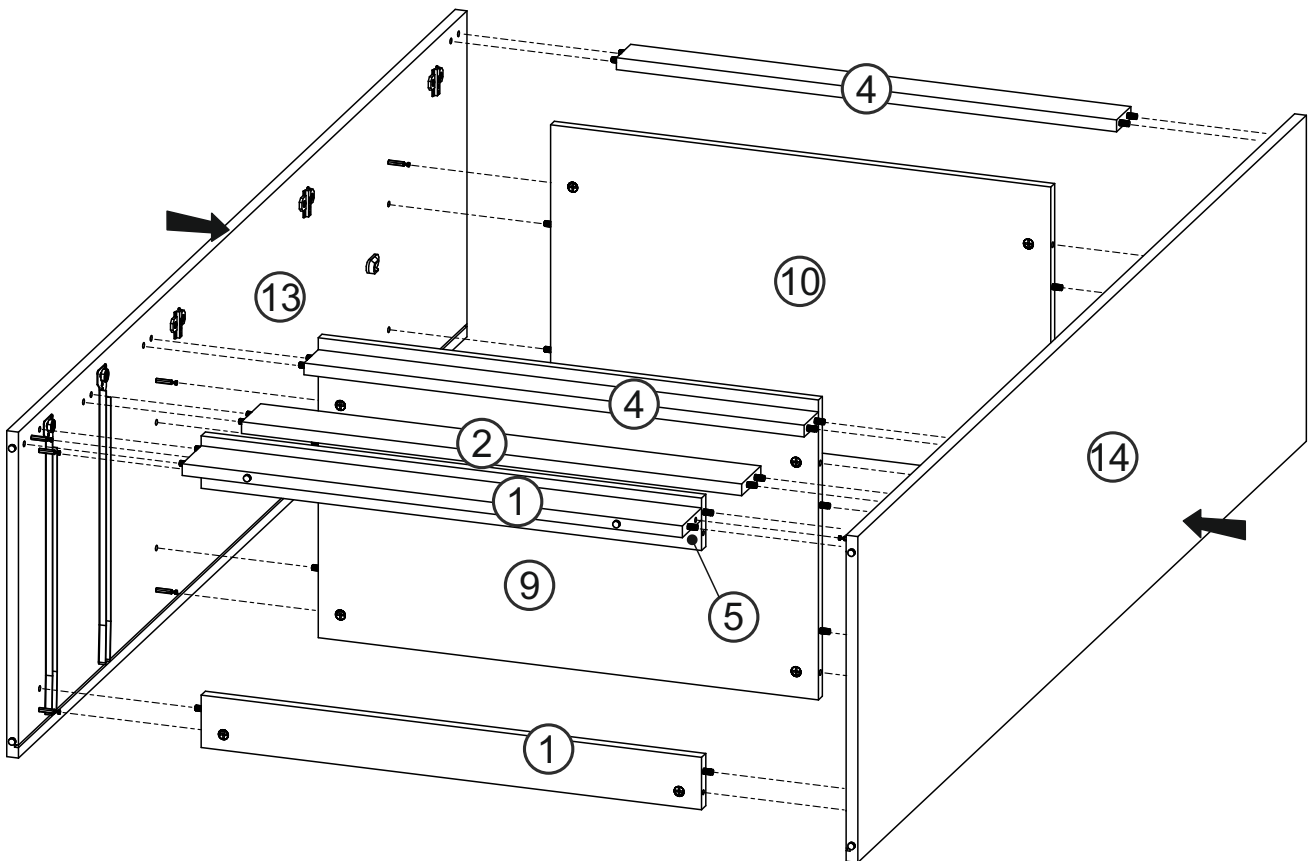
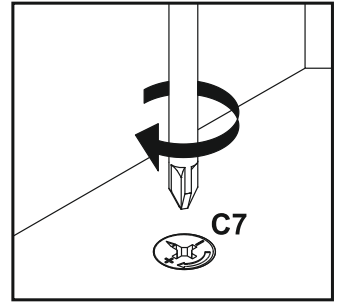
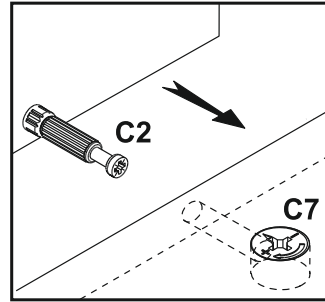
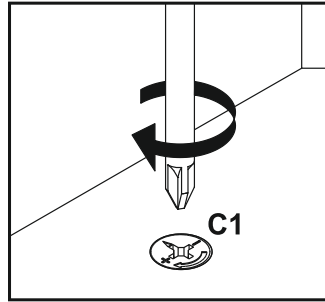
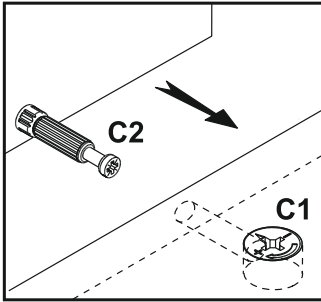

6

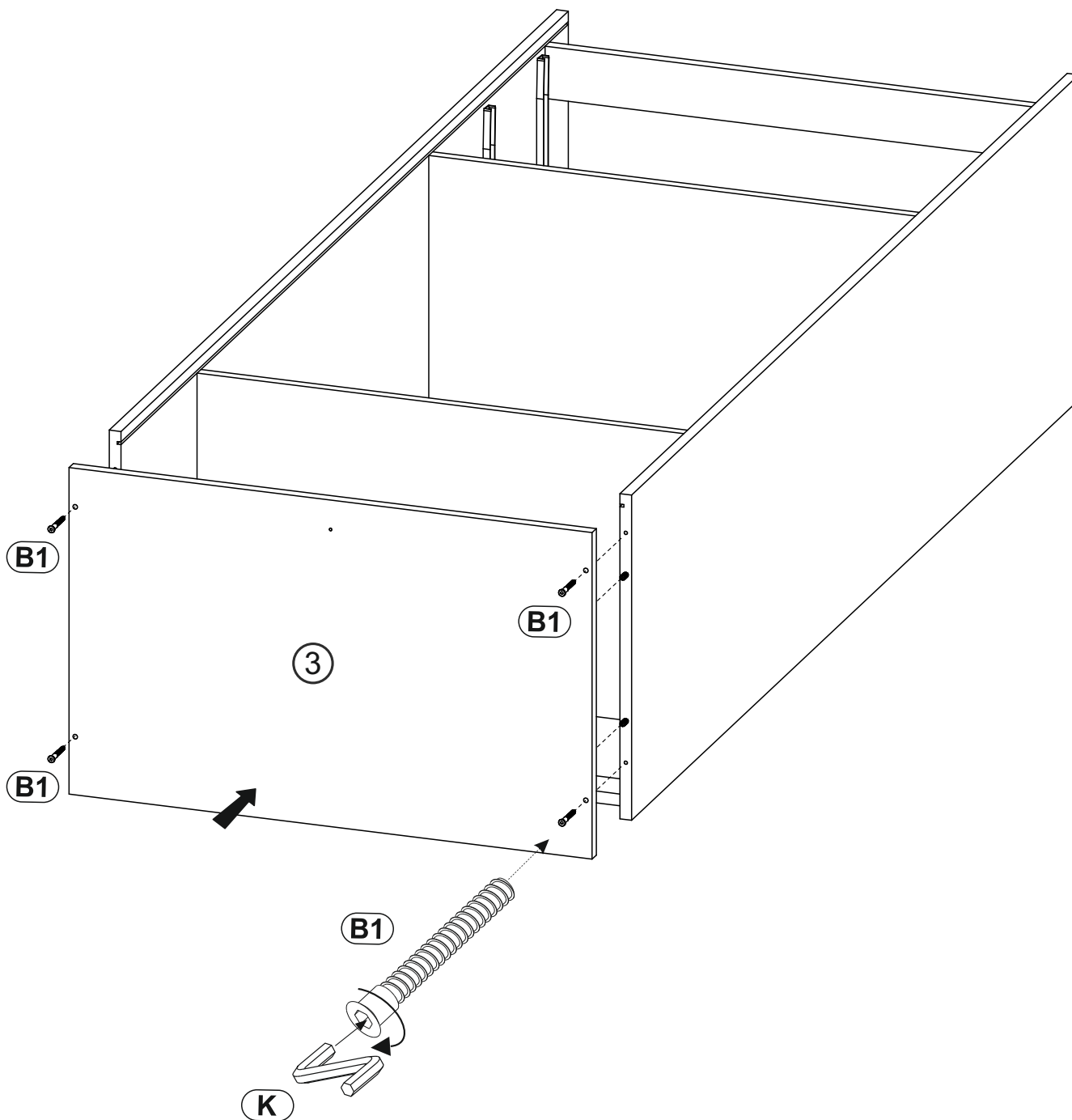
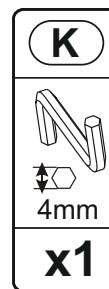
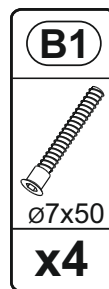
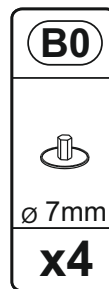
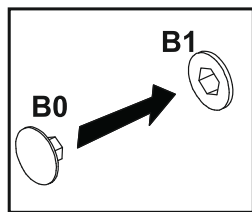
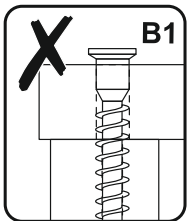
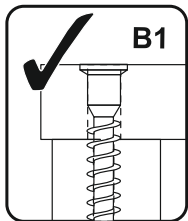

7



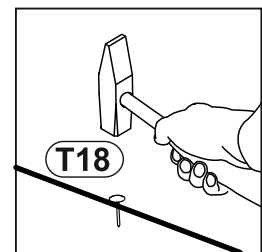
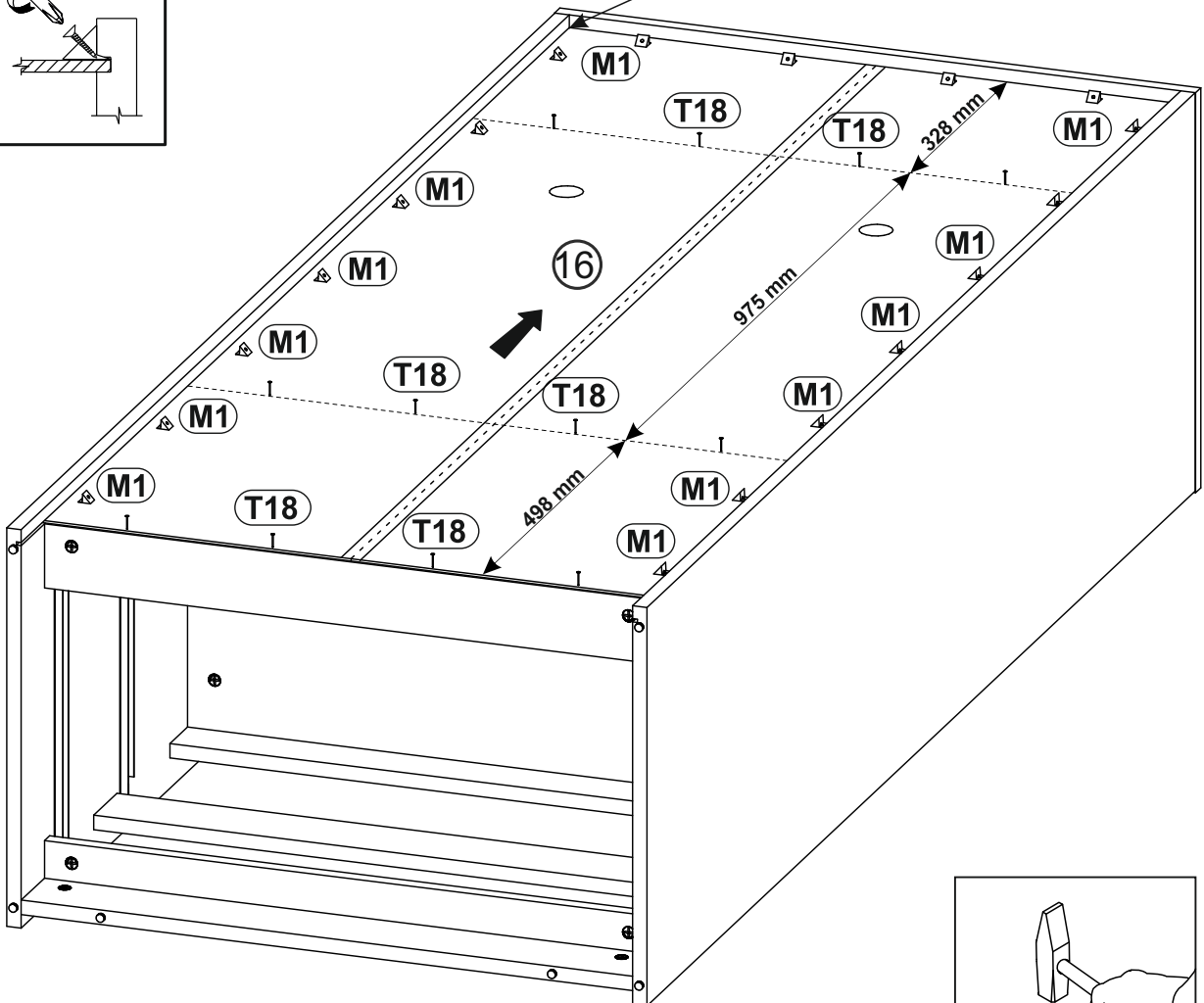
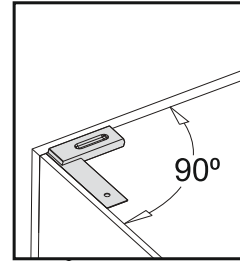
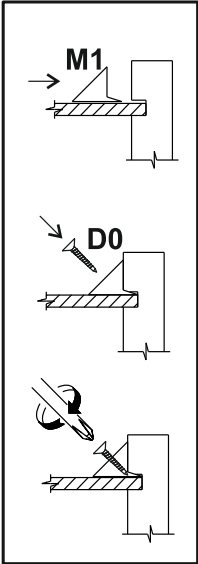

8

D0	M1	T18
		
3x15		
x18	x18	x12



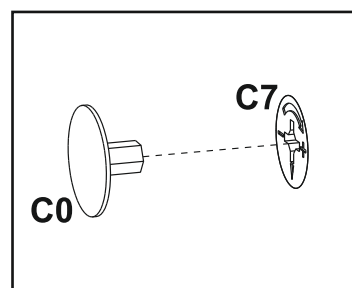
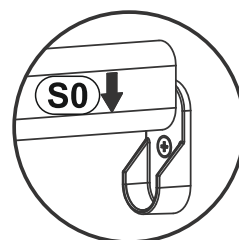
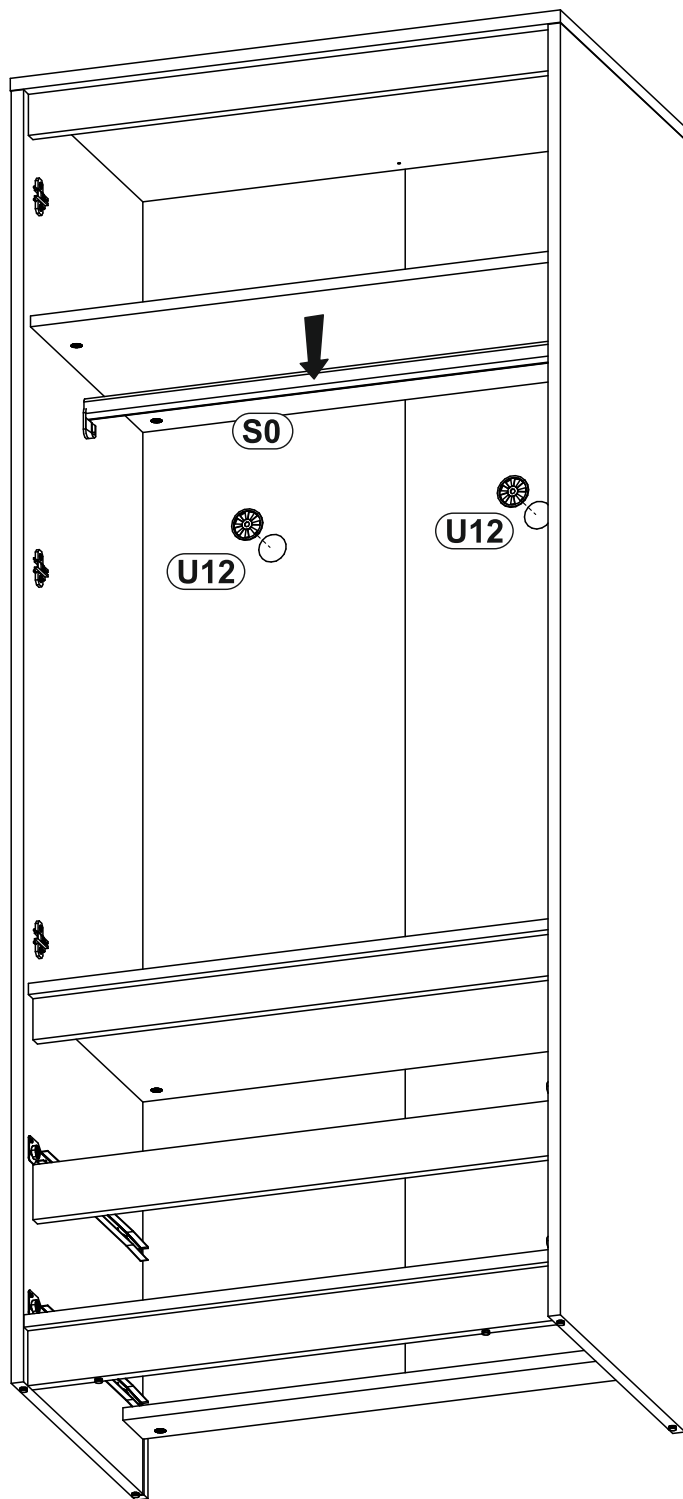

9

C0	S0	U12
		
ø16mm	L-756	
x16	x1	x2

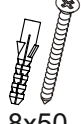
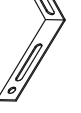

10

C0	D21	E0	P0
			
ø16mm	5x13	8x50	
x4	x1	x1	x1

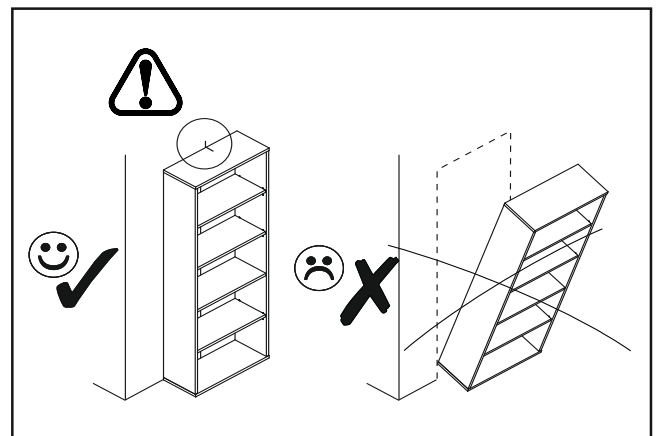
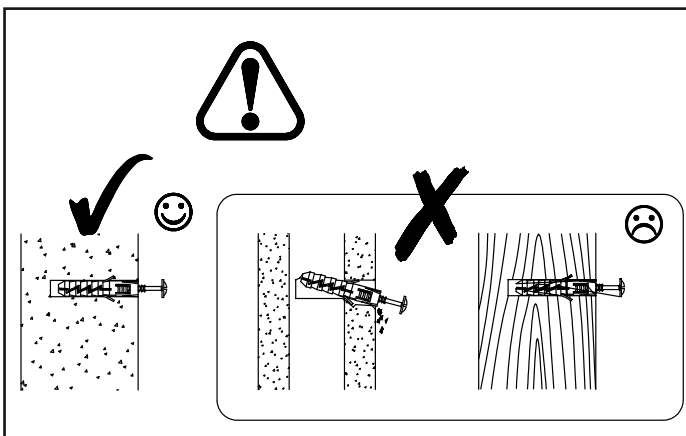
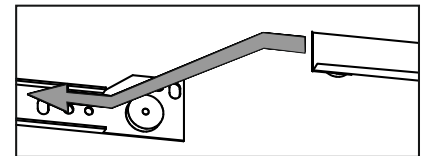
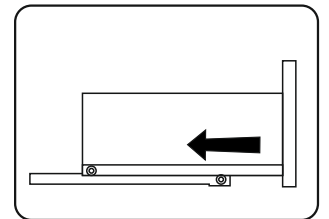
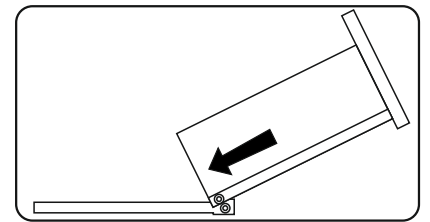
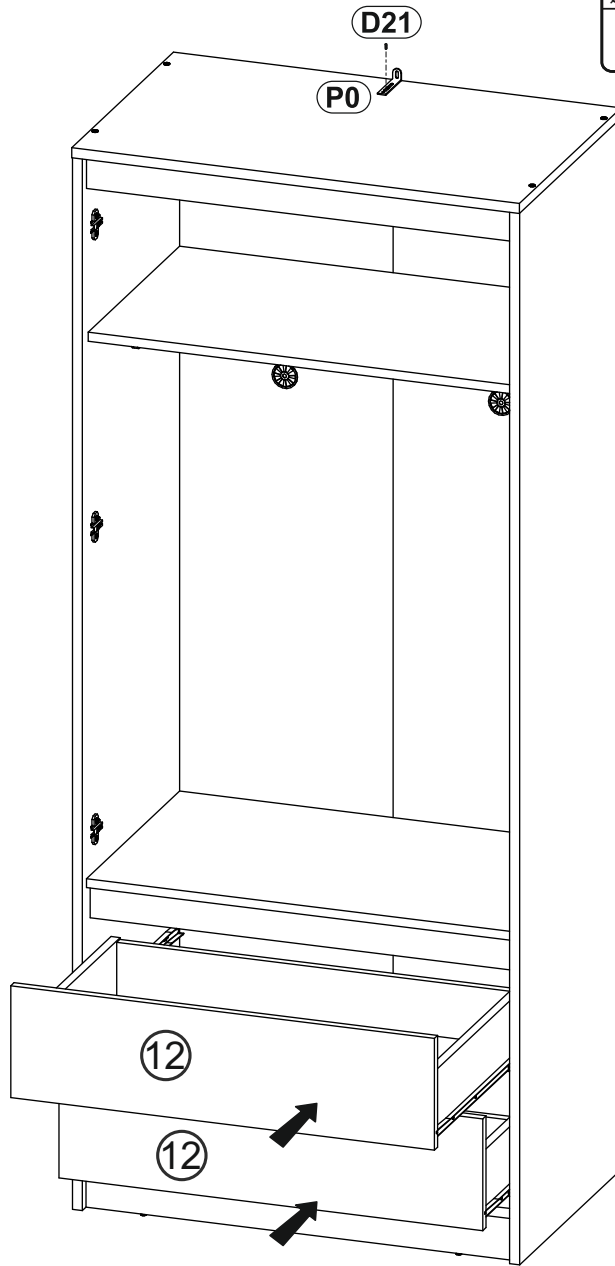
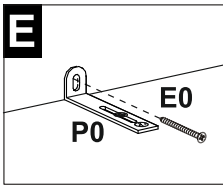
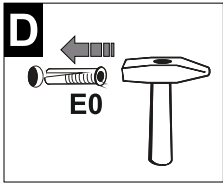
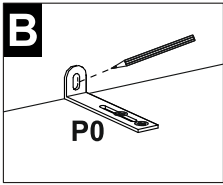
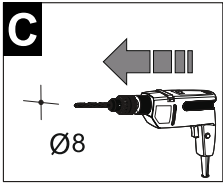
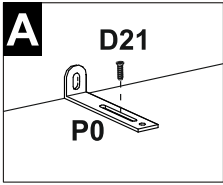

U0

x4

