

A

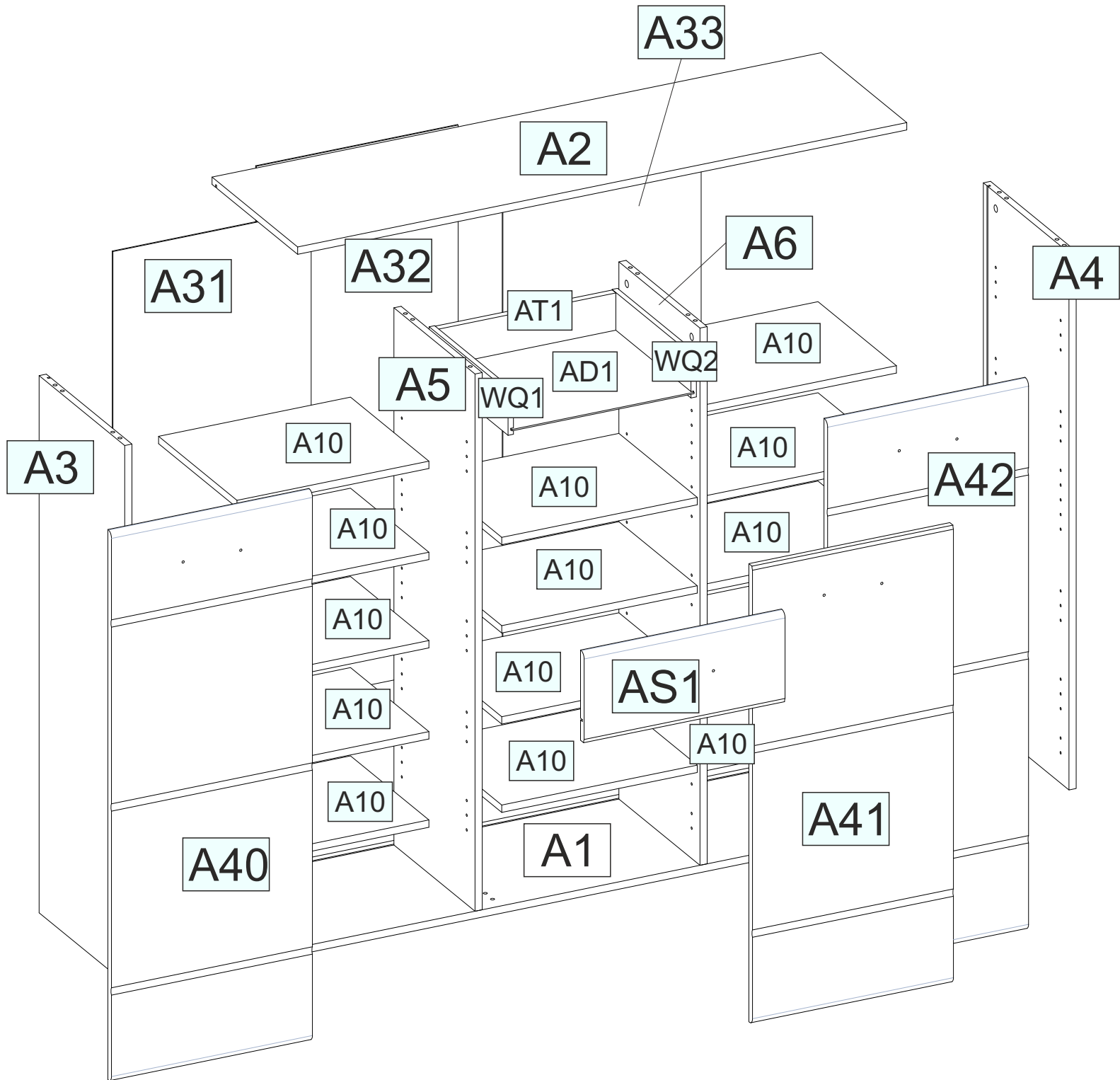

1

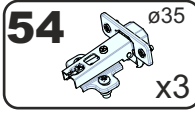
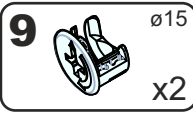
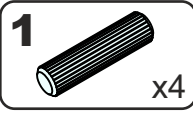

A3 1168x380



Colli nr 1

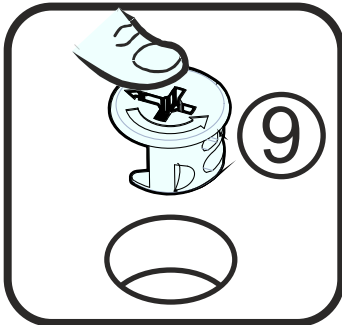
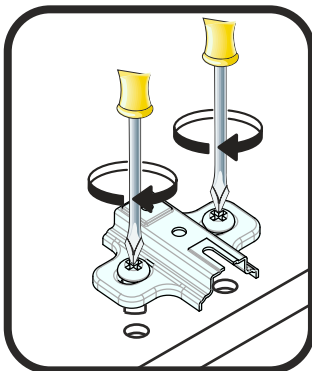
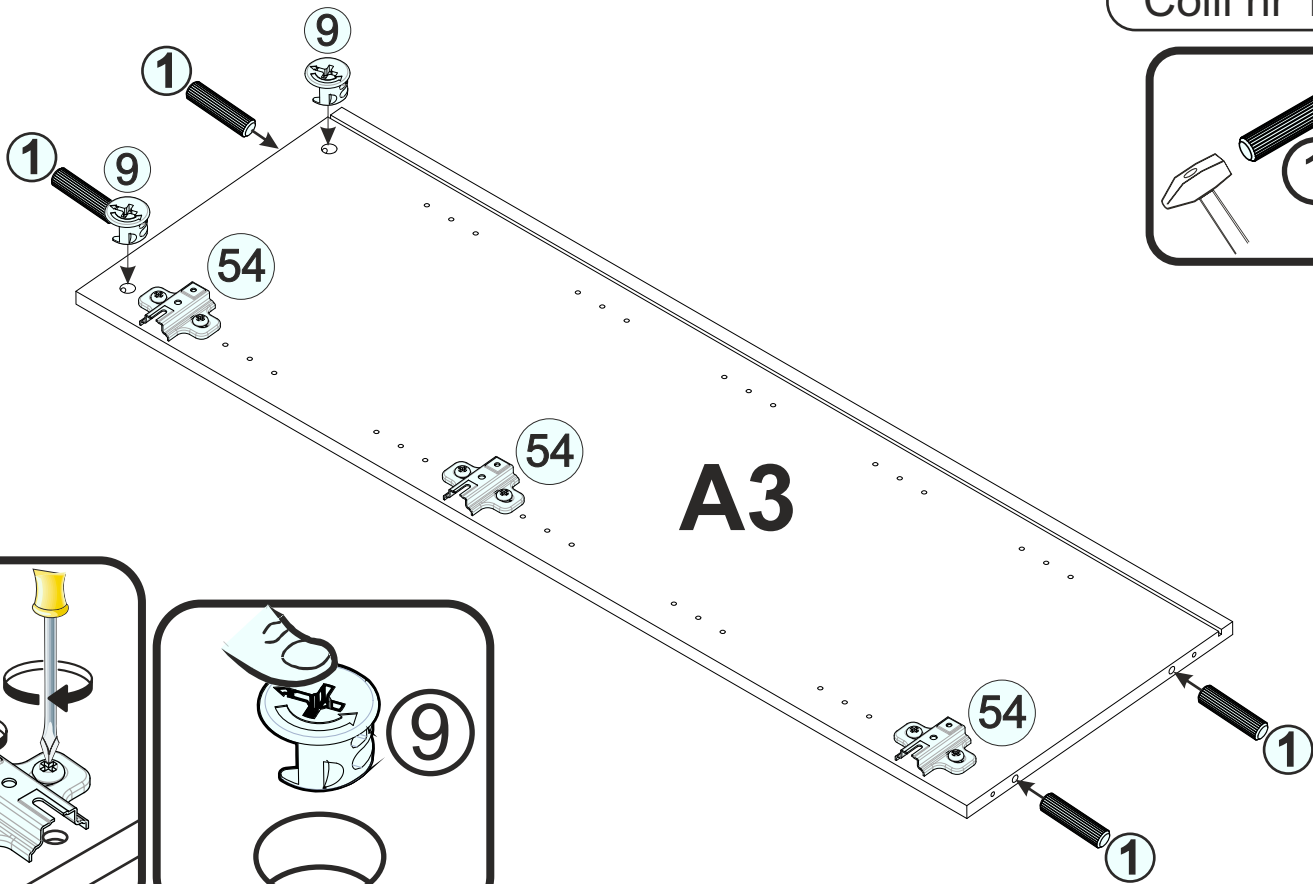
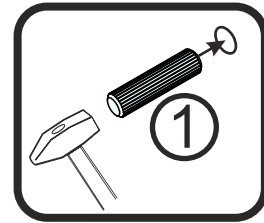

2

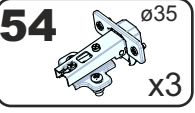
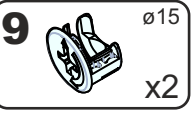
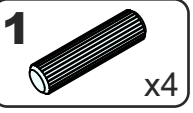

A4 1168x380



Colli nr 1

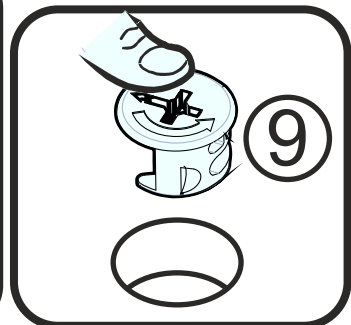
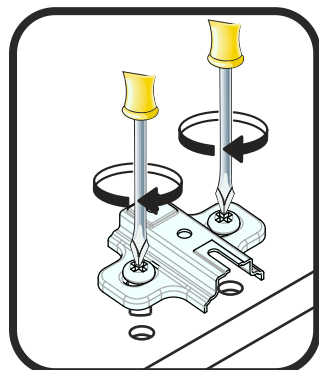
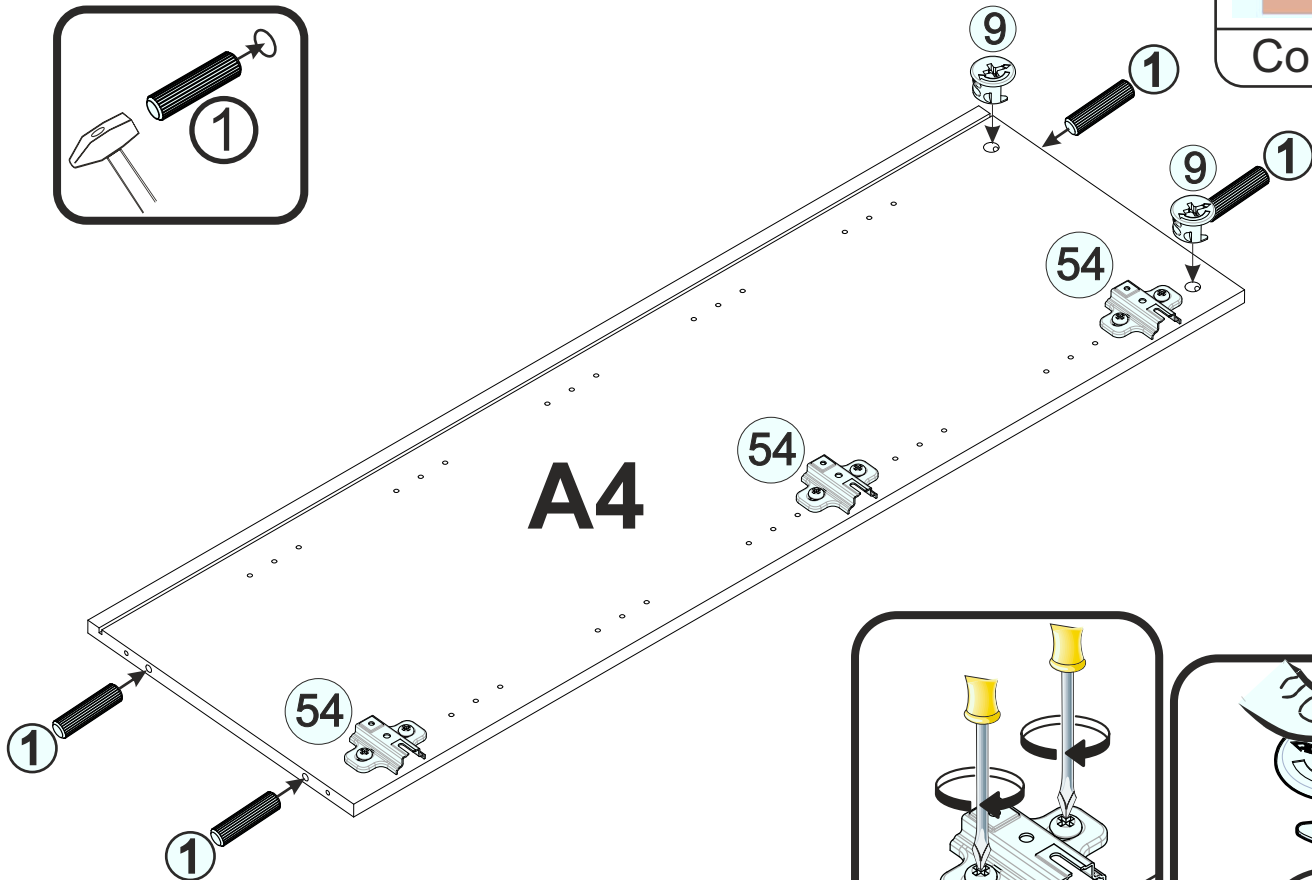
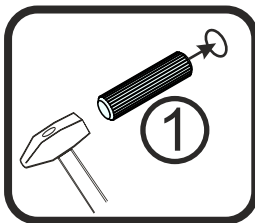

3

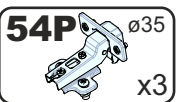
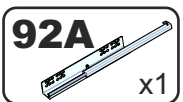
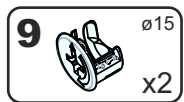
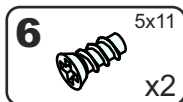
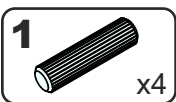

A5 1168x360

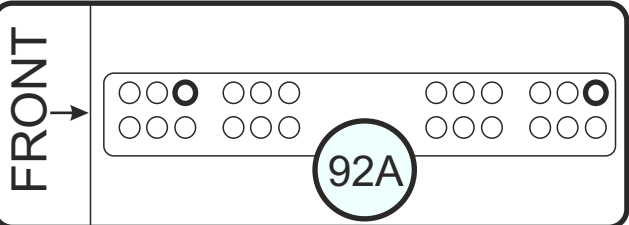
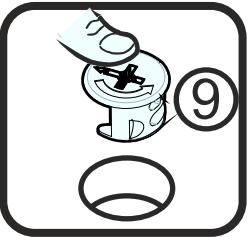
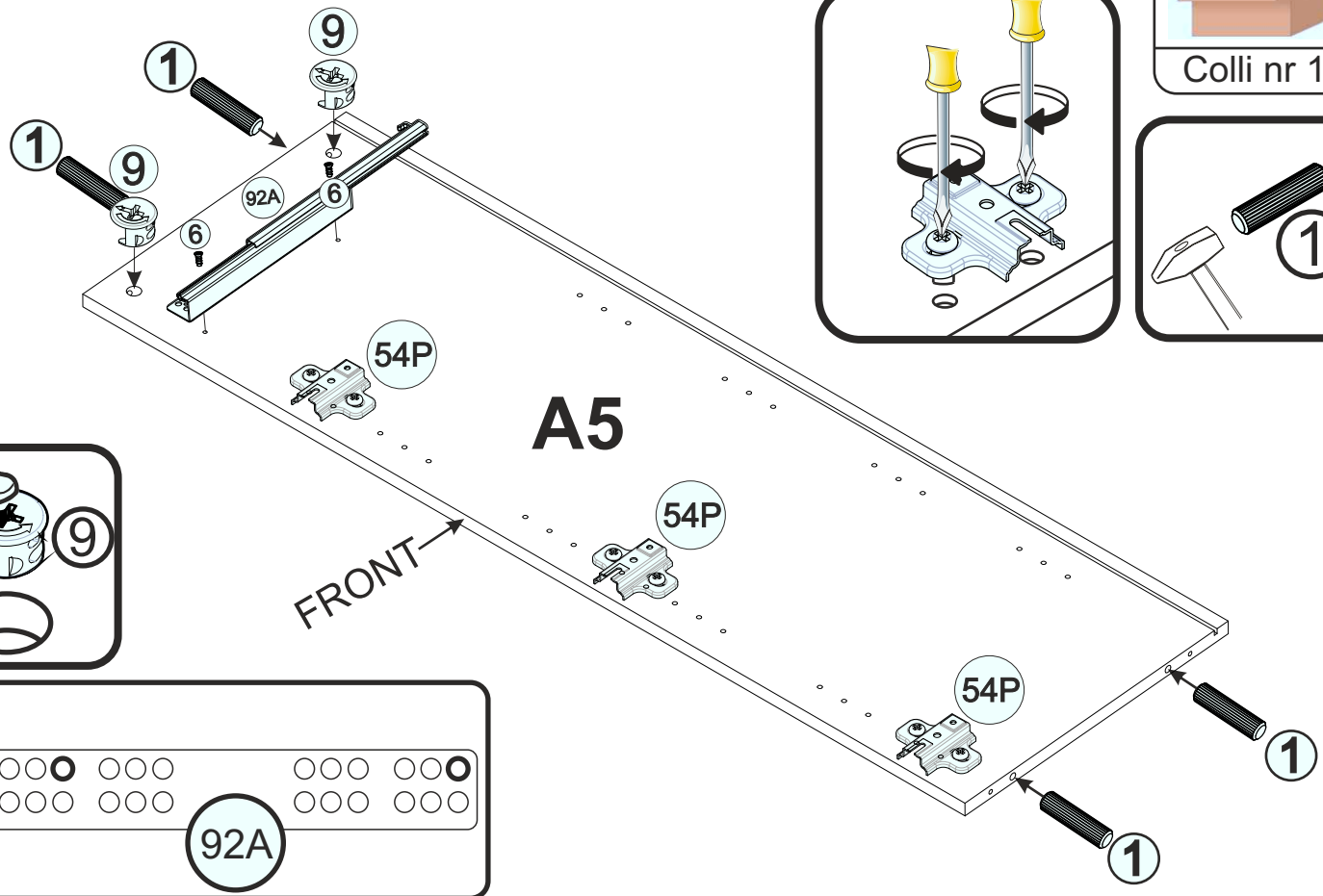
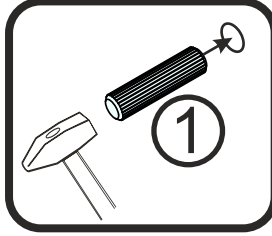
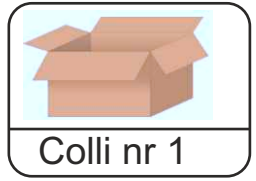

4

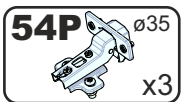
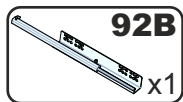
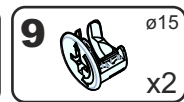
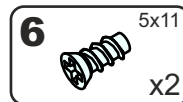
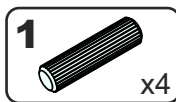

A6 1168x360

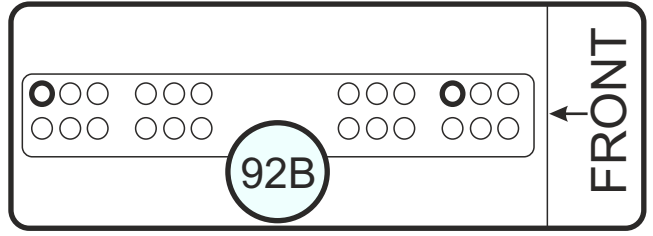
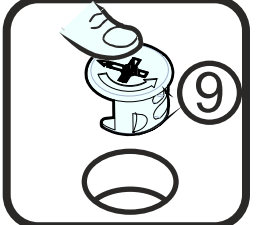
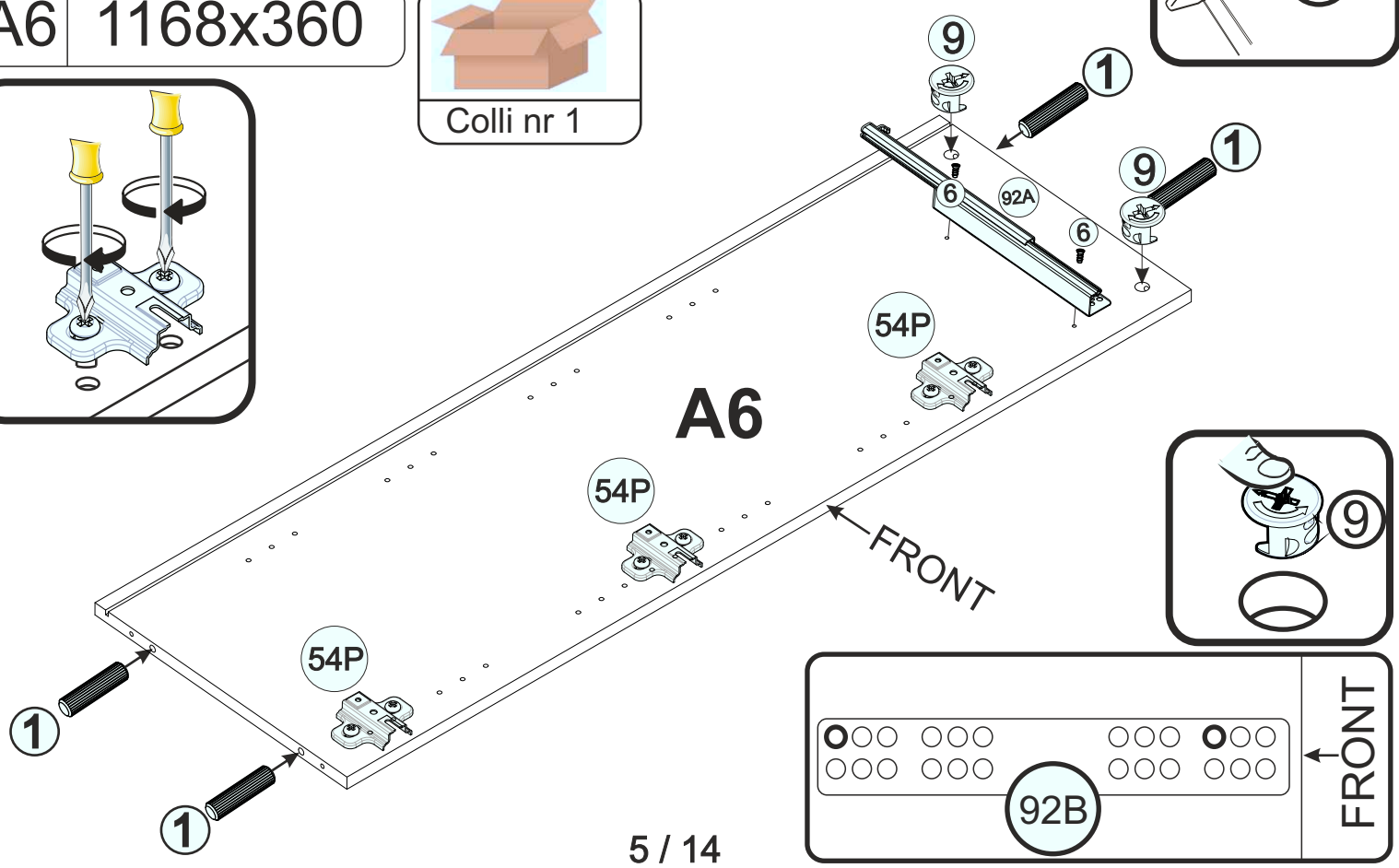
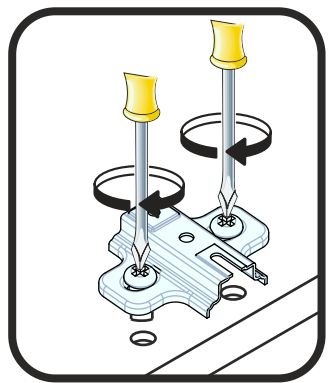
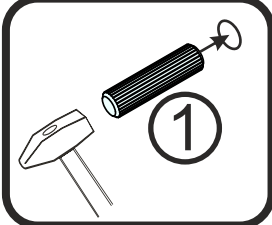
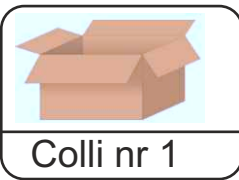

5

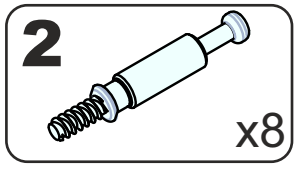

A2 1352x380

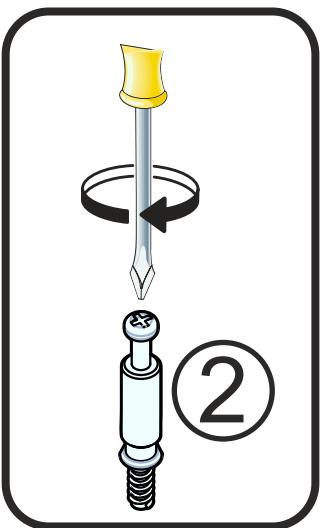
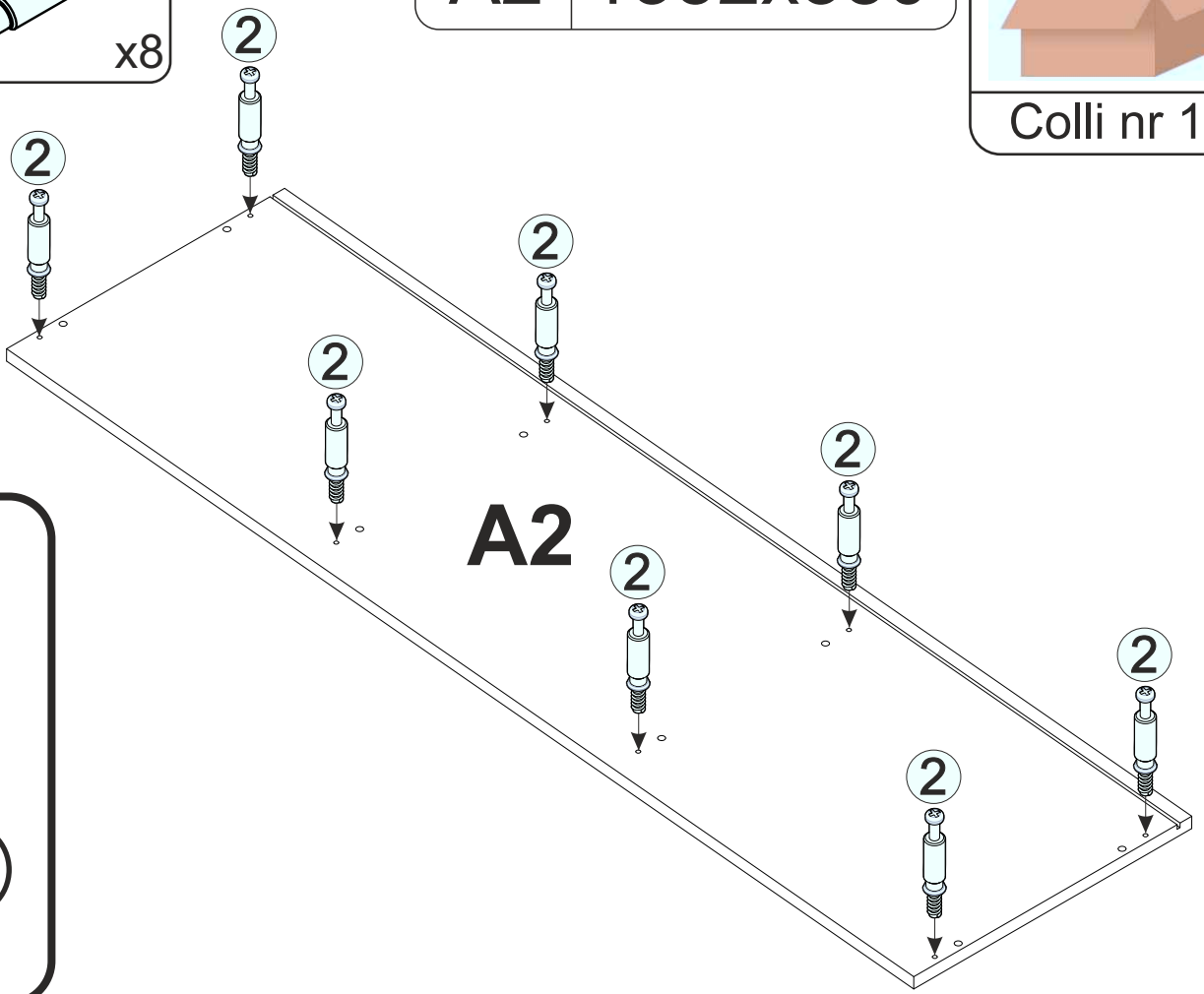
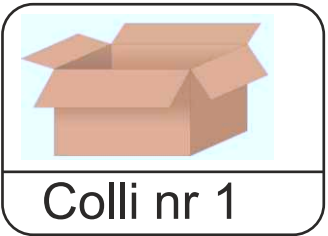

6

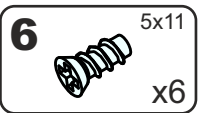
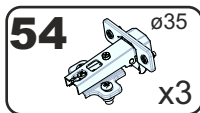

A40 1196x446

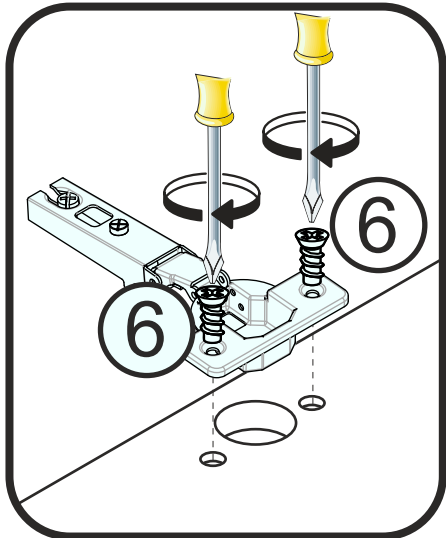
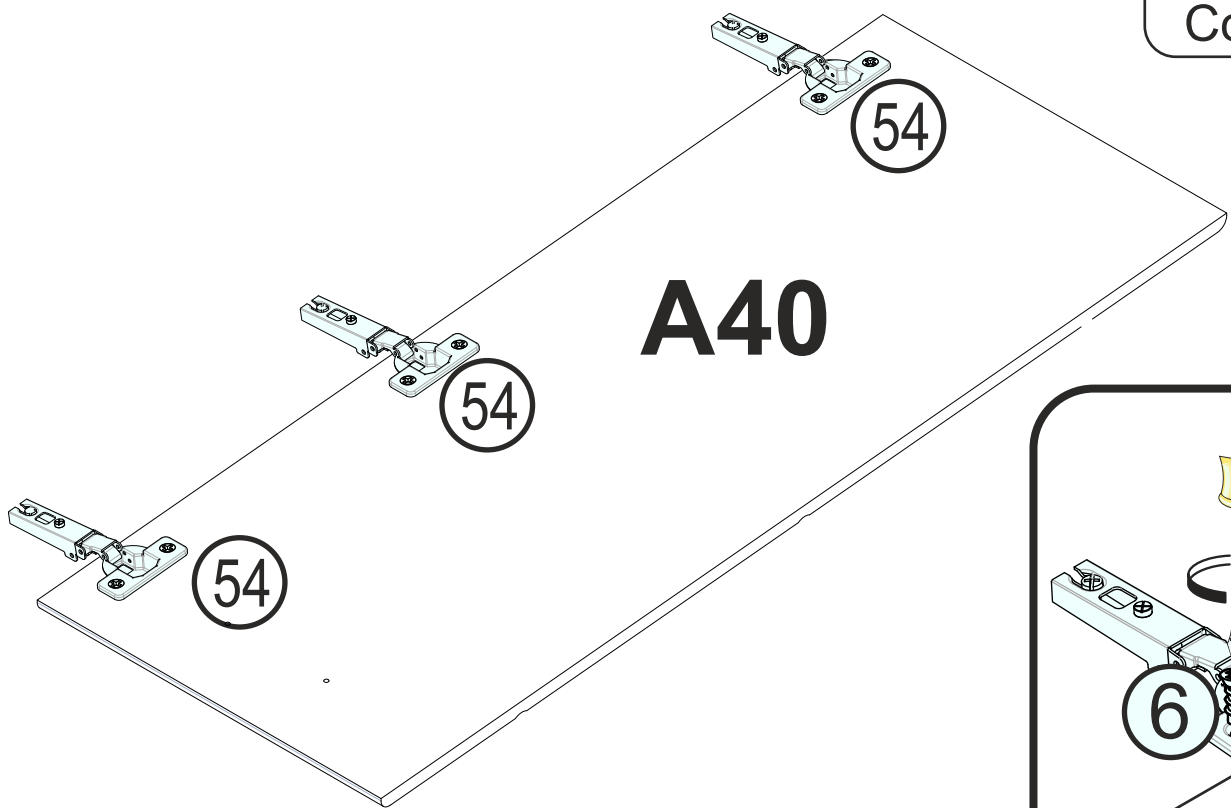
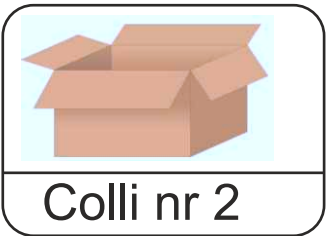

7

54

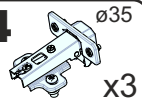

6

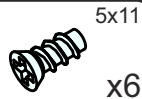

A42 1196x446

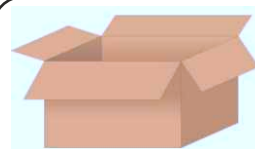

Colli nr 2

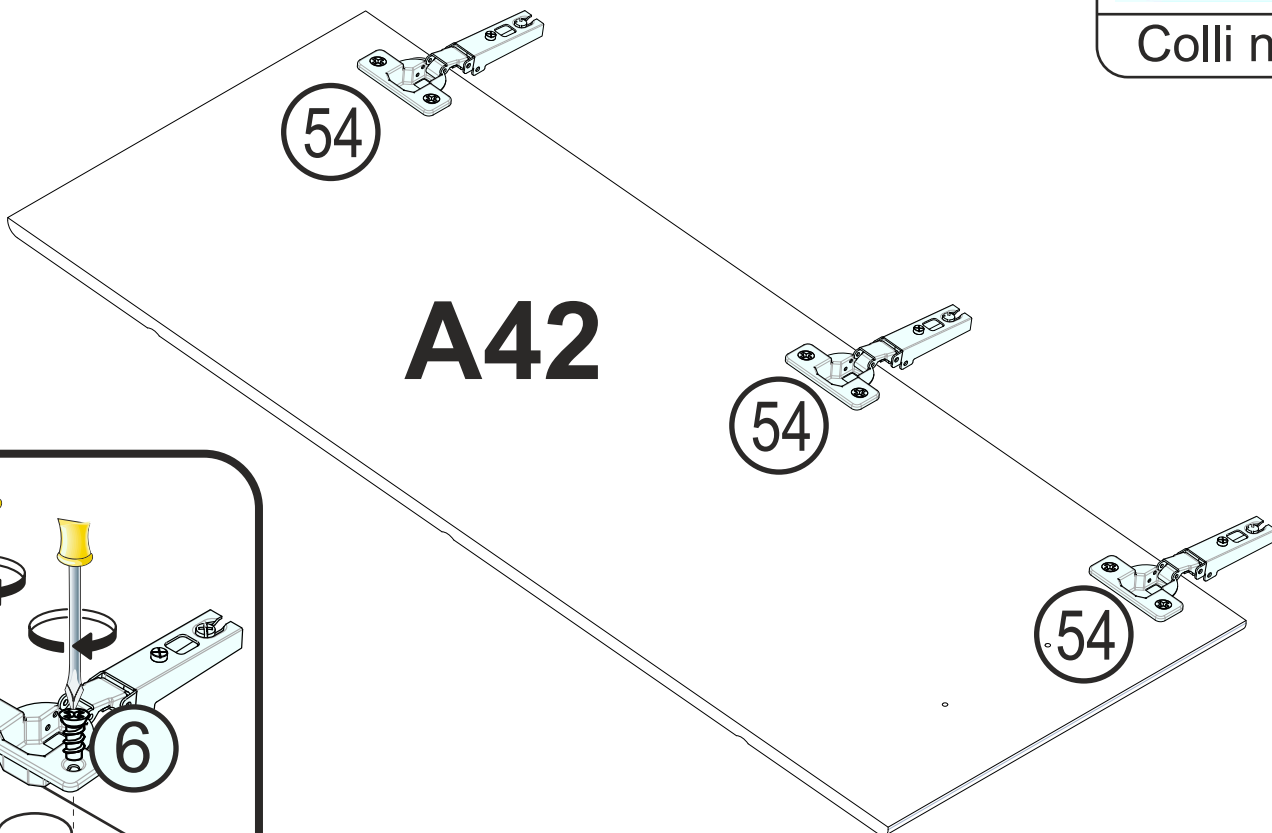

A42

54

54

54

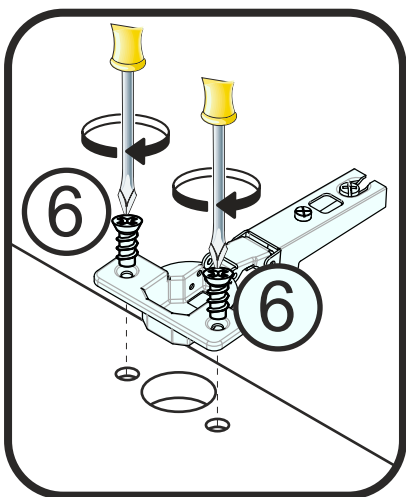

6

6

8

54P

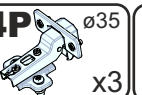

6

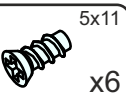

A41 996x446



Colli nr 2

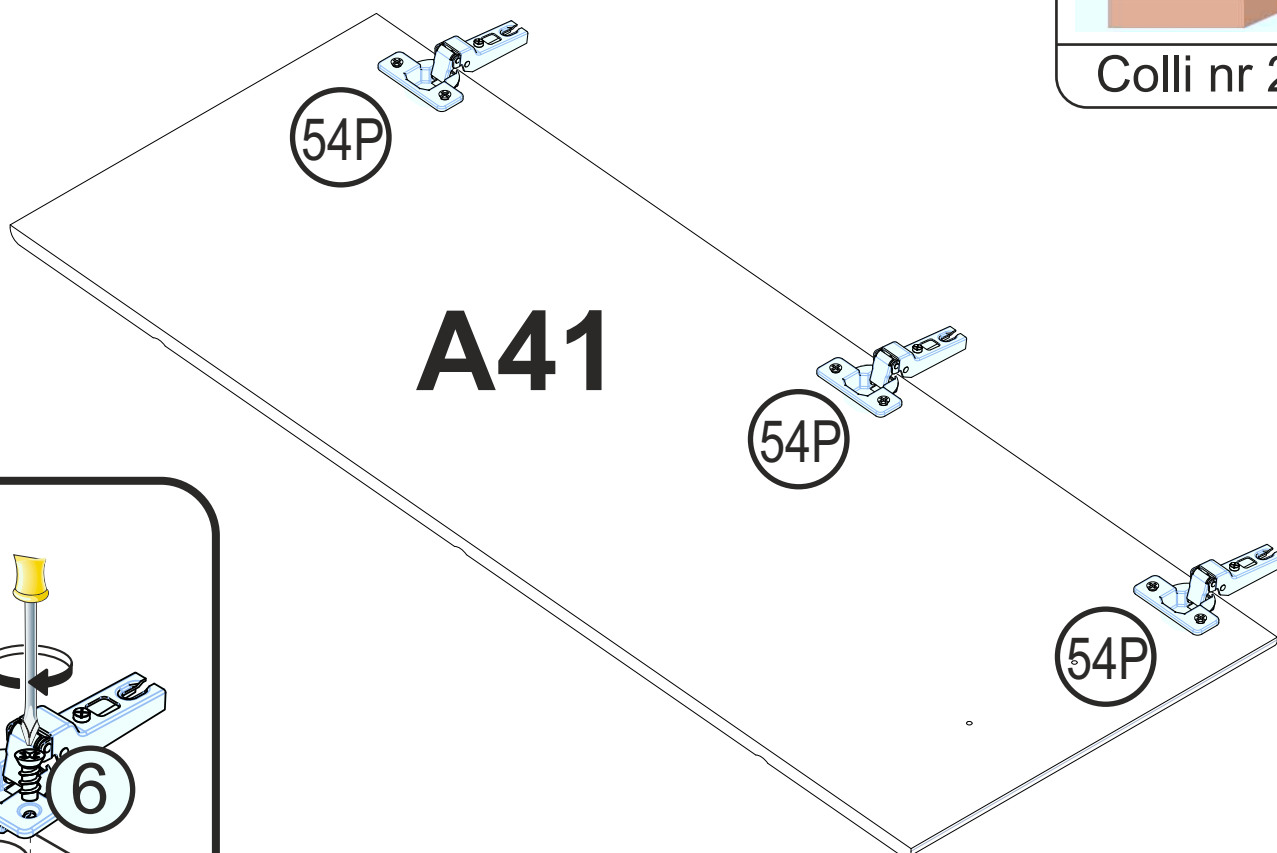

A41

54P

54P

54P

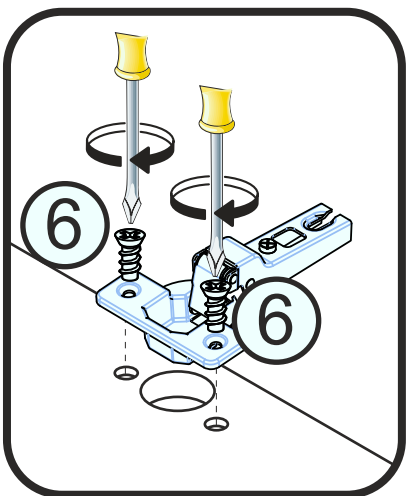

6

6

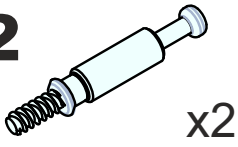
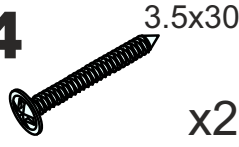
9**2****3****4**

AS1 446x196

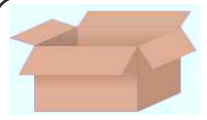

Colli nr 2

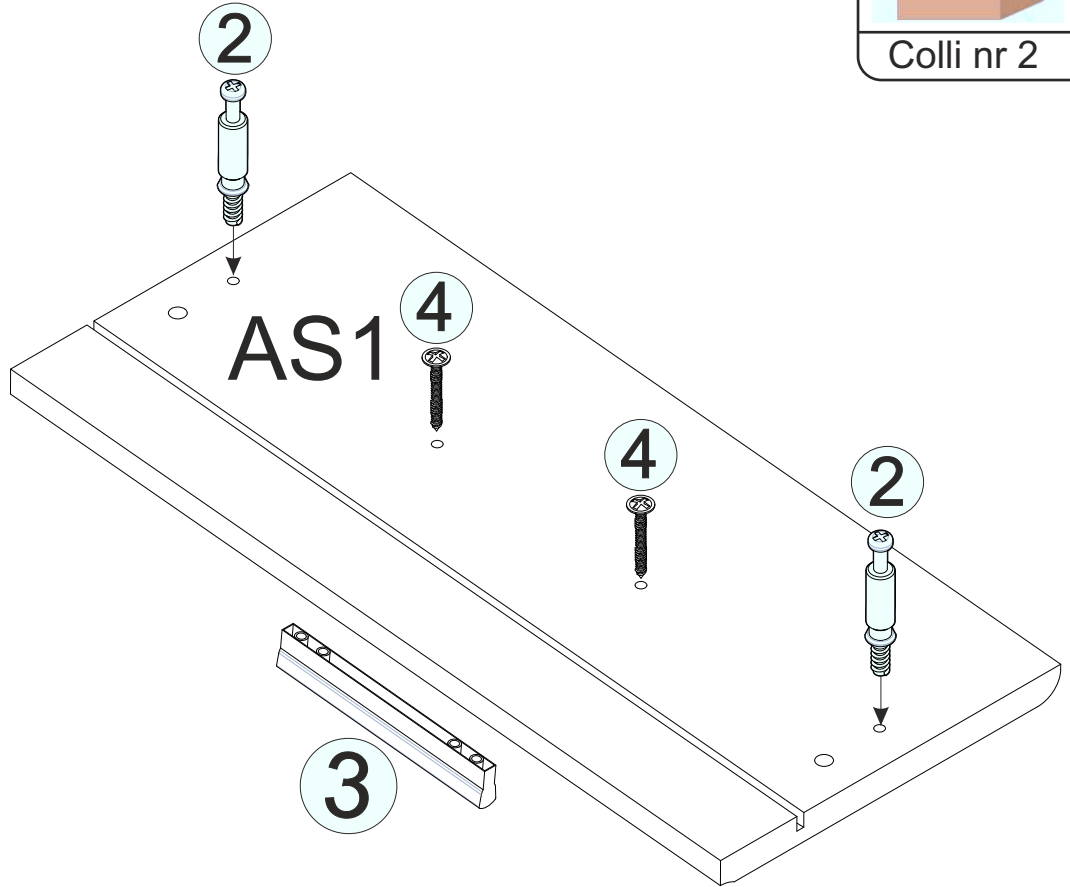
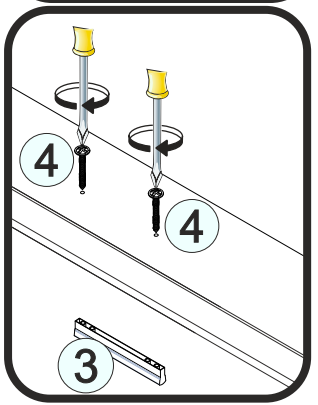
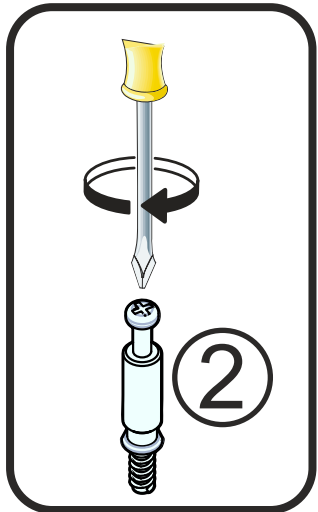
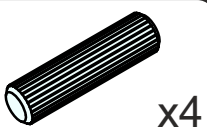
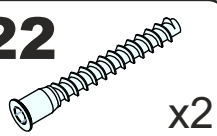
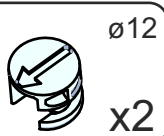
**10****1****22****24**

AT1 394x82

WQ1 350x96

WQ2 350x96

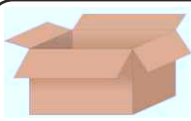
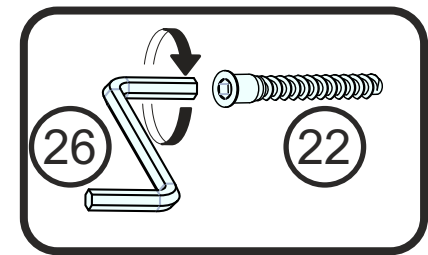

Colli nr 3

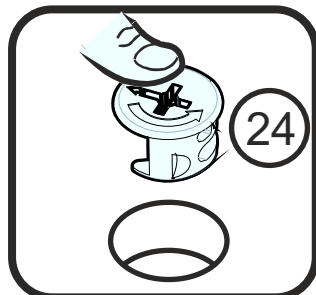
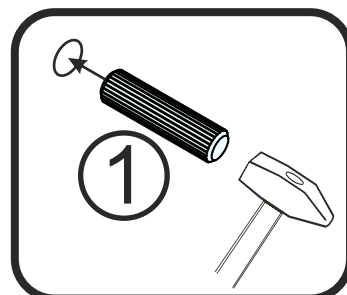
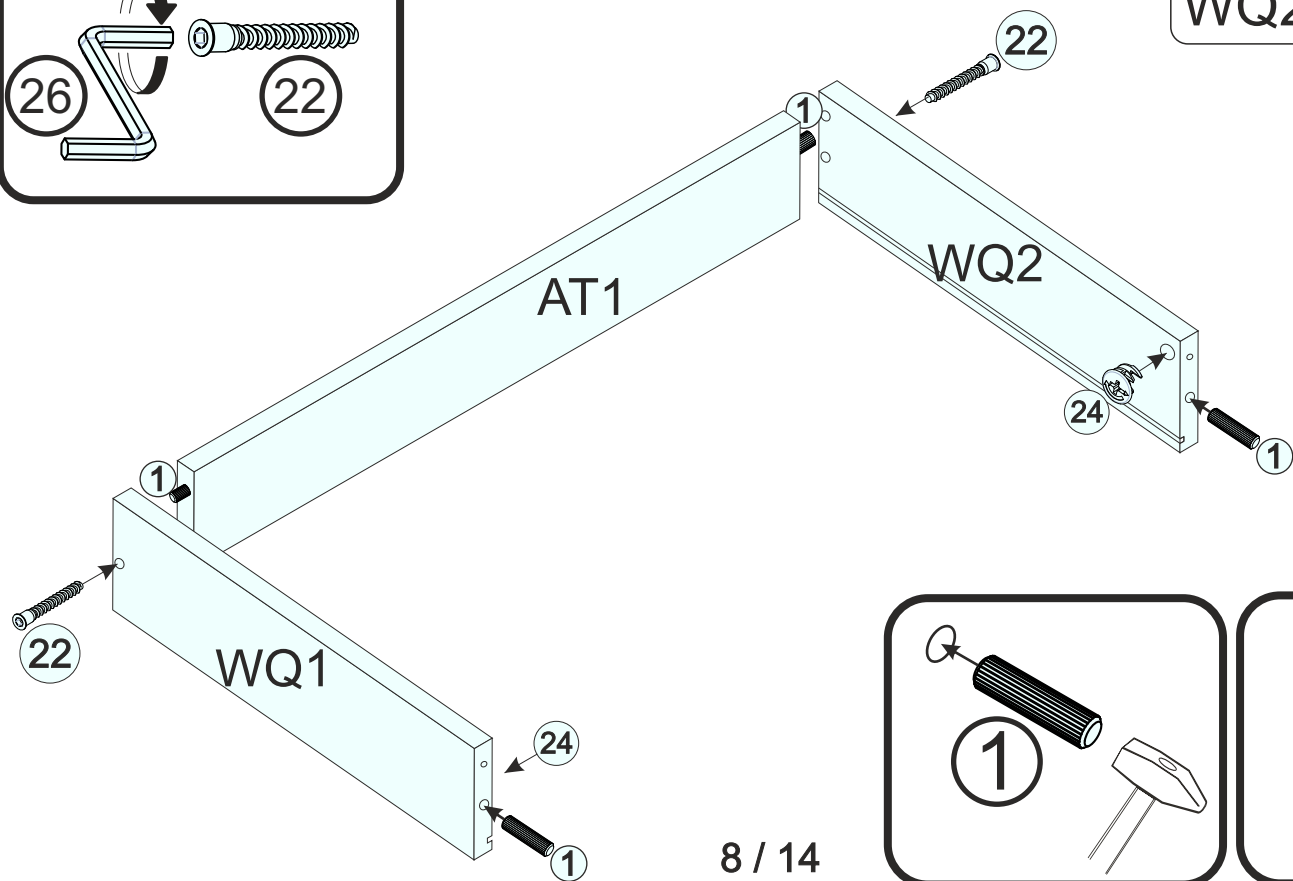

11

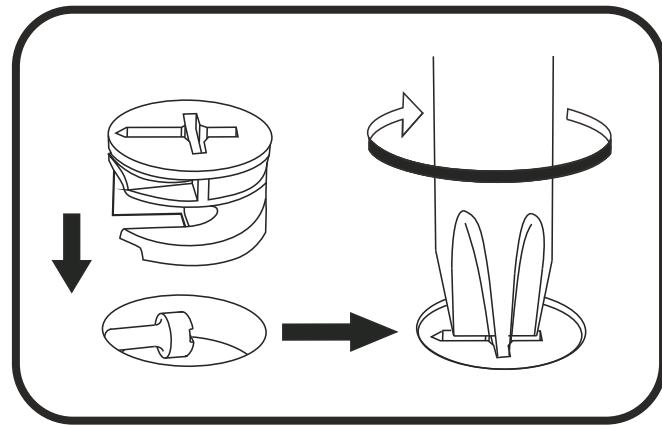
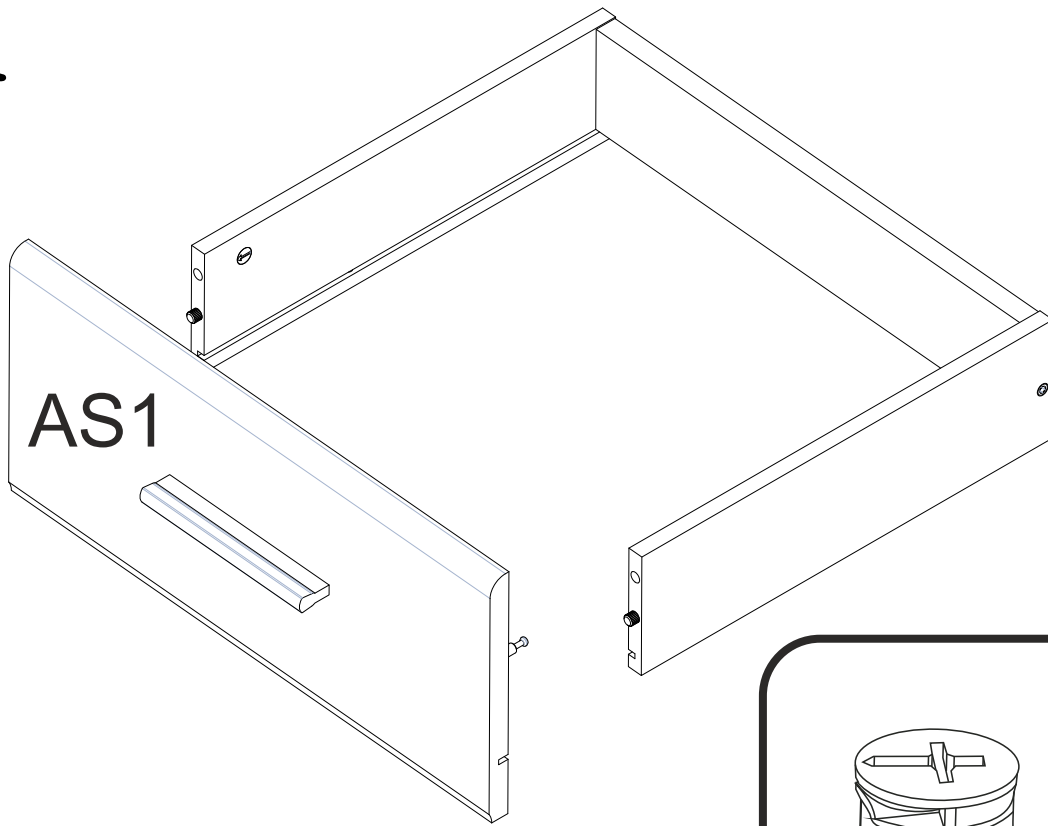

12

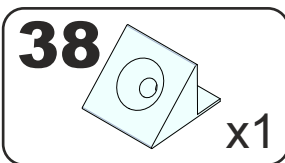
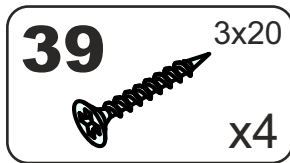

AD1 404x353

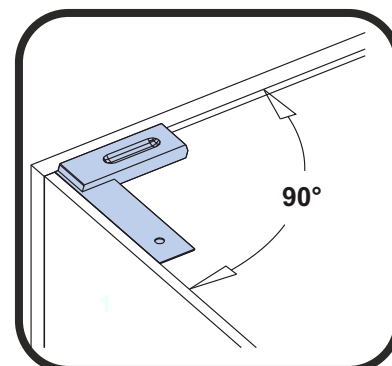
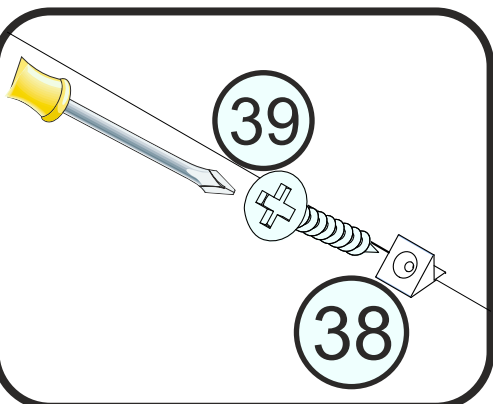
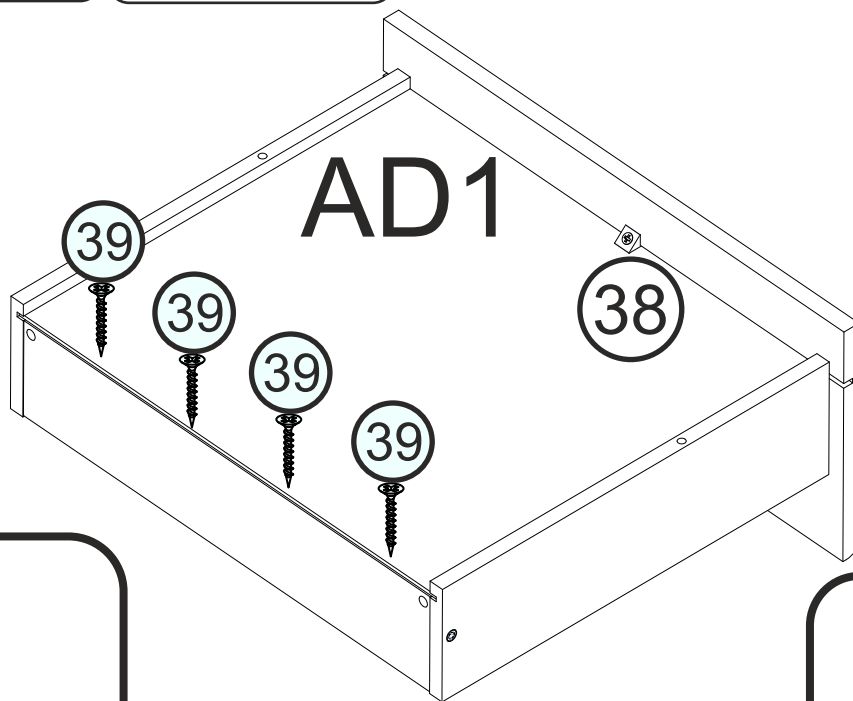
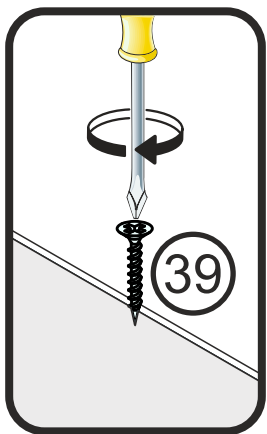
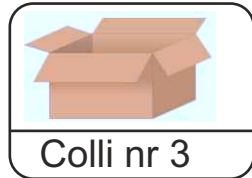

13

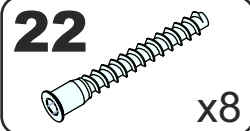

A1 1352x380

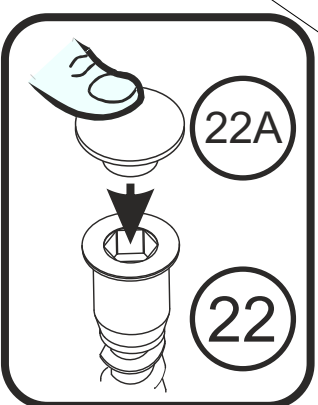
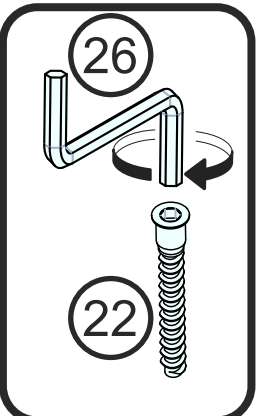
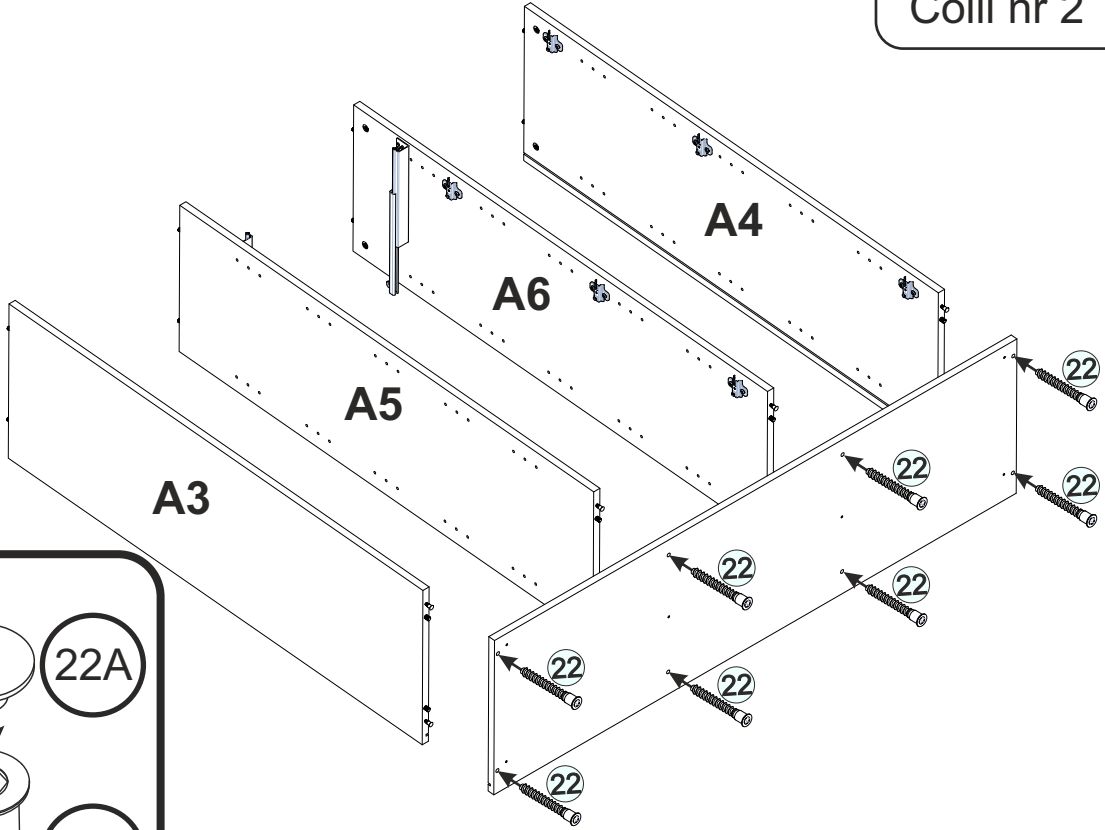
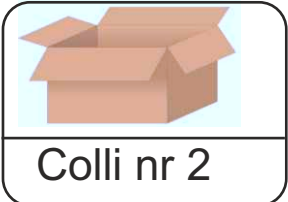

14

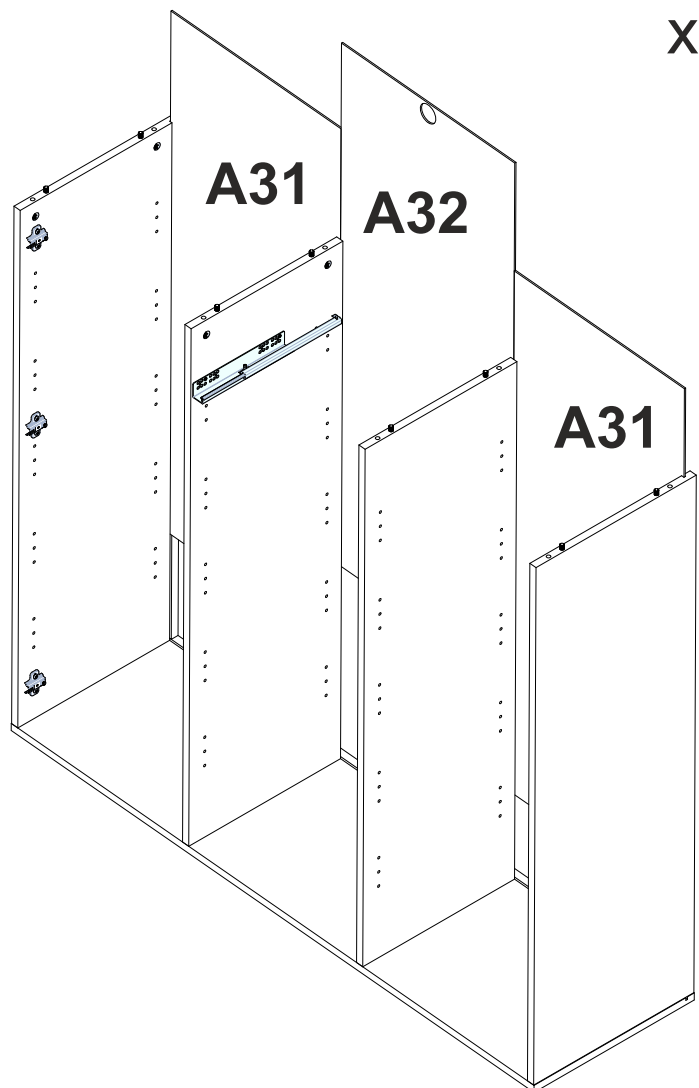

x2 A31 1178x440

A32 1178x448

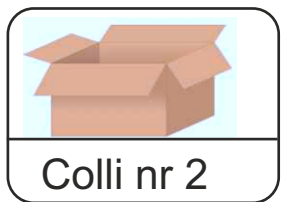

15

9A



x8

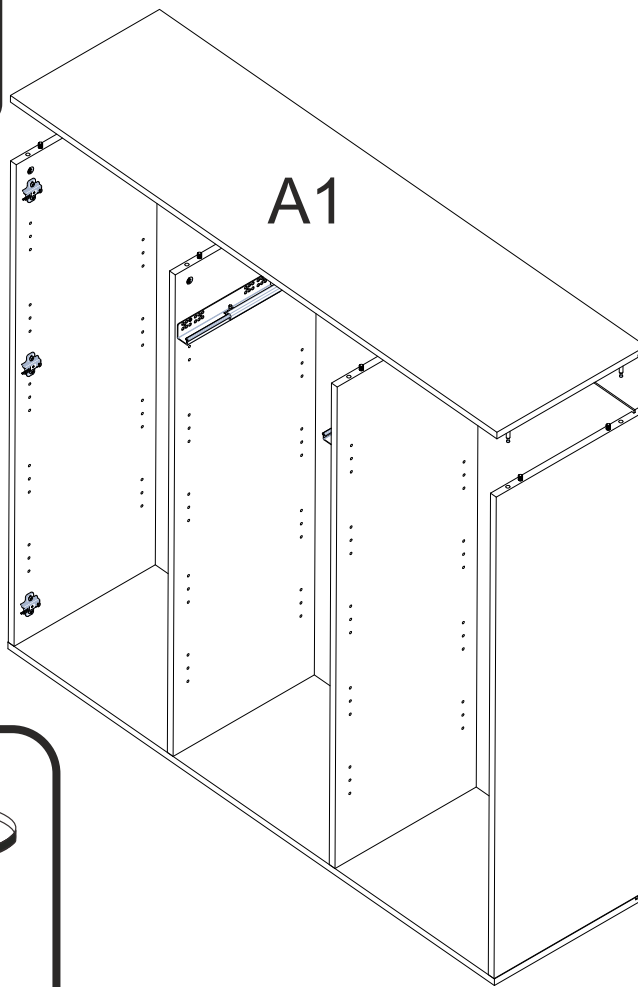

A1

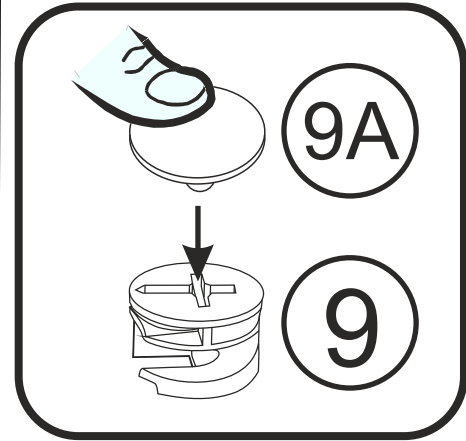

9A

9

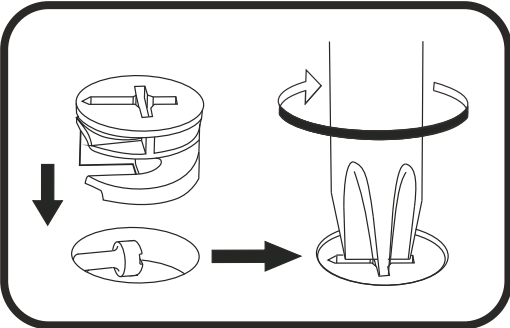

16

38

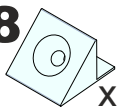

x18

39



3x20
x18

35

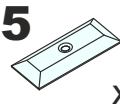

x22

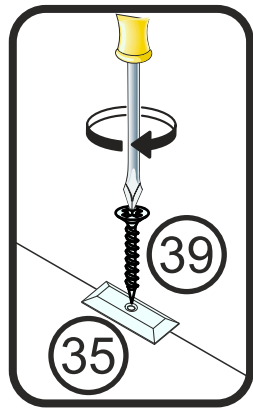
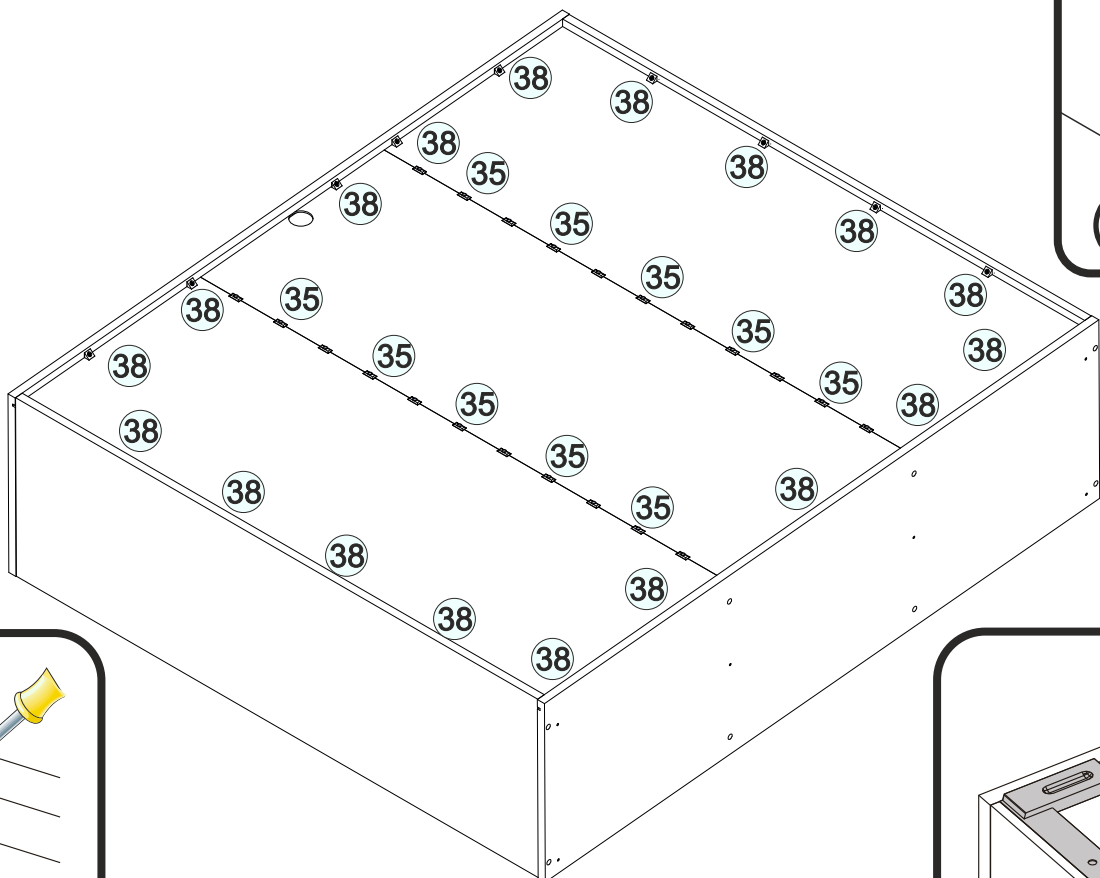

39

35

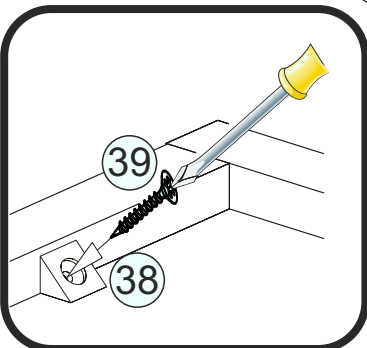

39

38

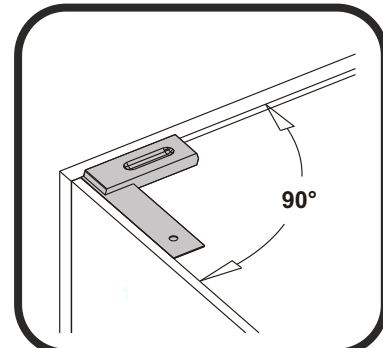

90°

17

10



x6

4A

4x16



x6

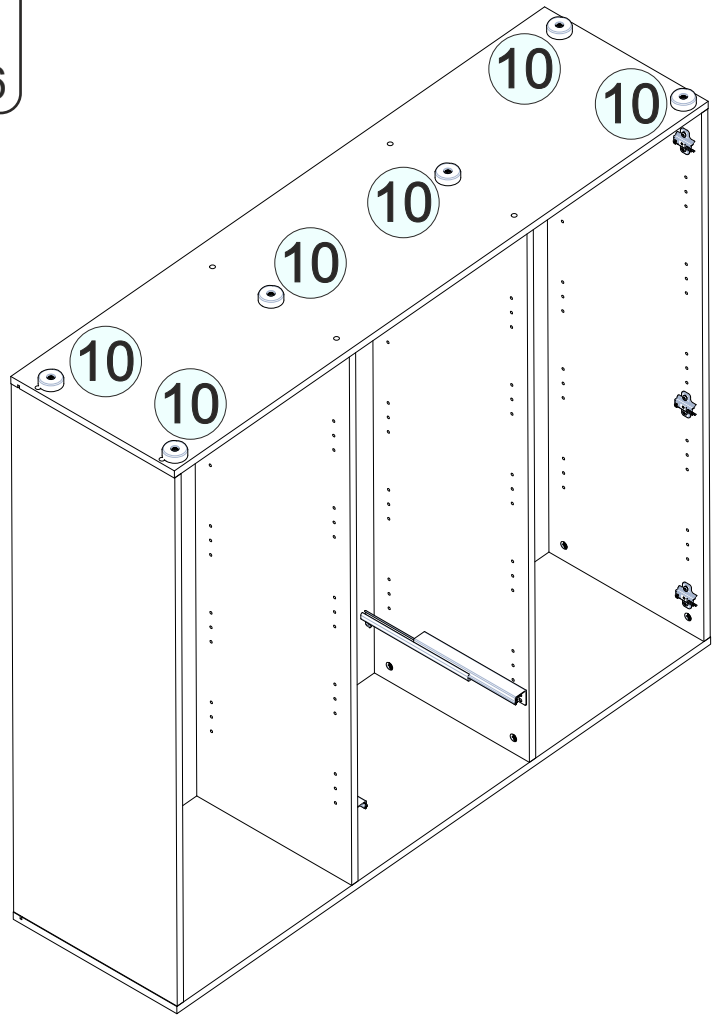
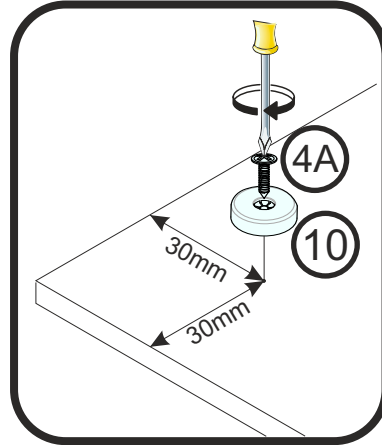
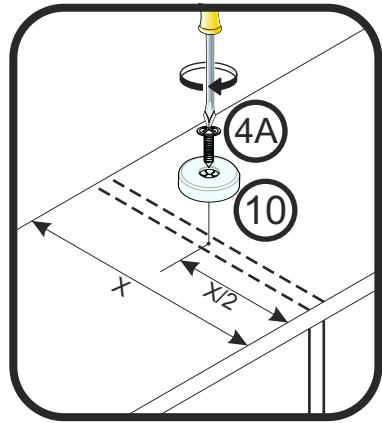

18

4A

4x16



x1

41

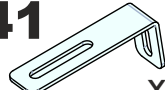

x1

80

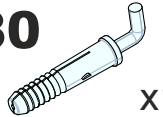

x1

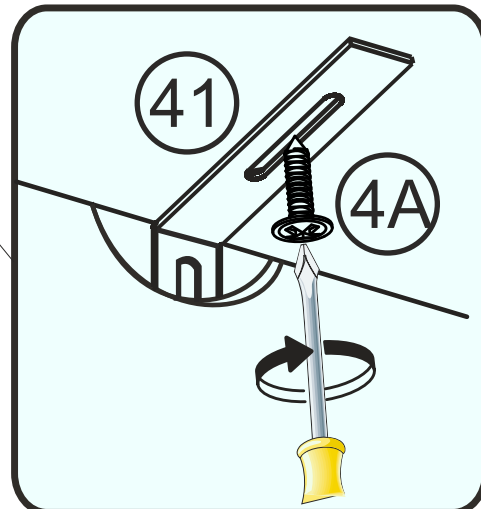
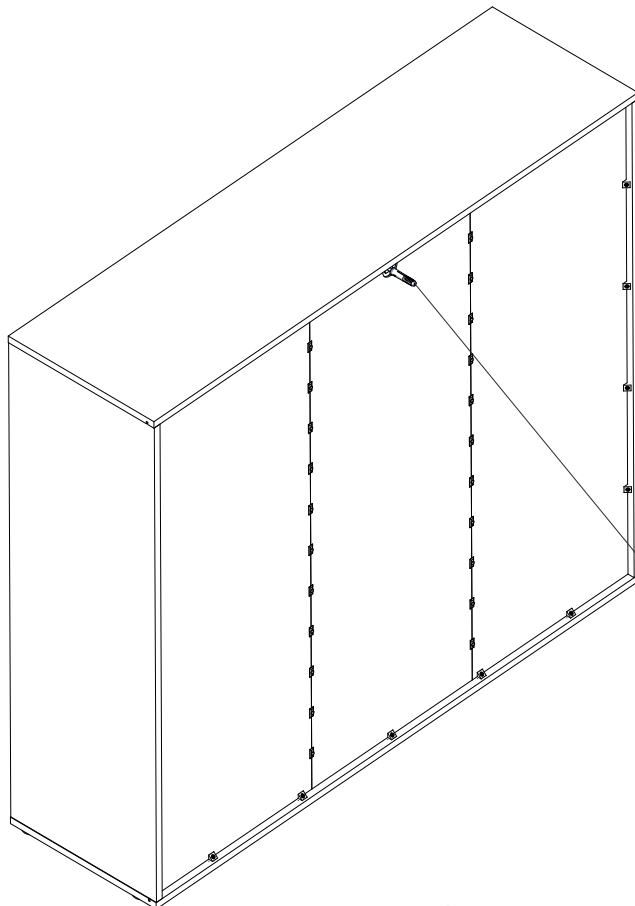
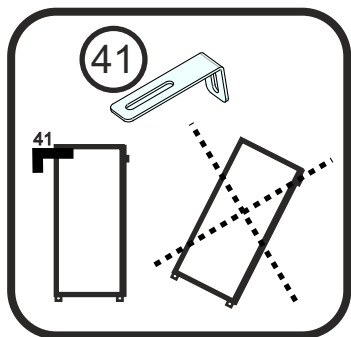
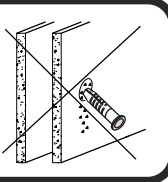
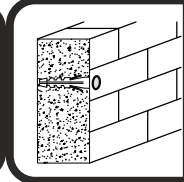
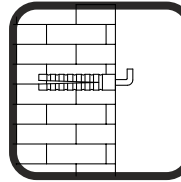

19

13

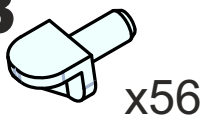

A10	426x348	x10
-----	---------	-----

A11	434x348	x4
-----	---------	----

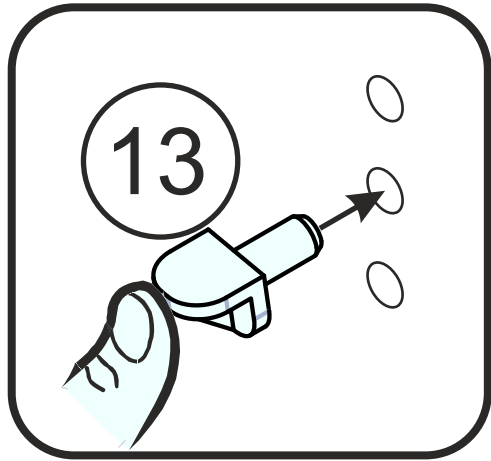
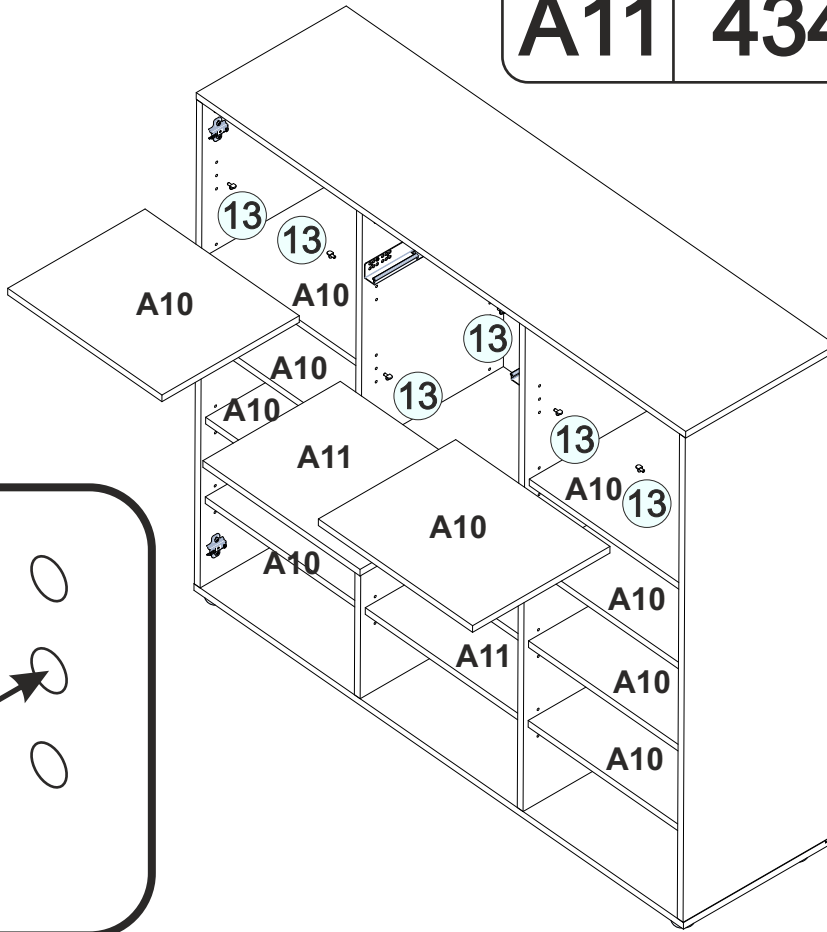
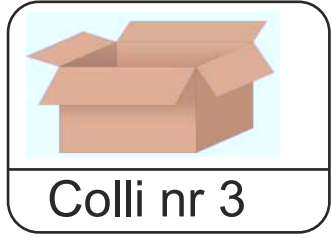

20

3

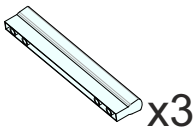

4

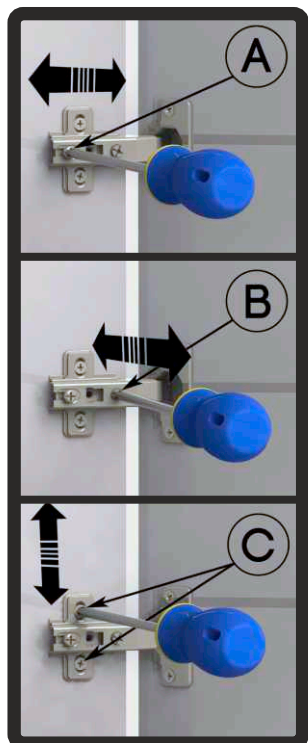
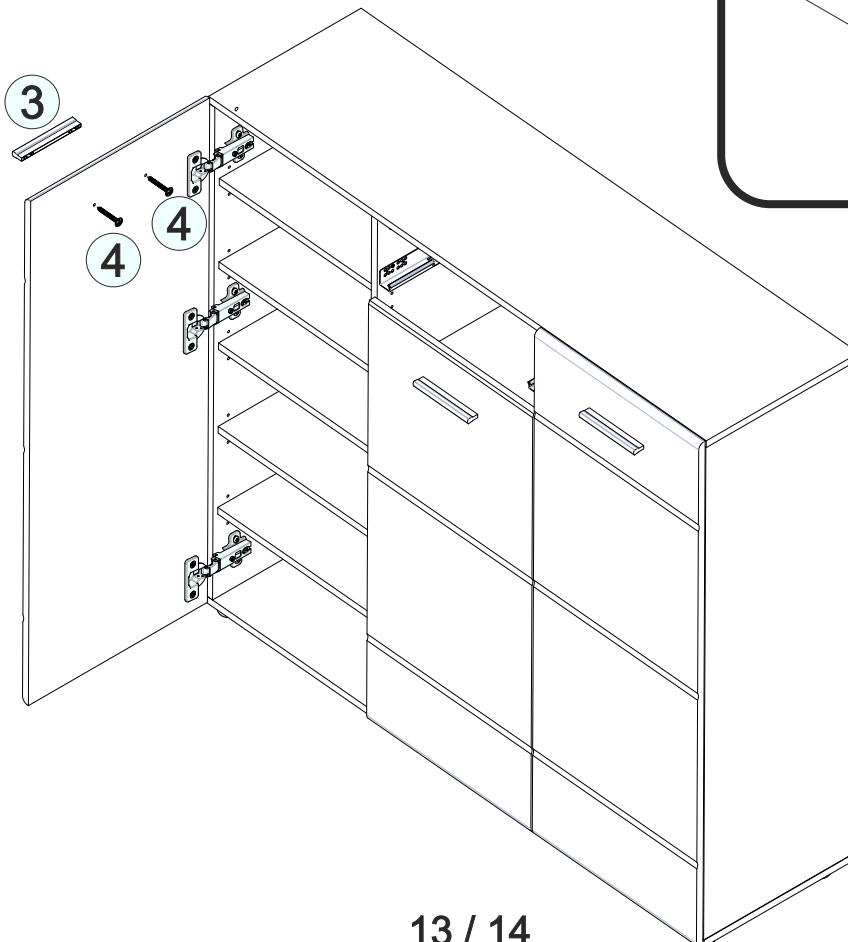
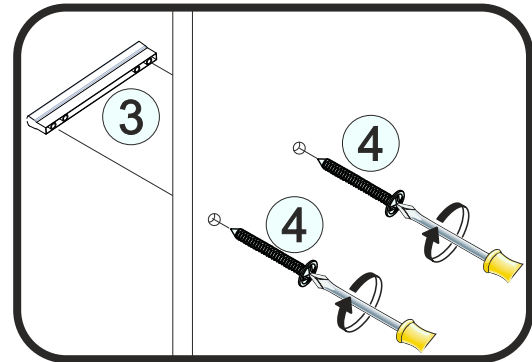
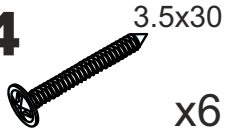

21

