



















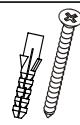

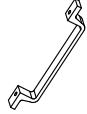

A0	B0	B1	B2	C0	C2	C7	D0	D5	D13	D21
										
ø8x30	ø 7mm	ø7x50	ø7x70	ø16mm		16mm	3x15	3,5x16	4x30	5x13
x18	x10	x10	x4	x9	x9	x9	x20	x20	x2	x15

E0	H2	J4	J6	K	L42	M1	N7	P0	Q3	Q4
										
8x50	4x22			4mm			L-350			
x1	x6	x4	x4	x1	x3	x20	x1	x1	x8	x2

T8	T25	U0
		
x10	x2	x4

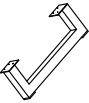

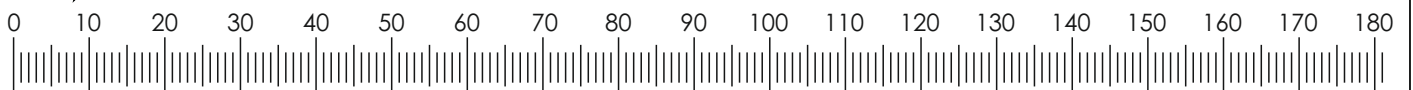
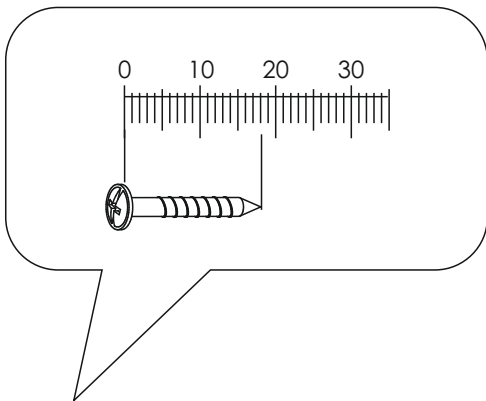





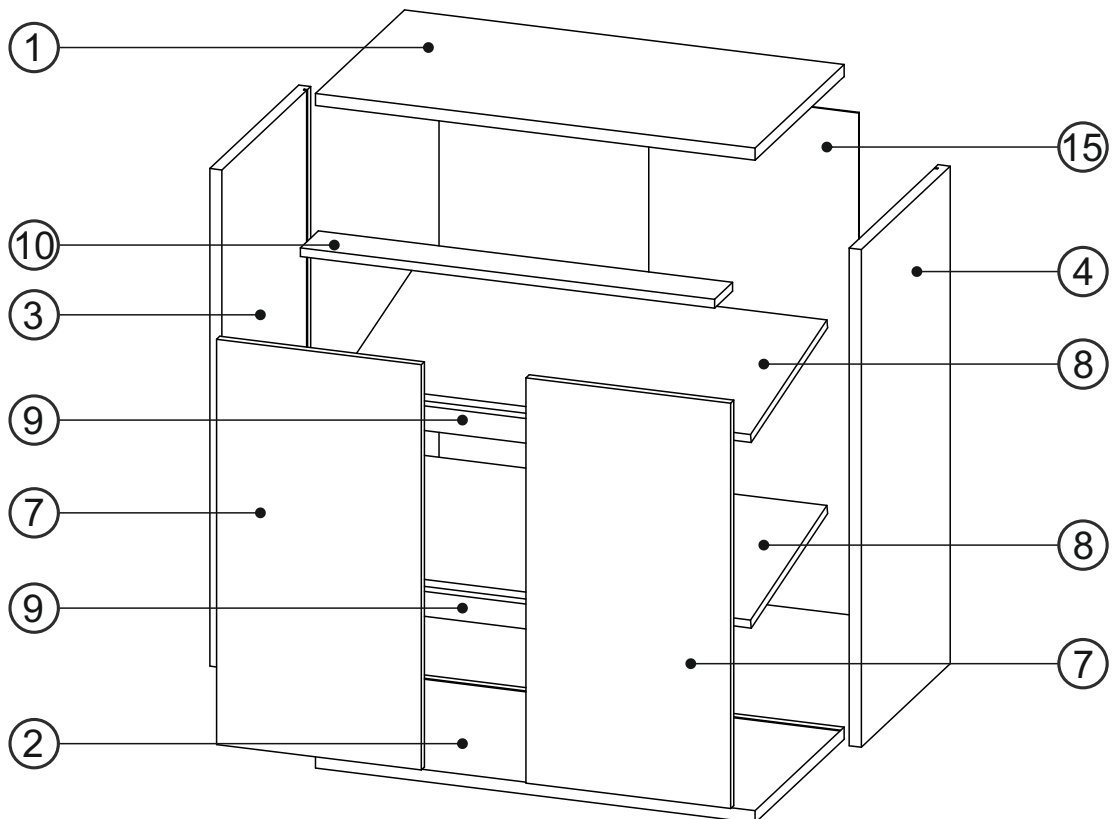
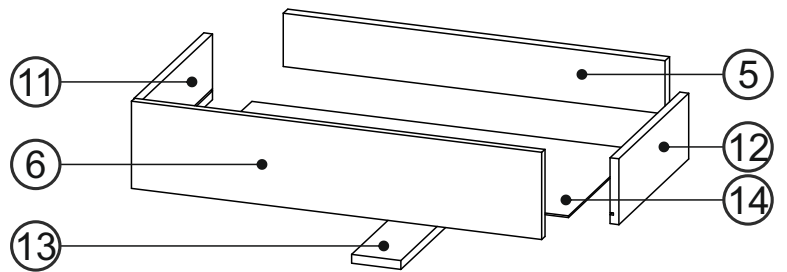

①	800	445	22	x1	1/3
②	800	445	22	x1	1/3
③	906	444	22	x1	1/3
④	906	444	22	x1	1/3
⑤	696	97	22	x1	2/3
⑥	748	159	16	x1	2/3
⑦	738	372,5	16	x2	2/3
⑧	753	390	16	x2	2/3
⑨	753	50	16	x2	2/3
⑩	754	90	16	x1	2/3
⑪	350	120	16	x1	2/3
⑫	350	120	16	x1	2/3
⑬	349	90	16	x1	2/3
⑭	764	916	3	x1	1/3
⑮	706	354	3	x1	1/3



					3/3
--	--	--	--	--	-----

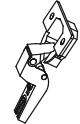

1

A0  ∅8x30 x8	C7  16mm x4	D5  3,5x16 x8	D21  5x13 x8	H2  4x22 x4	J4  x4	J6  x4	L42  x2	N7  L-350 x2	U0  x2
--	---	---	--	---	--	---	--	--	---

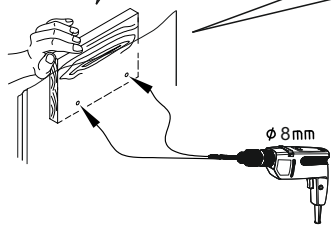
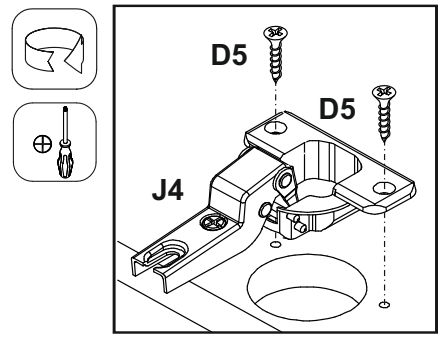
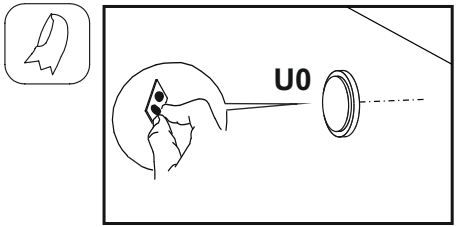
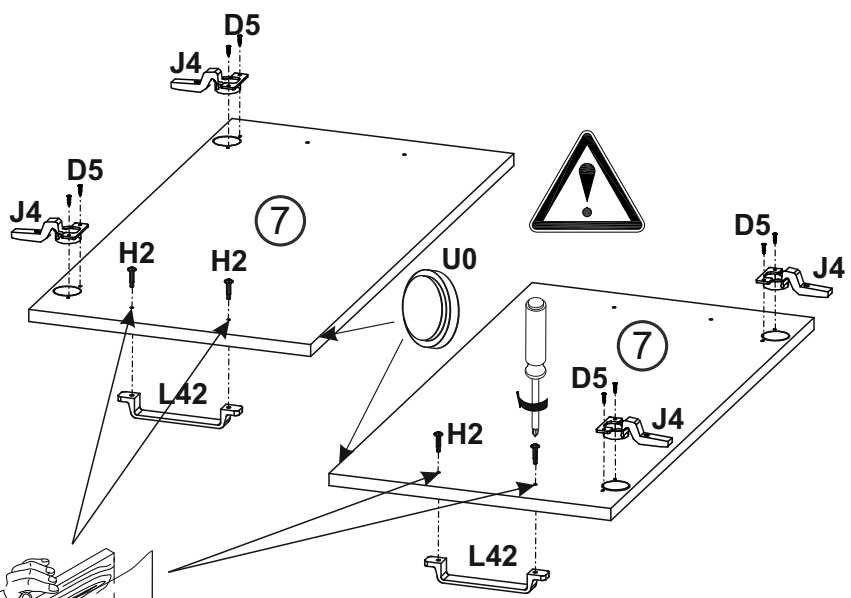
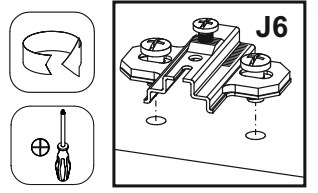
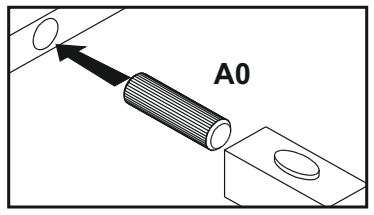
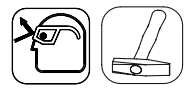
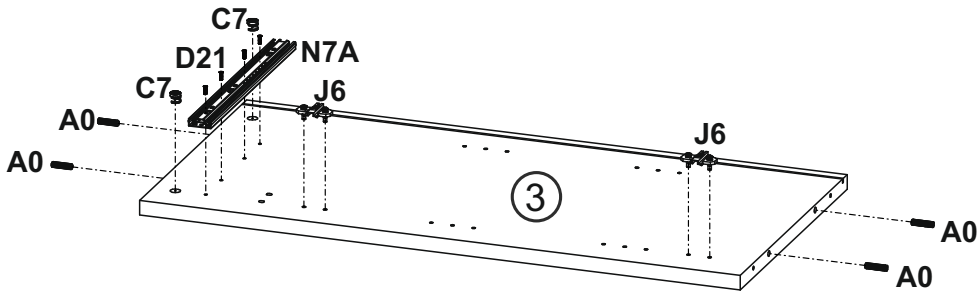
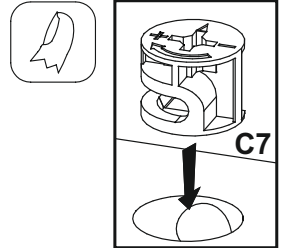
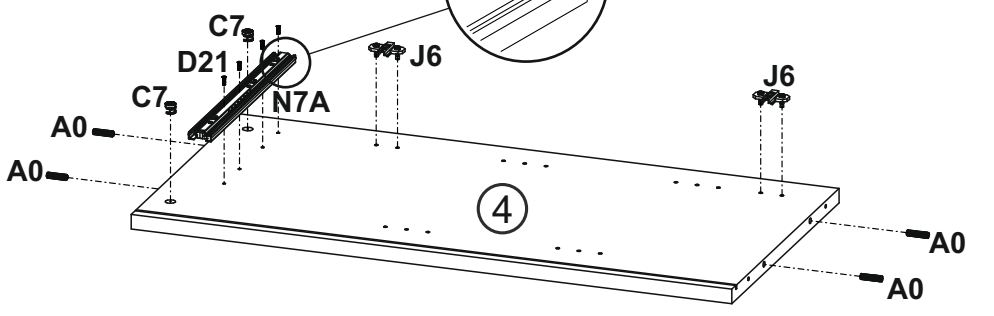
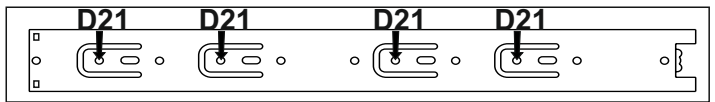
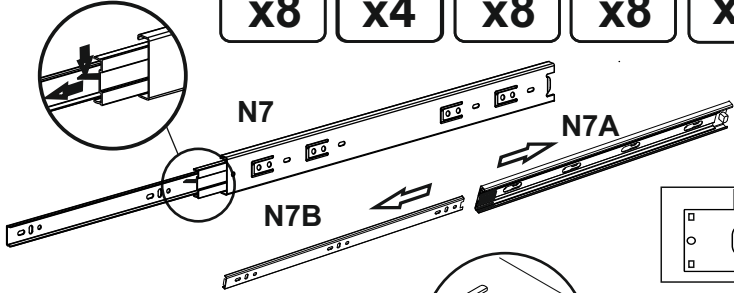

2

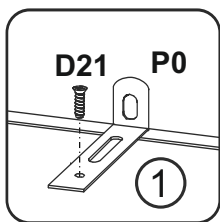
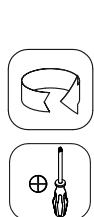
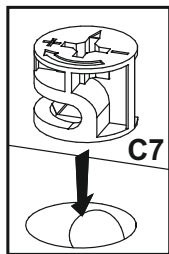

A0
∅8x30
x10

C2
16mm
x9

C7
16mm
x5

D21
5x13
x7

N7B
L-350
x2

P0
x1

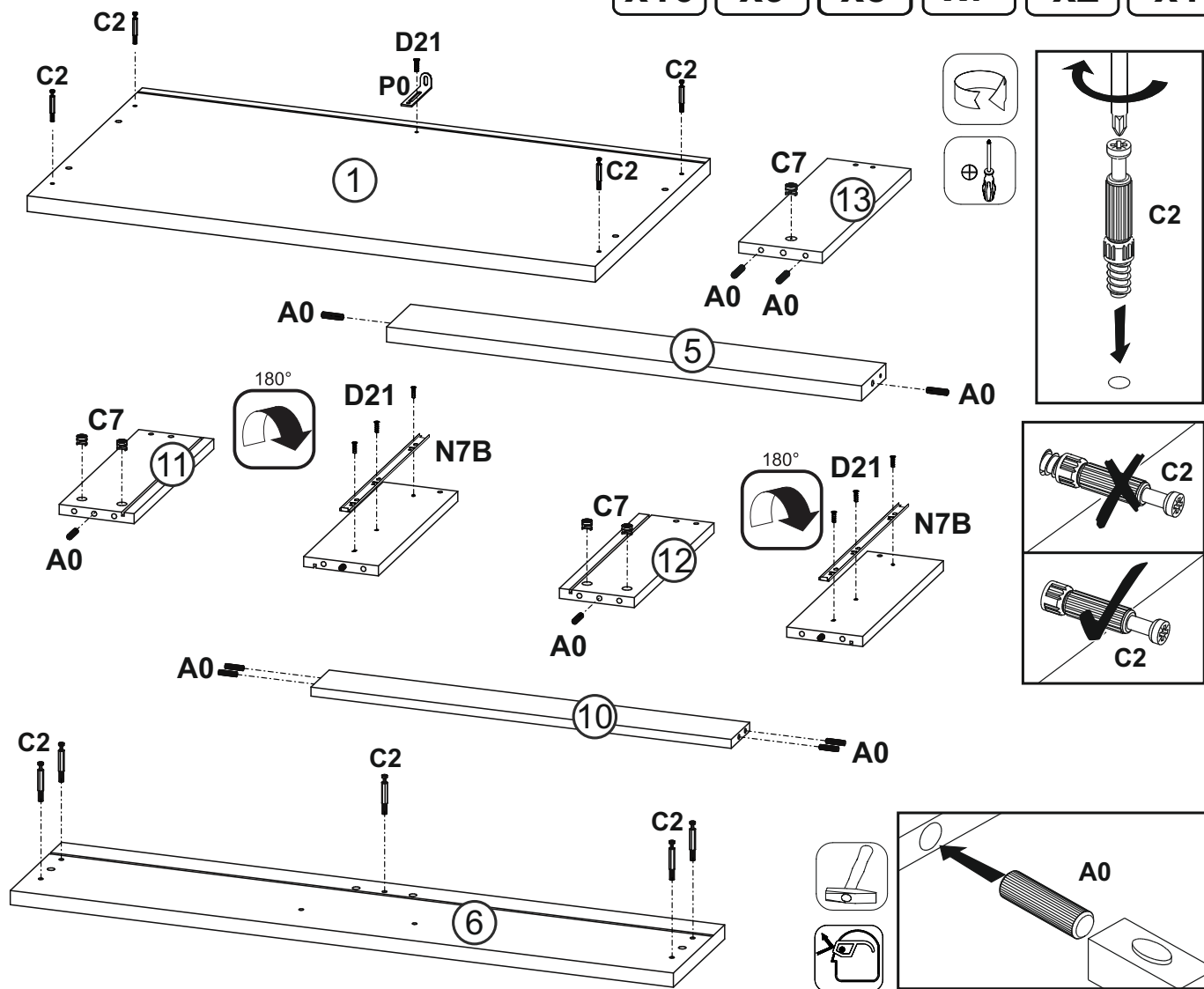

3

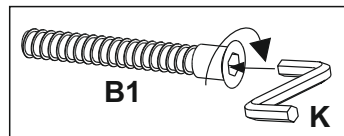





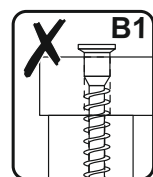
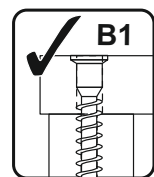
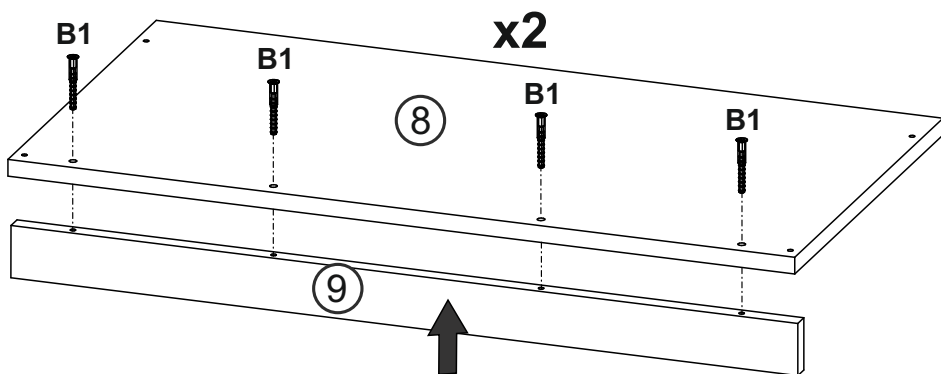



B1
∅7x50
x8

K
4mm
x1



4

B0	B1	C0	D0	D13	K	M1	T8	U0
								
ø 7mm	ø7x50	ø16mm	3x15	4x30	4mm			
x2	x2	x4	x4	x2	x1	x4	x10	x2

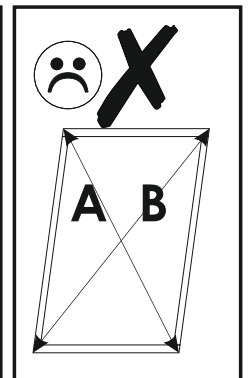
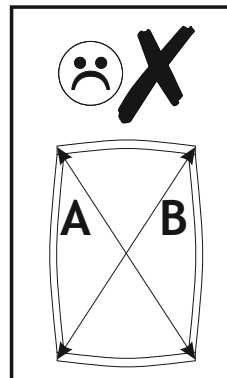
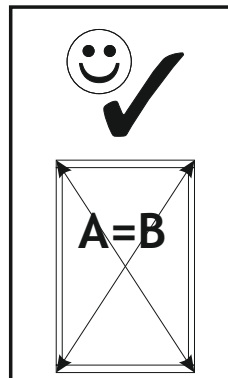
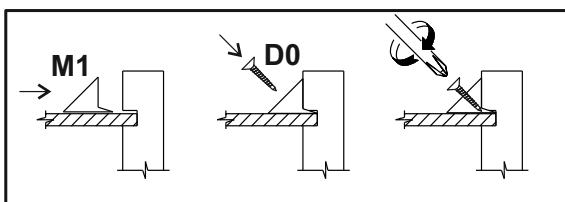
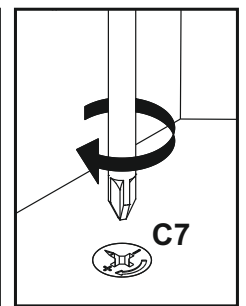
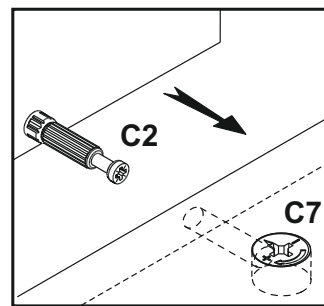
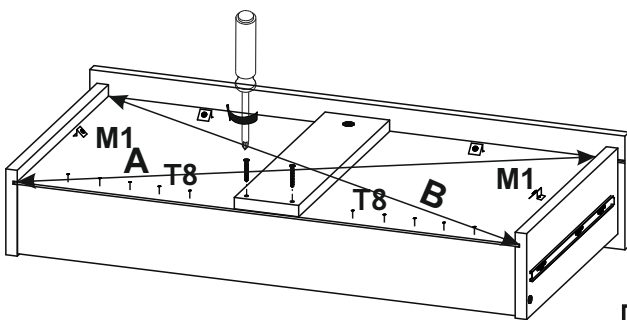
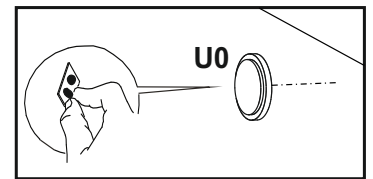
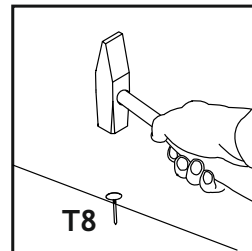
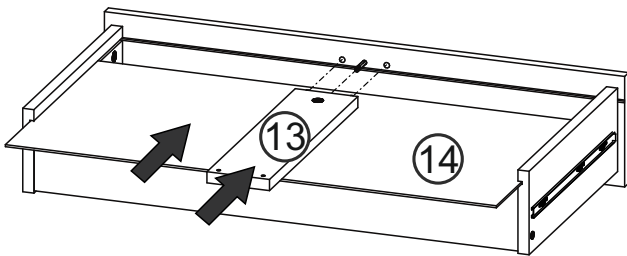
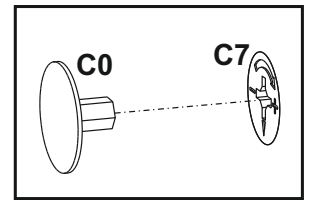
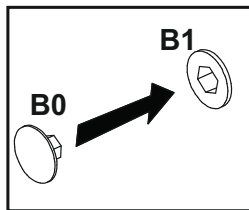
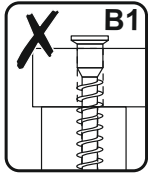
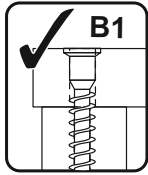
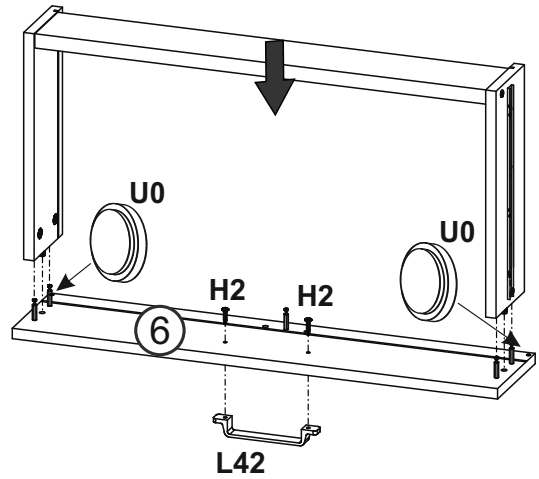
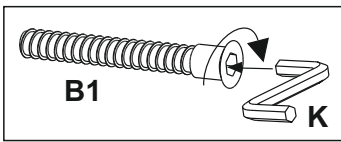
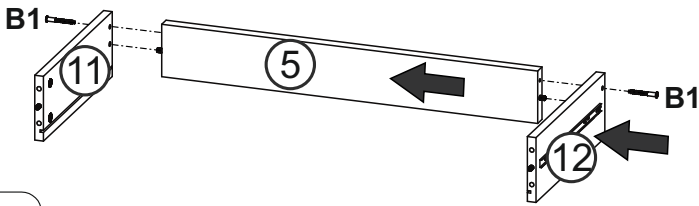

5

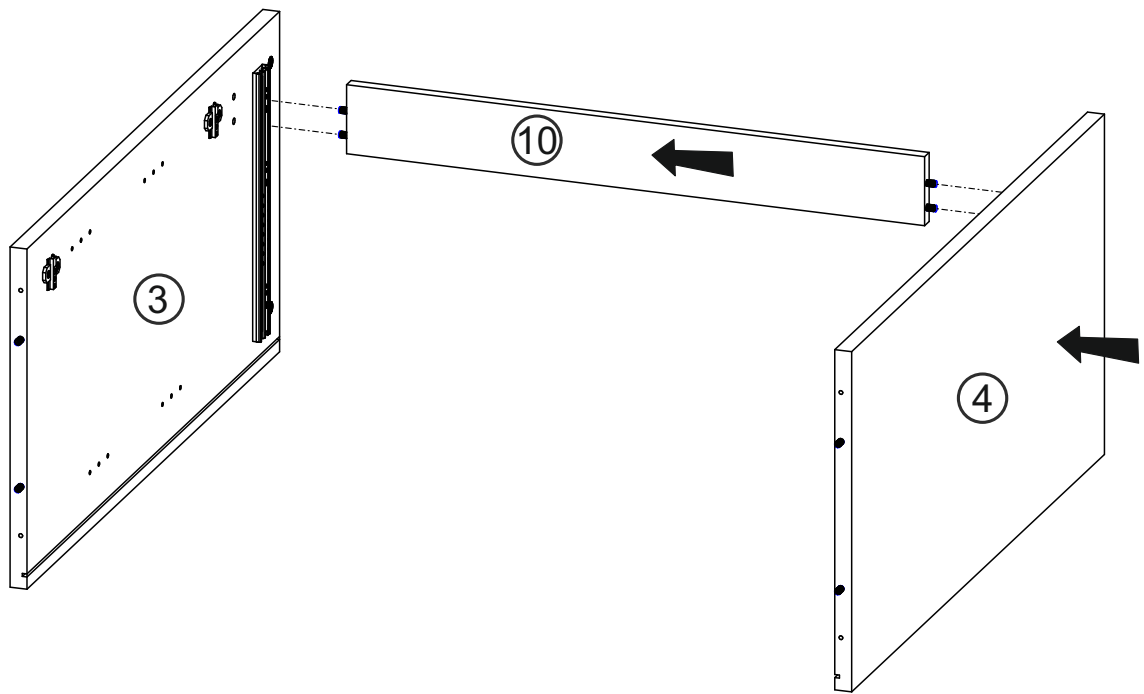

6

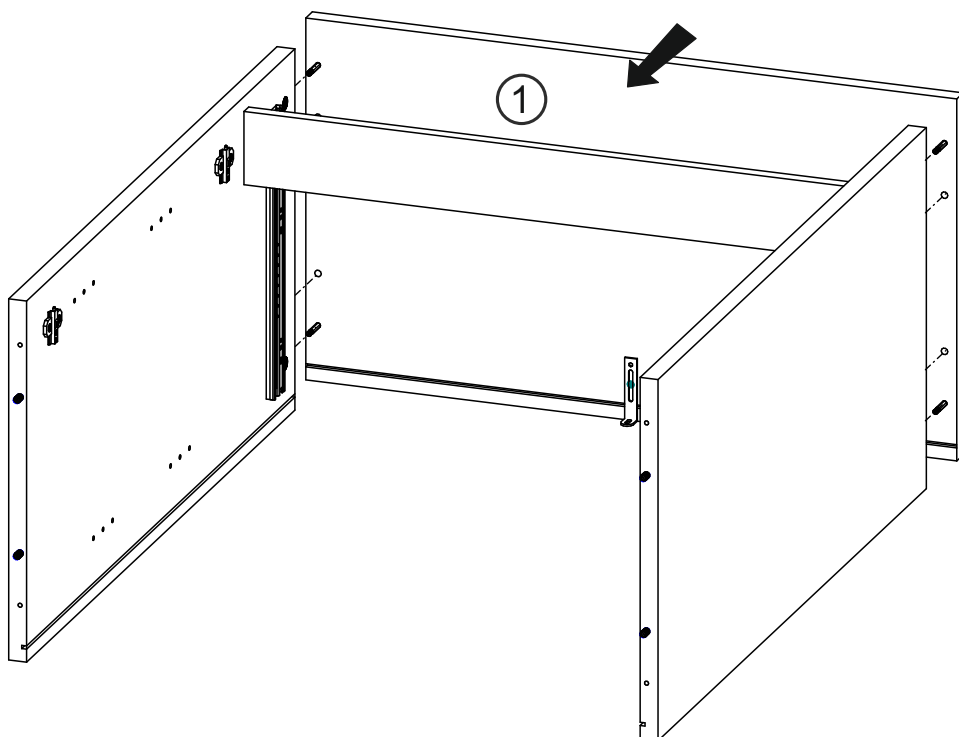
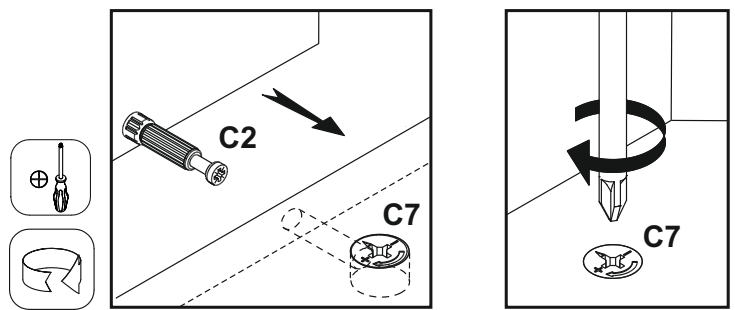

7

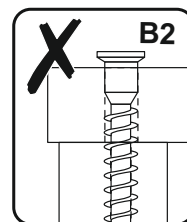
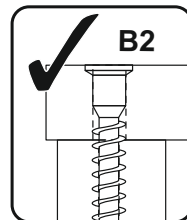
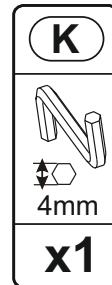
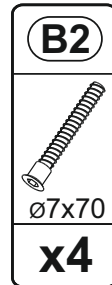
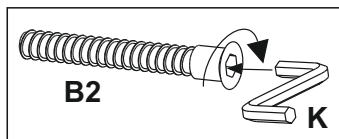
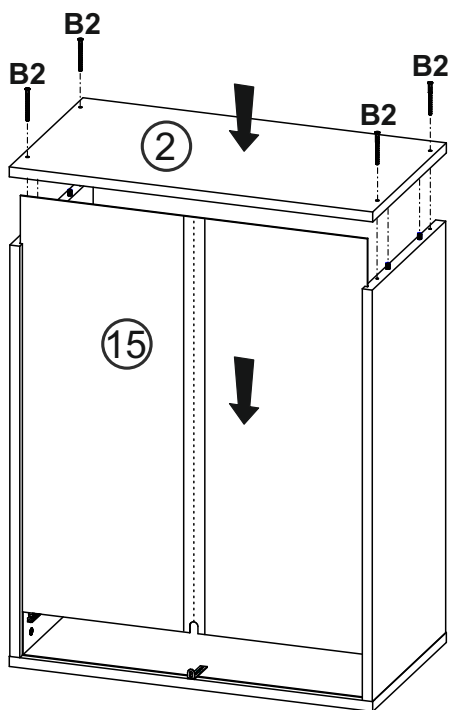

8

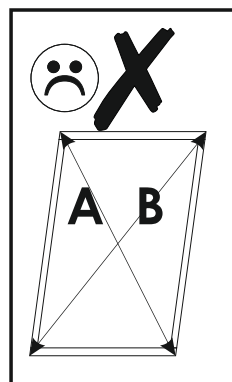
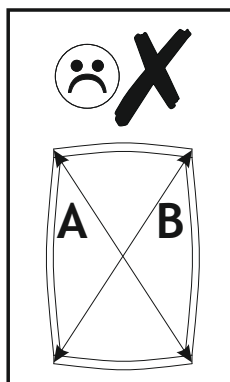
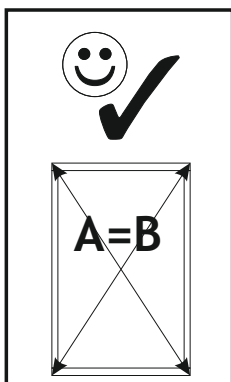
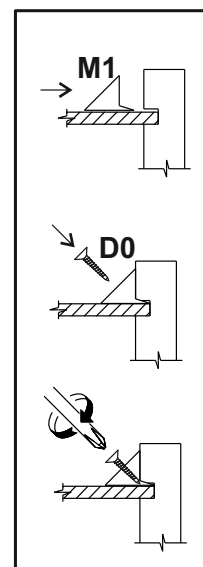
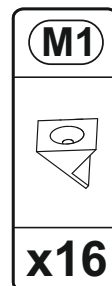
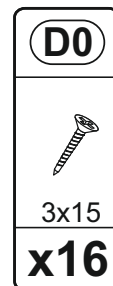
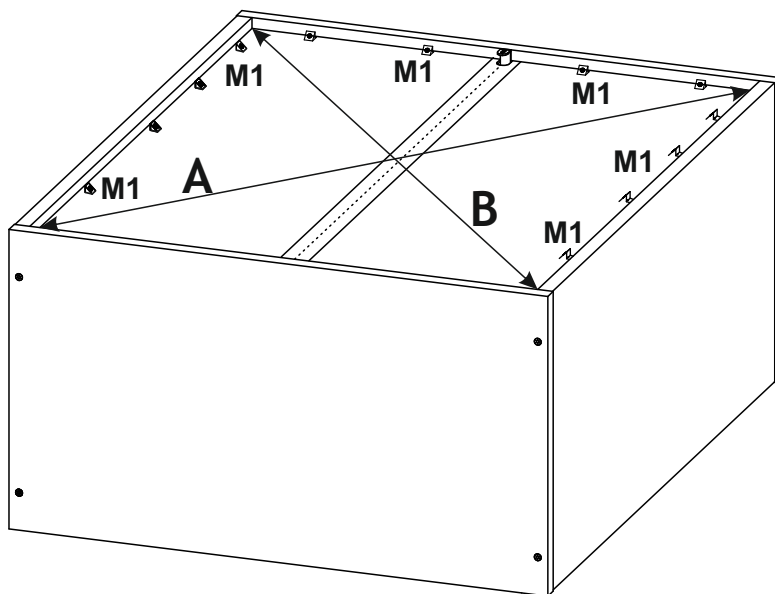

9

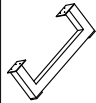
D5	T25
	
3,5x16	
x12	x2

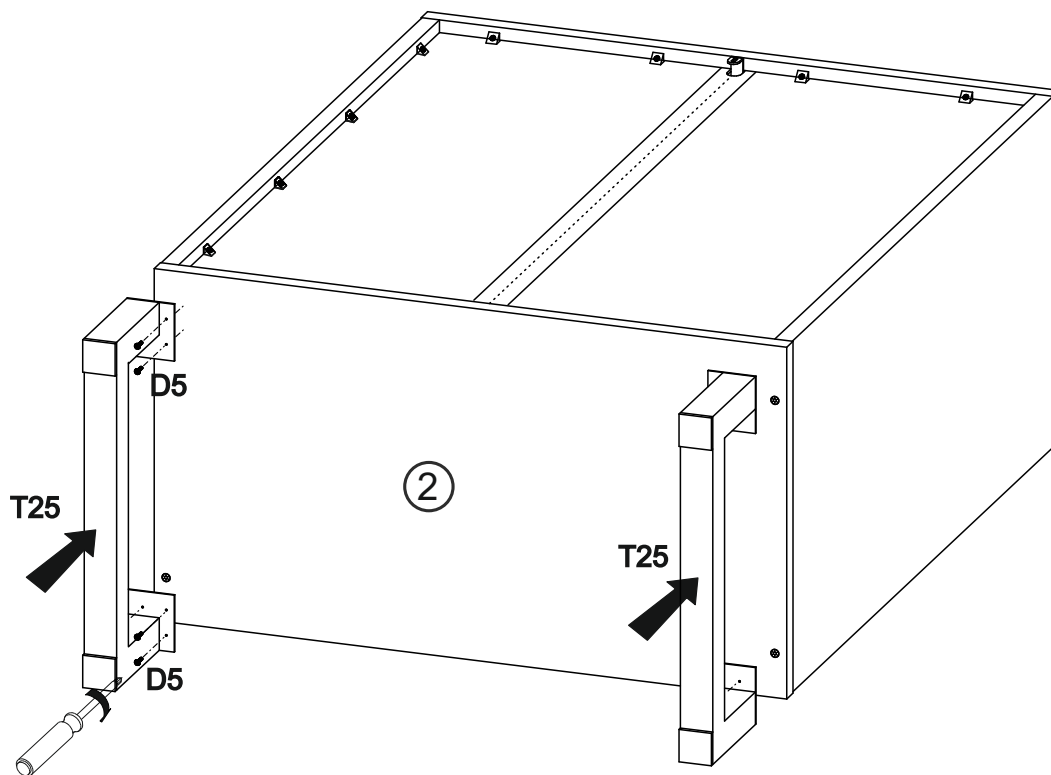
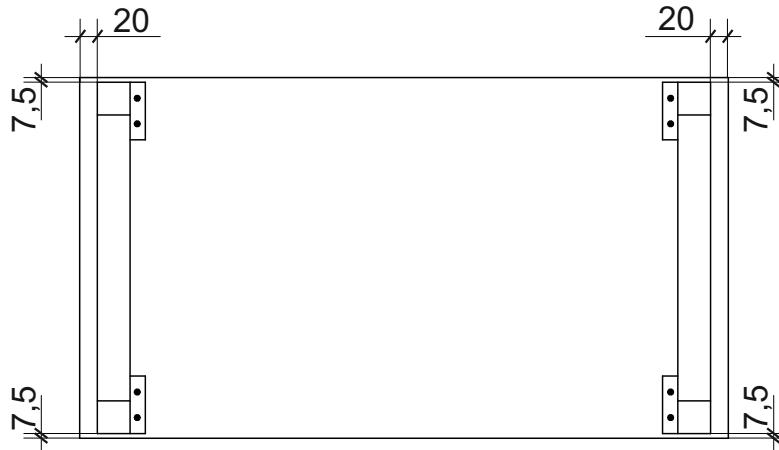
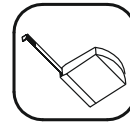

10

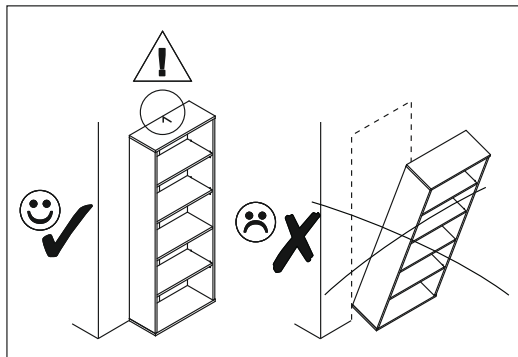
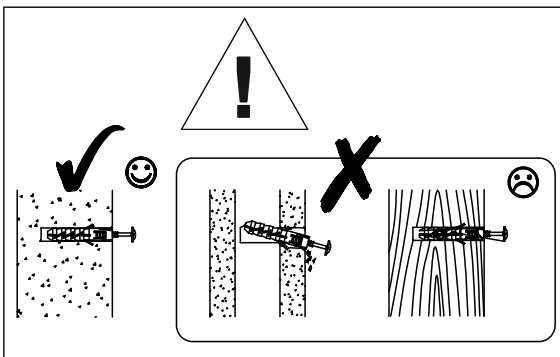
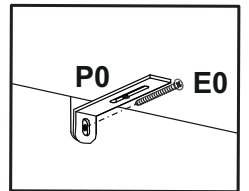
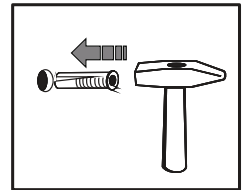
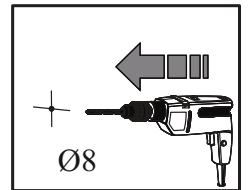
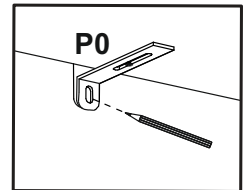
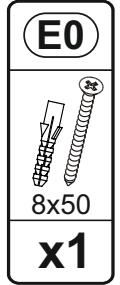
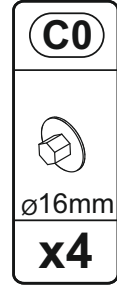
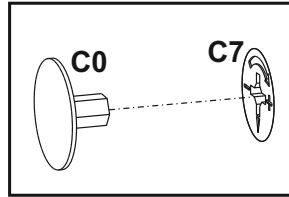
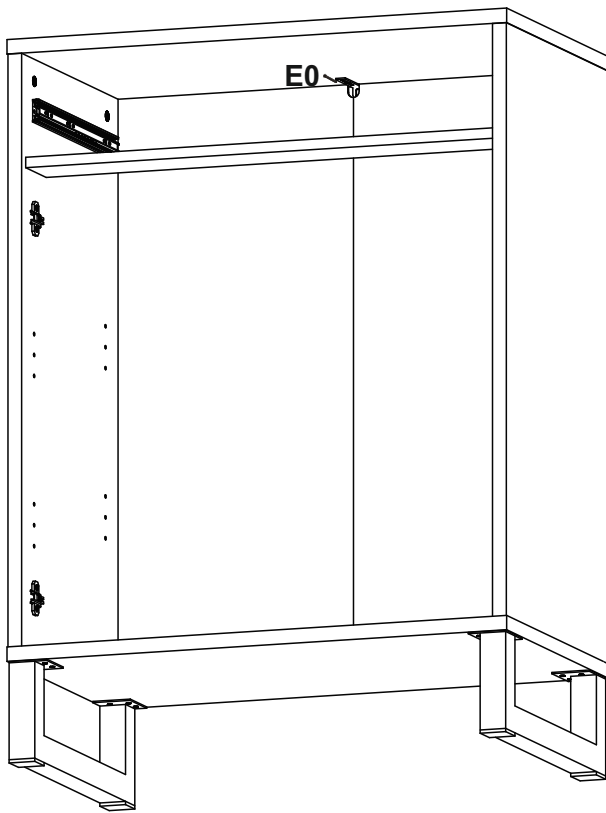

11

