









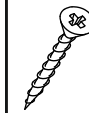
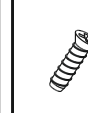
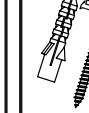

| | | | | | | | | | |
|---|---|---|---|---|---|---|--|---|---|
| B2 | D13 | D14 | D22 | E3 | K | P1 | P36 | P37 | U0 |
|  |  |  |  |  |  |  |  |  |  |
| ø7x70 | 4x30 | 4x35 | 5x11 | 10x50 | 4mm | | | | |
| x6 | x6 | x4 | x4 | x2 | x1 | x2 | x1 | x3 | x2 |

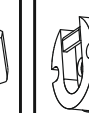

| | | | | | |
|---|-----|-----|----|----|-----|
| ① | 800 | 250 | 22 | x1 | 1/1 |
| ② | 798 | 775 | 16 | x1 | 1/1 |
|  | | | | | 1/1 |

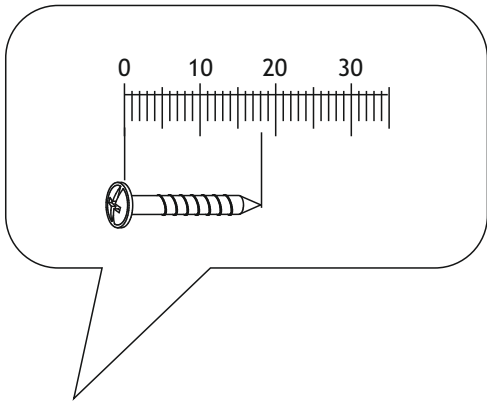

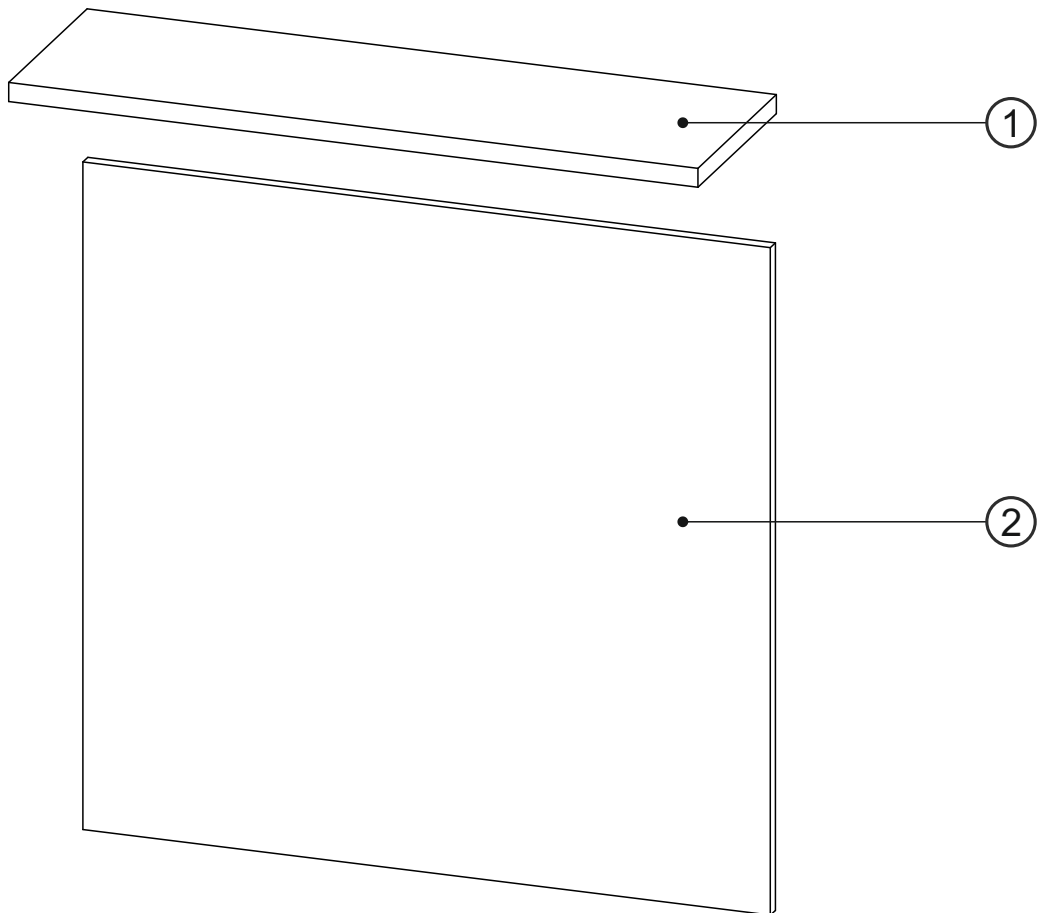
1

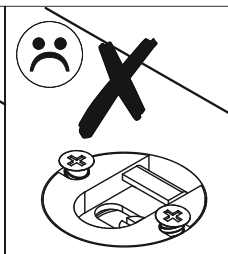
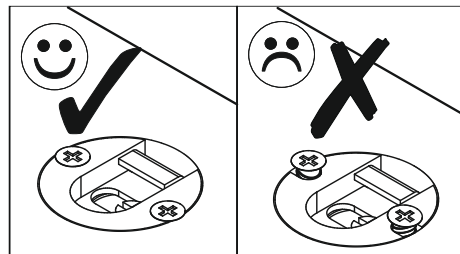
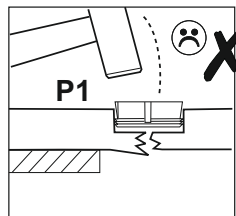
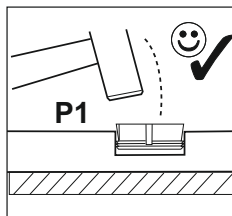
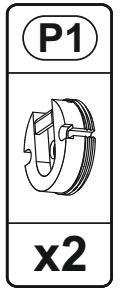
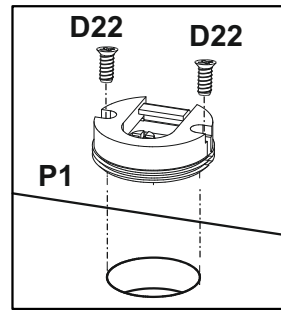
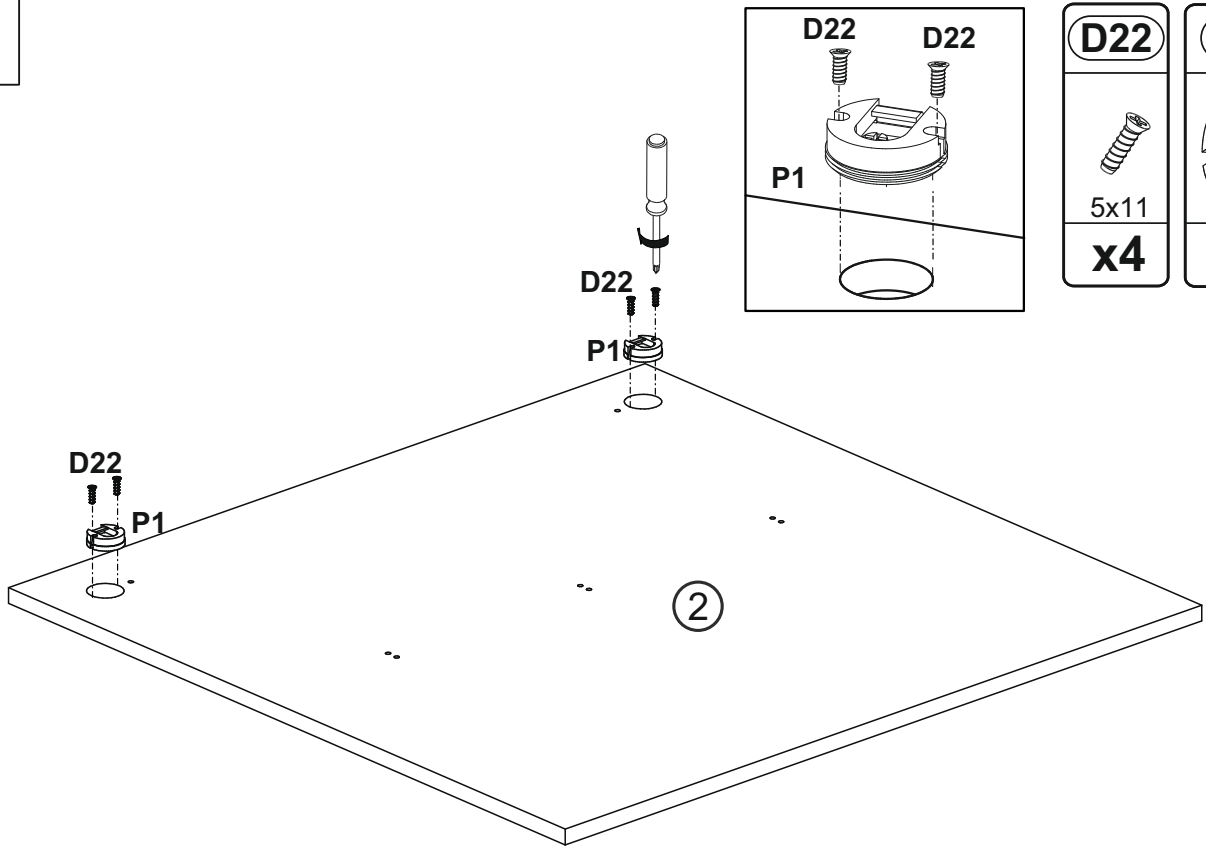

2

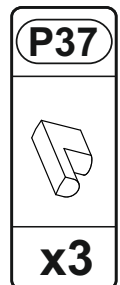
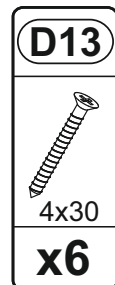
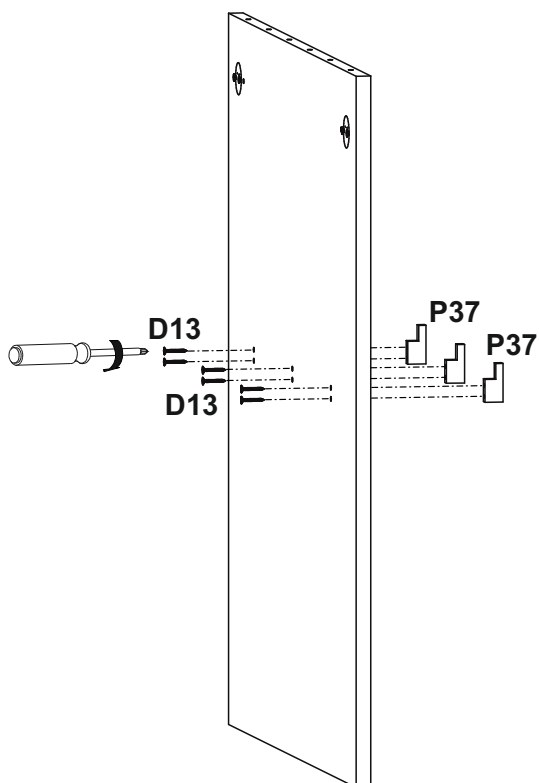

3

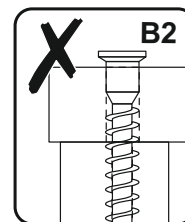
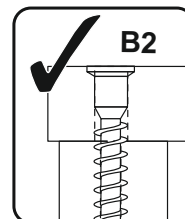
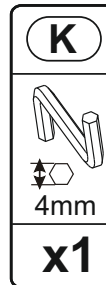
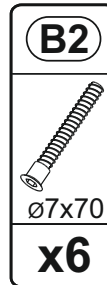
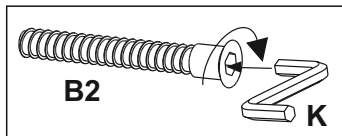
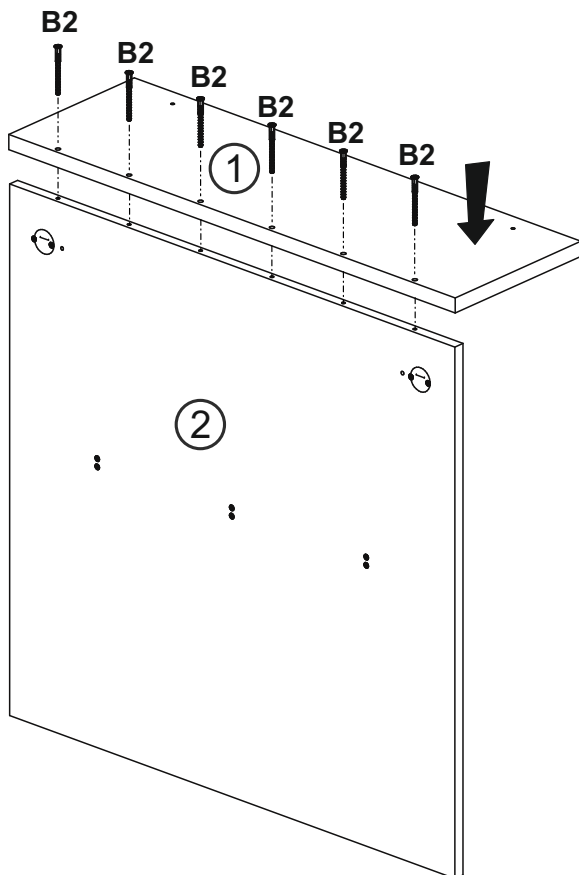

4

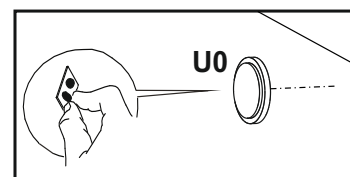
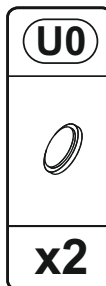
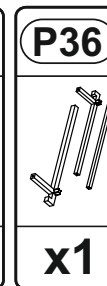
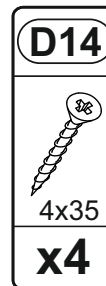
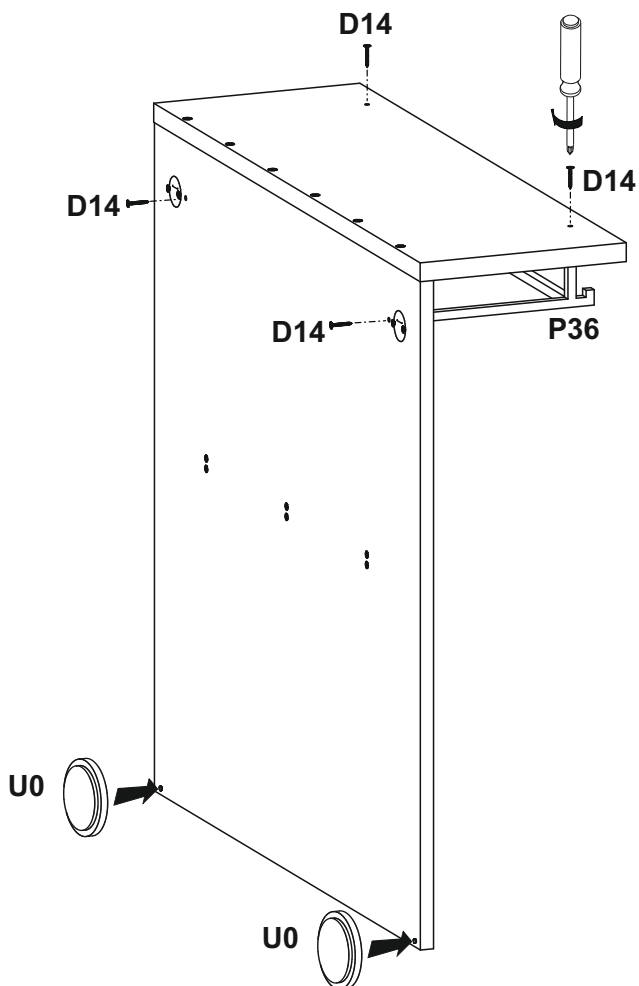

5



E3

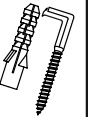

10x50

x2

