























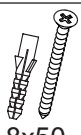



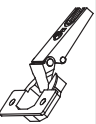

A0	B0	B1	C0	C2	C7	C9	C10	C13	D0	D3
										
Ø8x30		Ø7x50			16mm		6,3x20	6,3x16	3x15	3,5x10
x22	x4	x4	x16	x20	x20	x12	x8	x4	x32	x2

D4	D5	D14	D21	E0	H2	J5	J6	J8	K	L42
										
3,5x18	3,5x16	4x35	5x13	8x50	4x22		H=2	4mm		
x1	x24	x9	x1	x1	x6	x4	x12	x8	x1	x3

M1	O0	P0	S0	T3	Q3	U0
						
			L-943			
x32	x2	x1	x1	x16	x12	x6



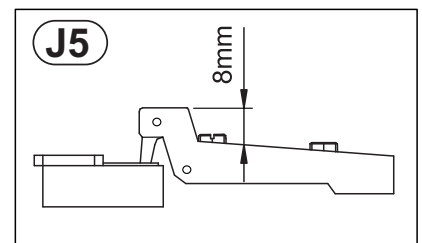
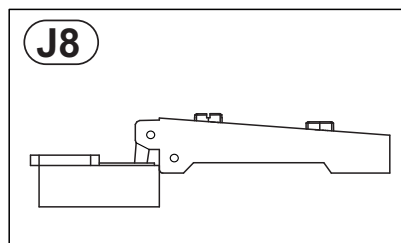
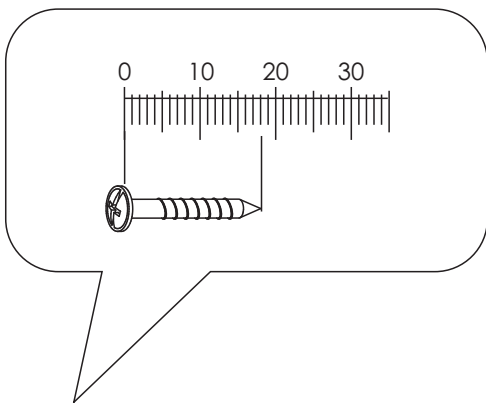
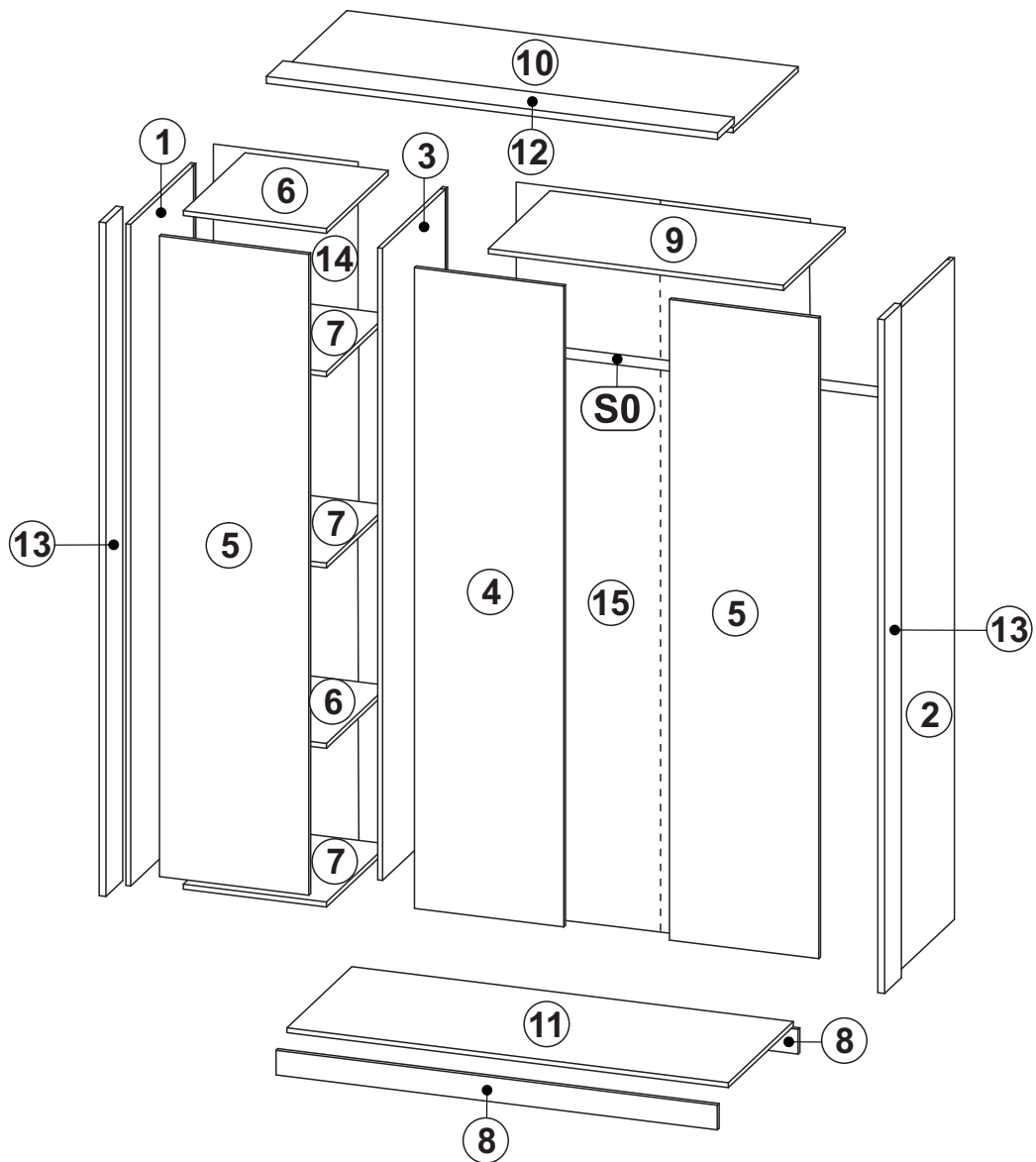

①	2148	580	16 x1	2/4
②	2148	580	16 x1	2/4
③	2052	580	16 x1	2/4
④	2080	485	16 x1	4/4
⑤	2080	485	16 x2	4/4
⑥	464,5	550	16 x2	1/4
⑦	464,5	550	16 x2	1/4
⑦	464,5	550	16 x1	2/4
⑧	1433	80	16 x2	3/4







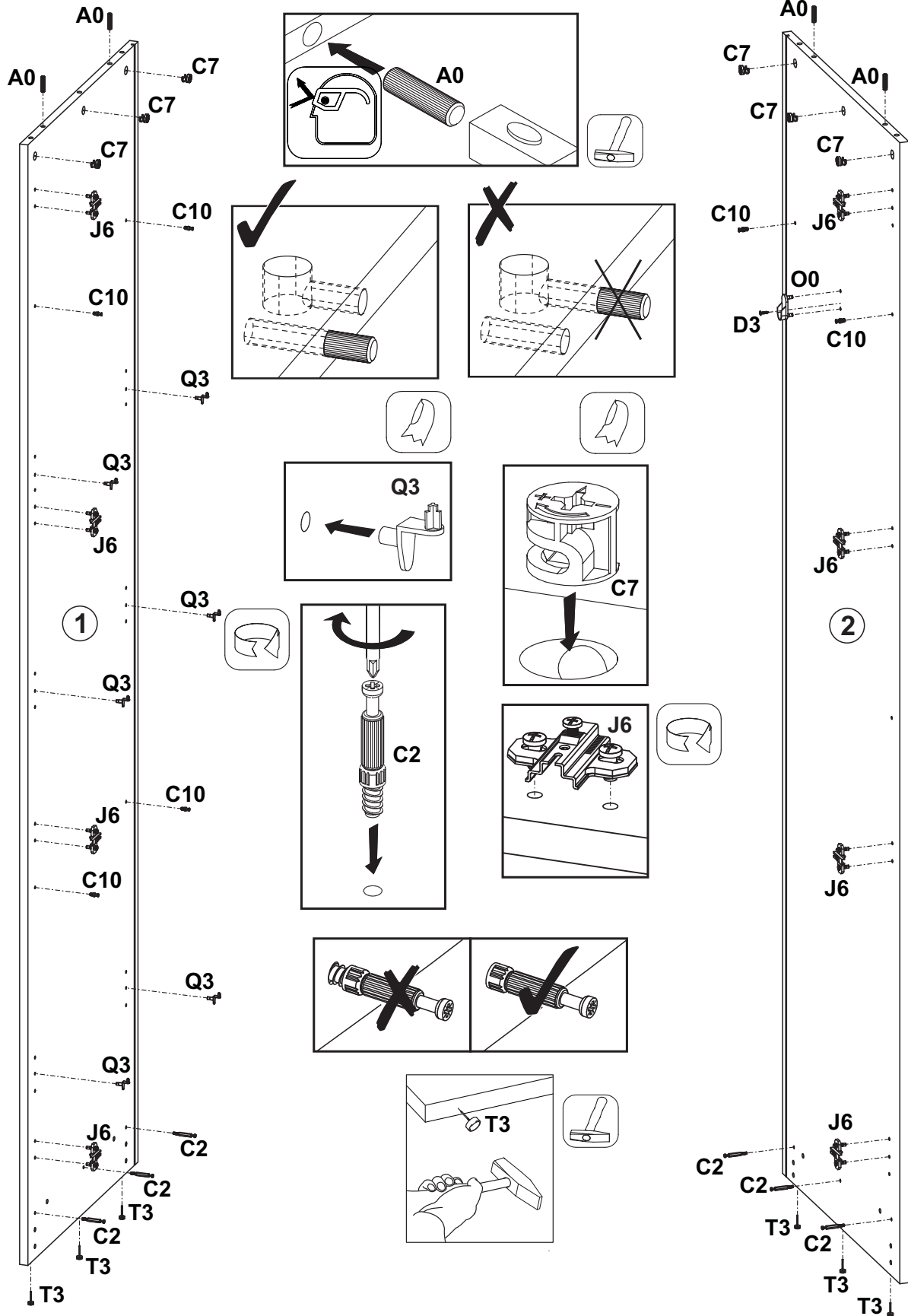

⑨	952	550	16 x1	1/4
⑩	1466	580	16 x1	2/4
⑪	1433	580	16 x1	2/4
⑫	1953	148	22 x1	3/4
⑬	2187	150	22 x2	3/4
⑭	2062	475	2,8 x1	4/4
⑮	2062	960	2,8 x1	4/4
S0				3/4
				1/4

1

A0 Ø8x30 x4	C2 x6	D3 3,5x10 x1	C7 16mm x6	C10 6,3x20 x6	J6 H=2 x8	Q3 x6	T3 x6	O0 x1
-------------------------------------	----------------------------	--------------------------------------	------------------------------------	---------------------------------------	-----------------------------------	----------------------------	----------------------------	----------------------------





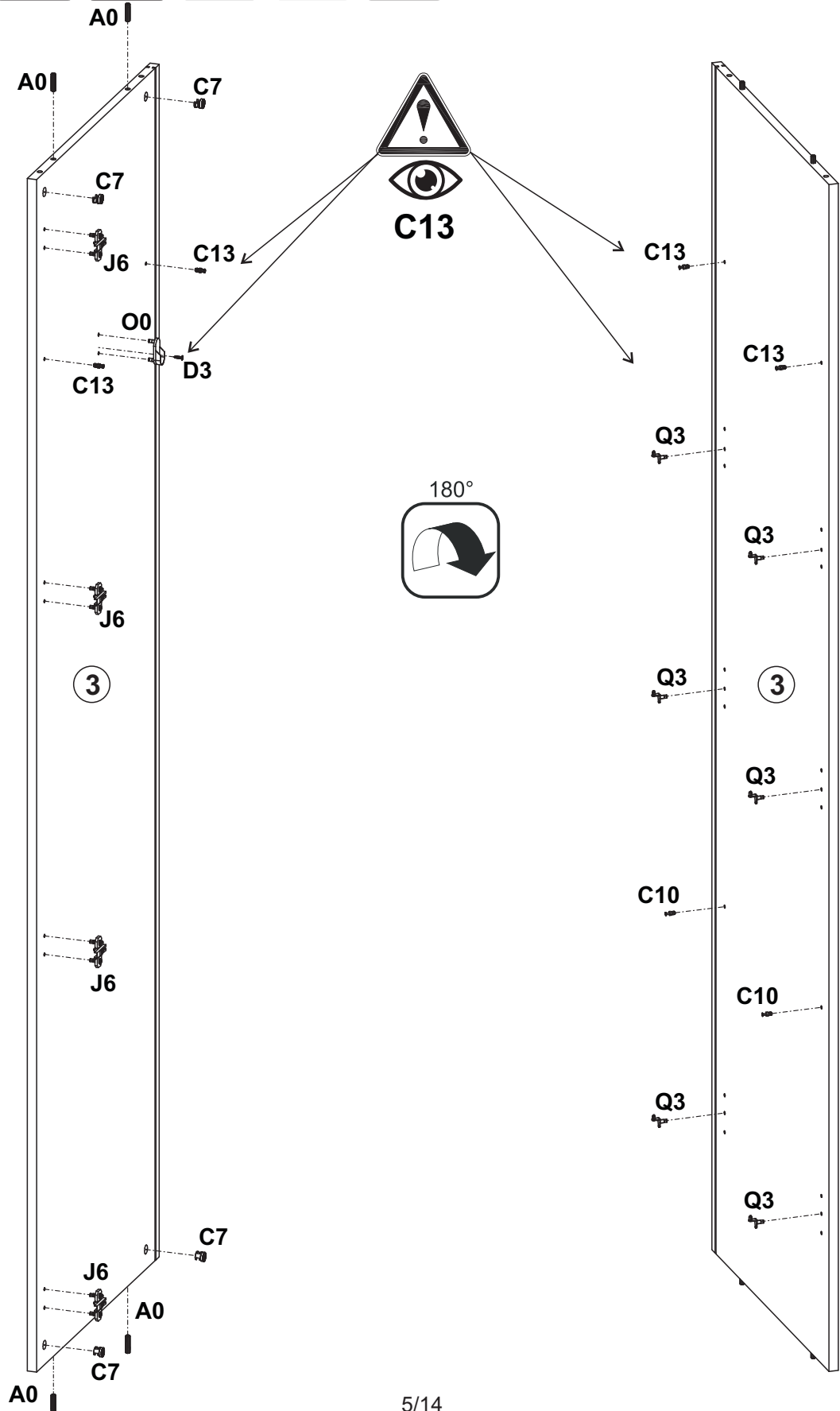

2

A0  Ø8x30 x4	C7  16mm x4	C10  6,3x20 x2	C13  6,3x16 x4	D3  3,5x10 x1	J6  H=2 x4	Q3  x6	O0  x1
--	---	--	--	---	--	--	---

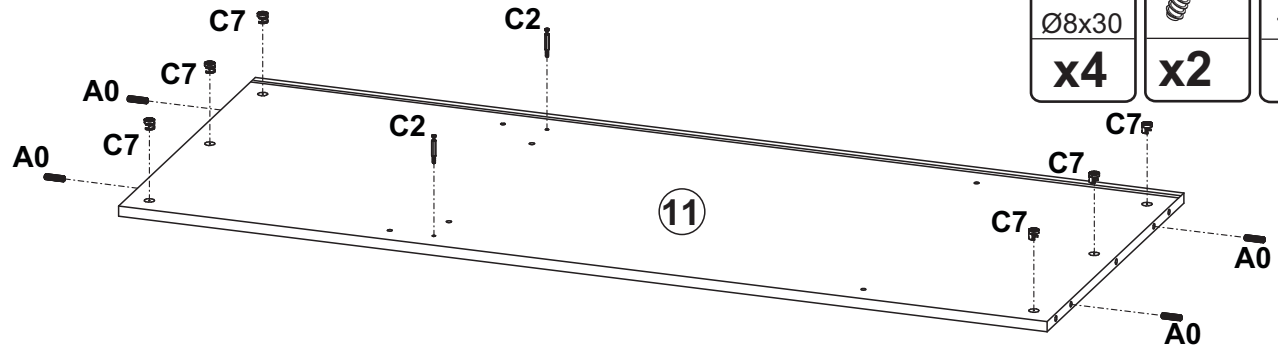





3

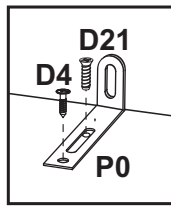
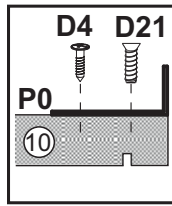
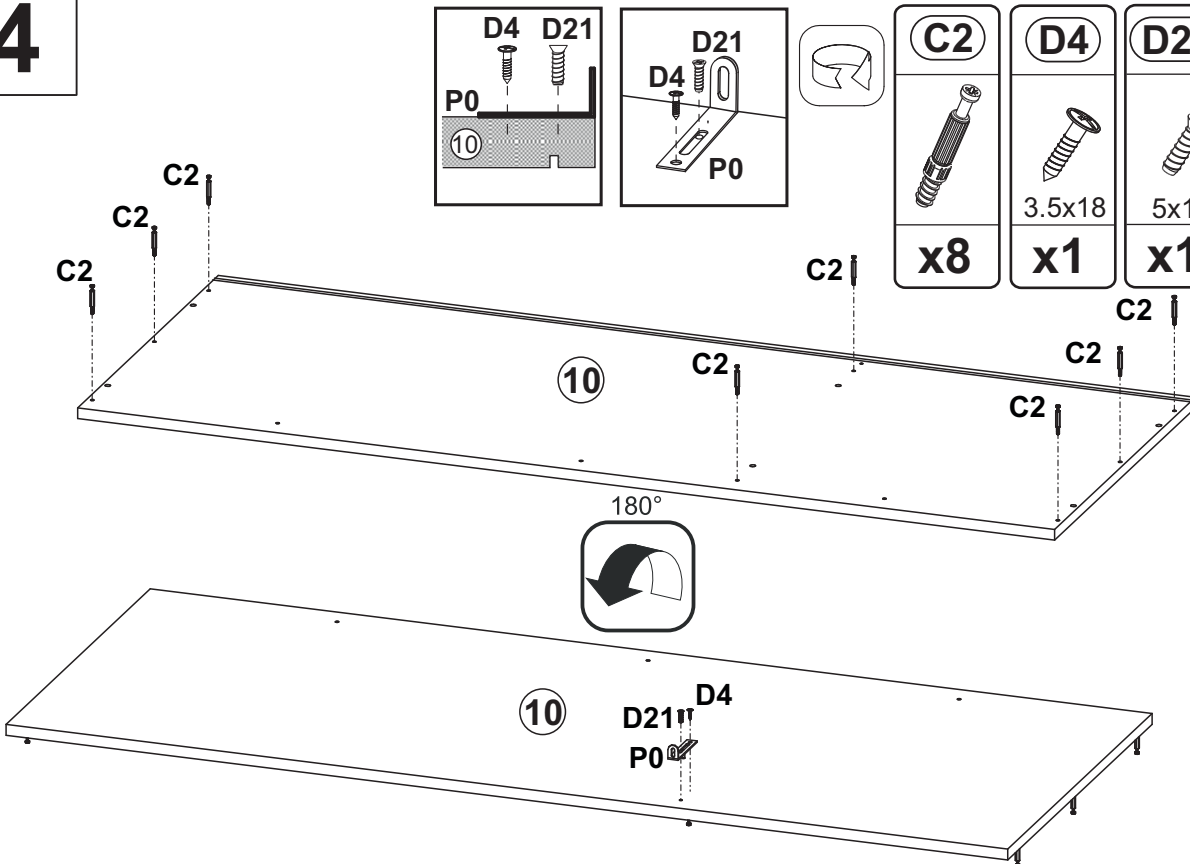

A0	C2	C7
		
Ø8x30		16mm
x4	x2	x6



4

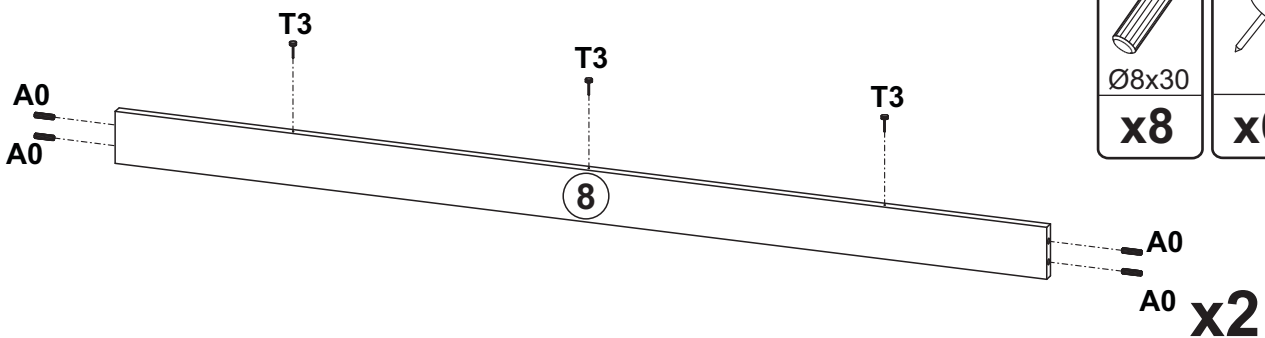

C2	D4	D21	P0
			
	3.5x18	5x13	
x8	x1	x1	x1

5



A0	T3
	
Ø8x30	
x8	x6

6

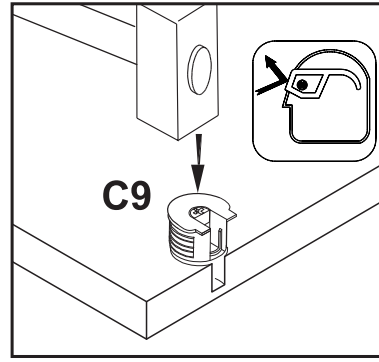
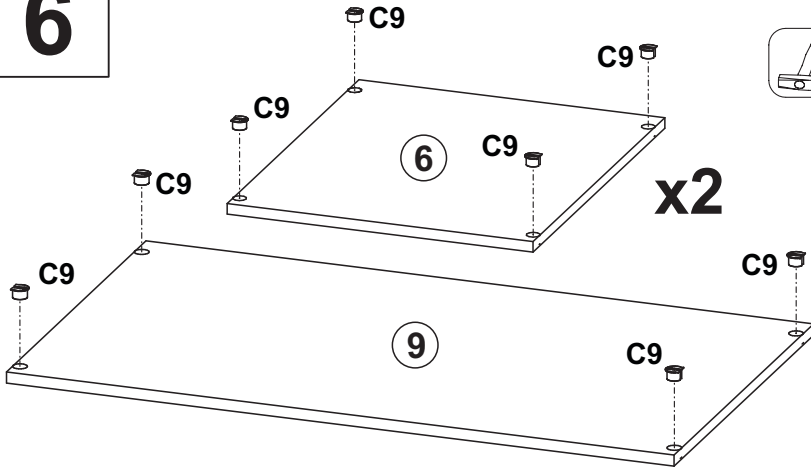

C9
x12

7

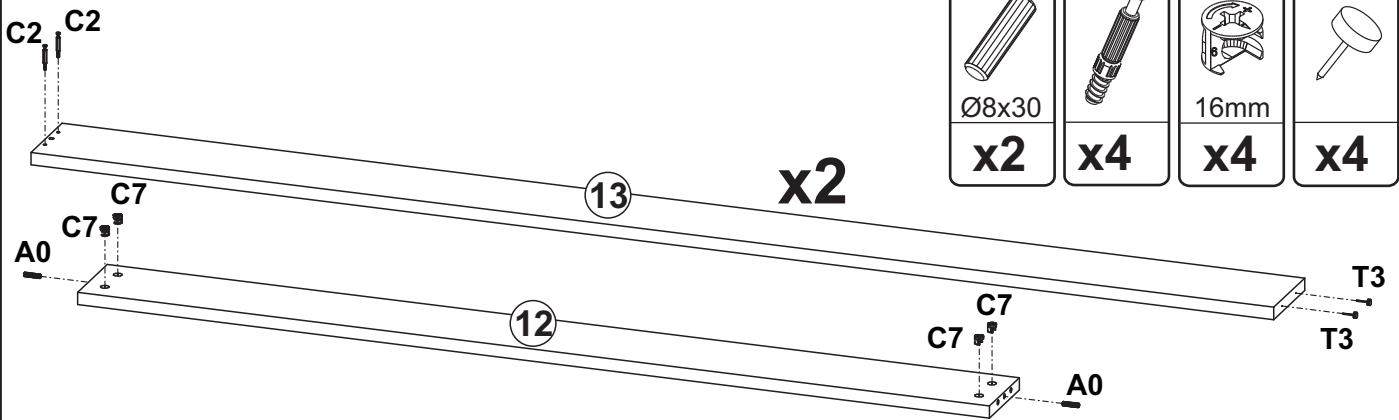

A0	C2	C7	T3
Ø8x30		16mm	
x2	x4	x4	x4

8

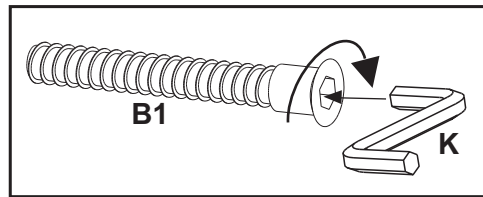
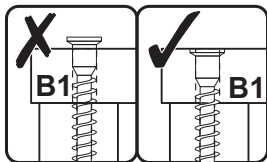

B1	K
Ø7x50	4mm
x4	x1

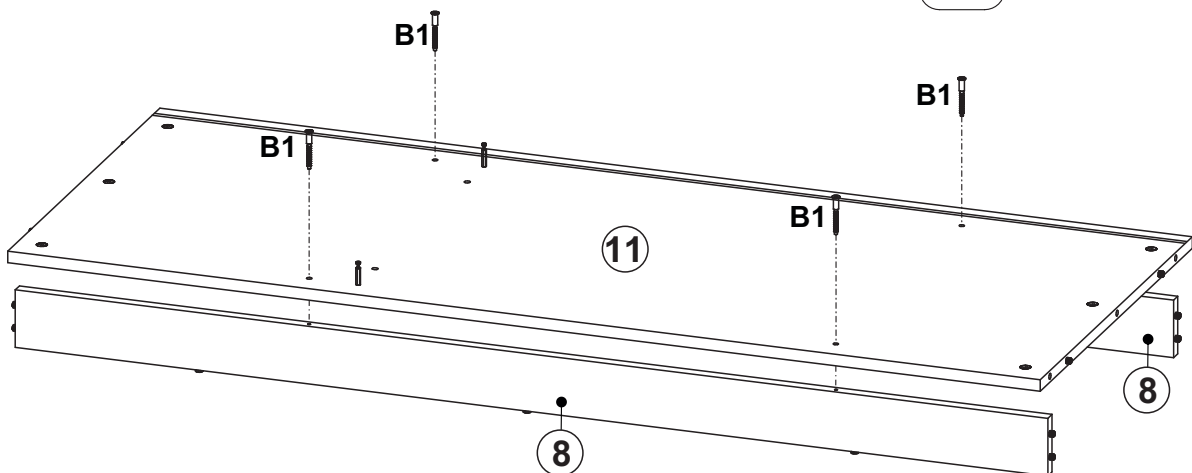

9

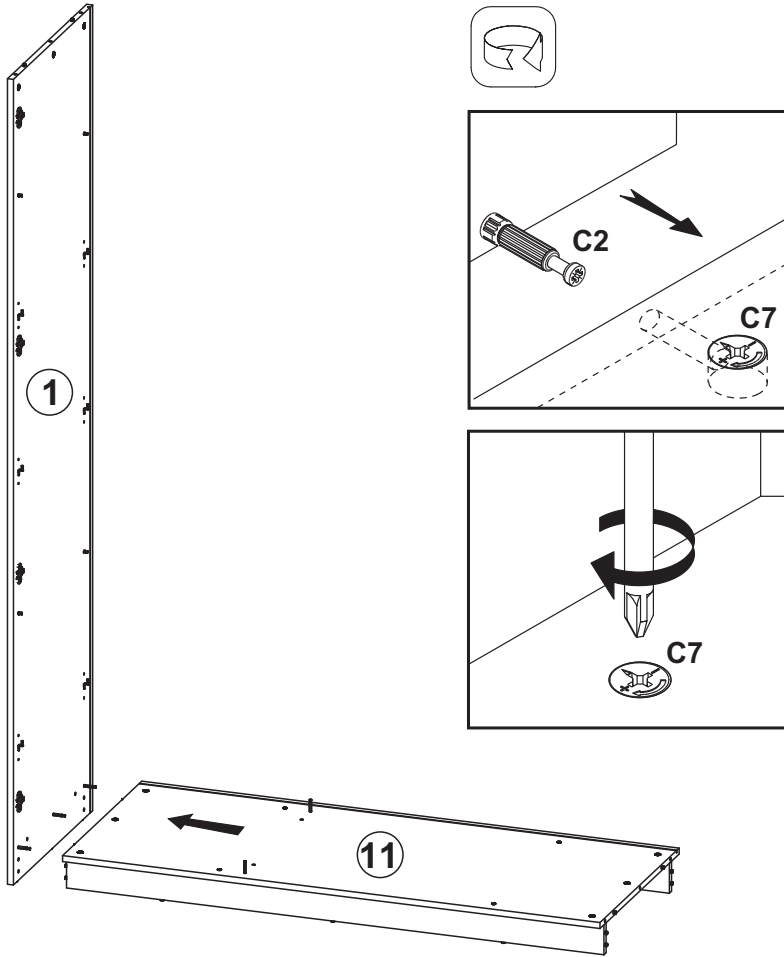

10

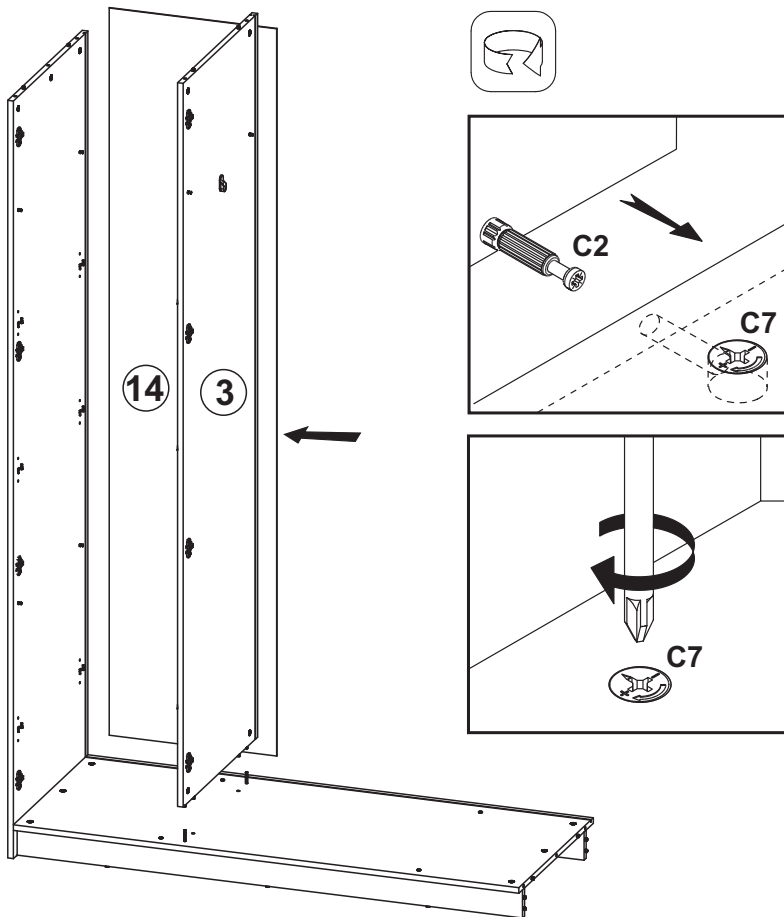

11

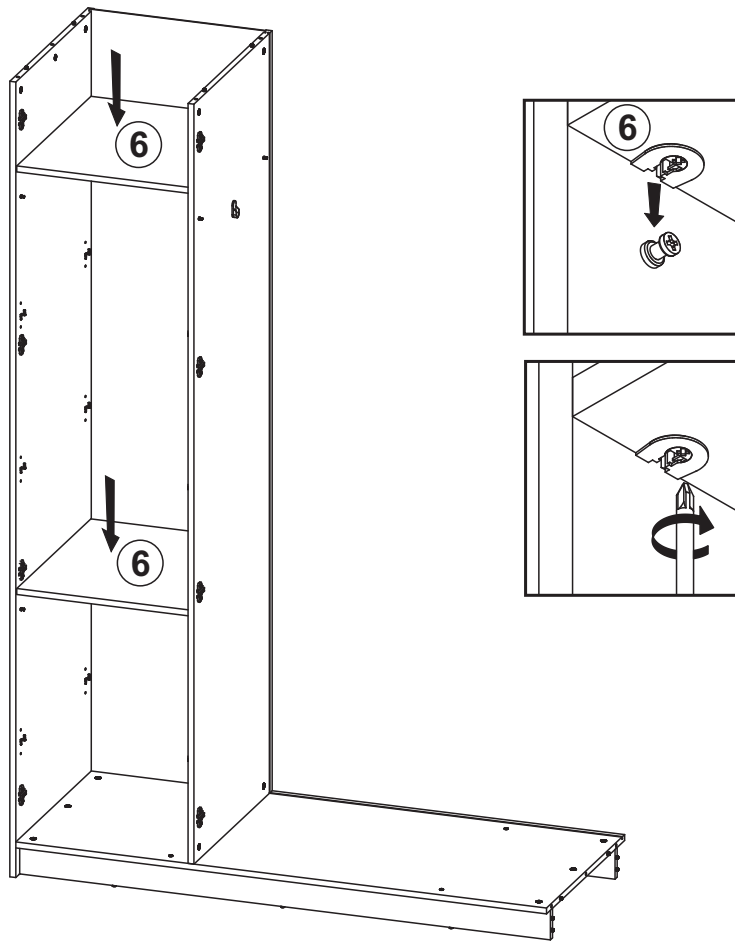

12

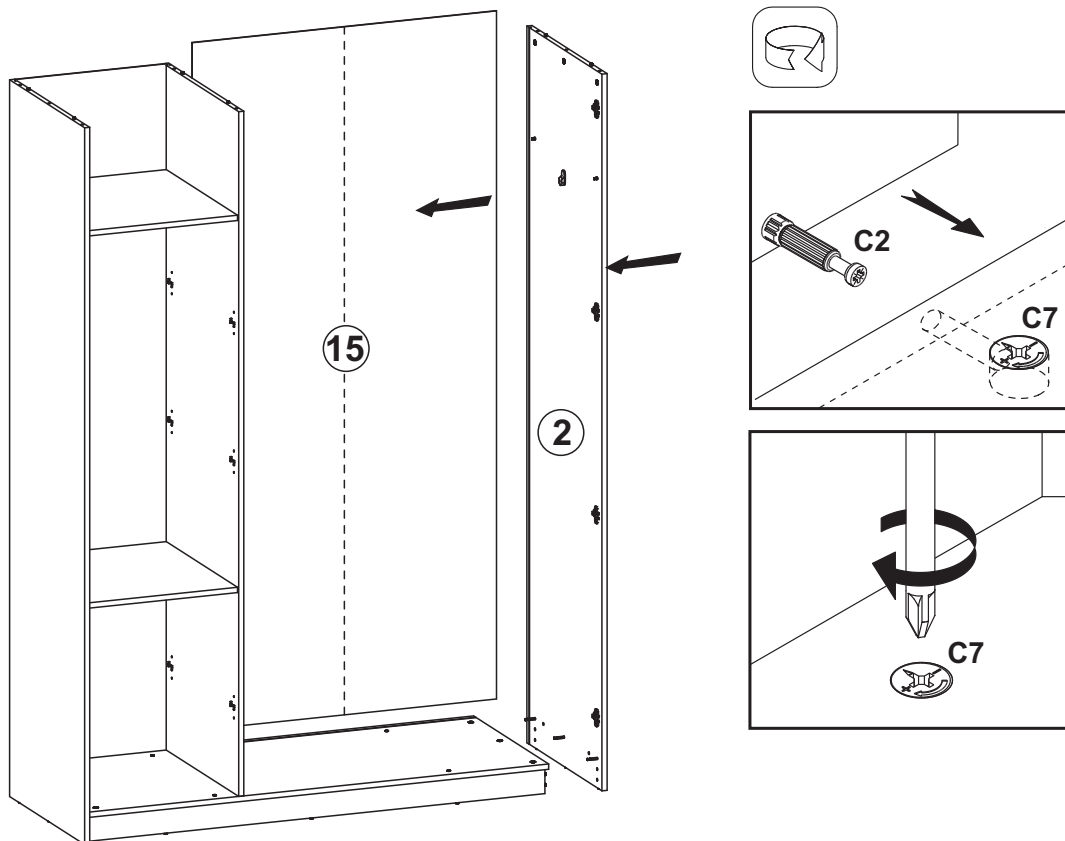

13

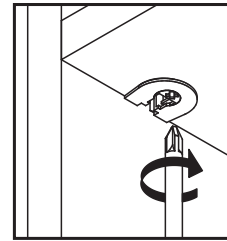
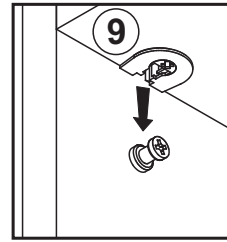
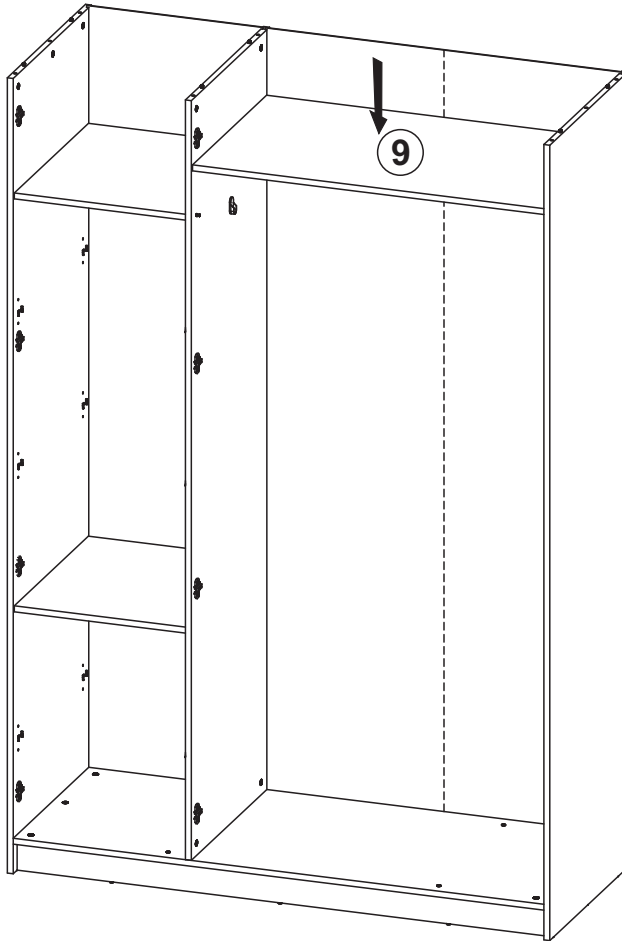

14

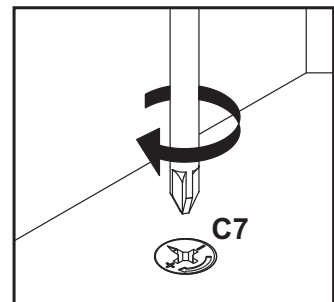
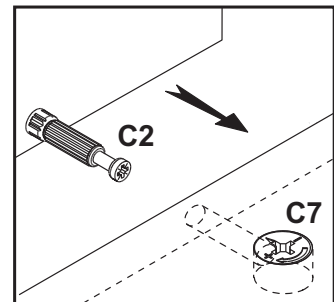
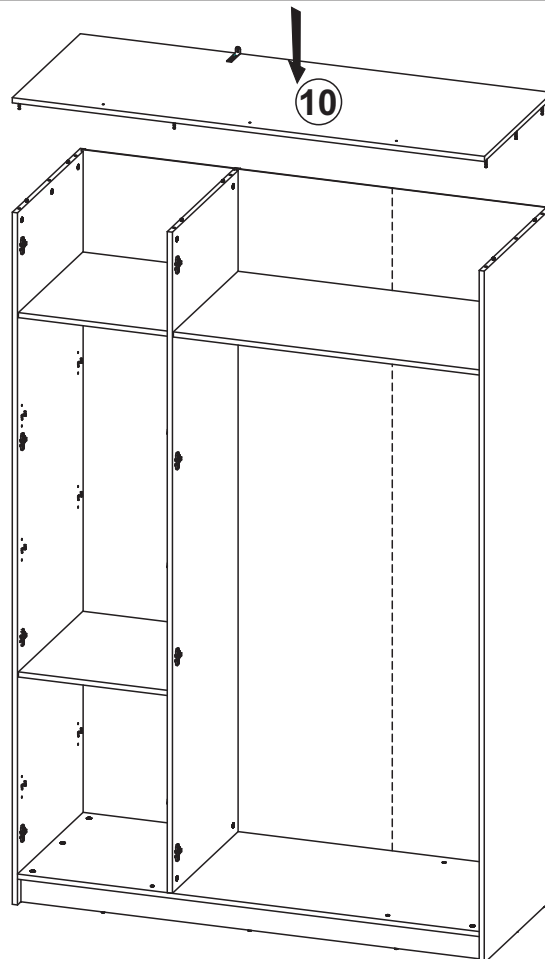

15

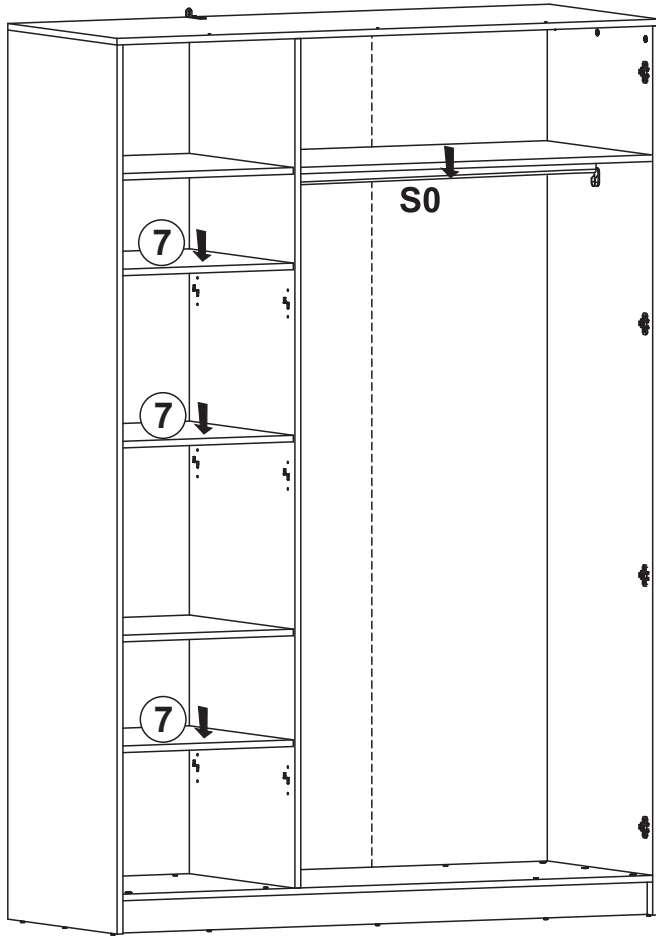

S0
0
L-949
x1

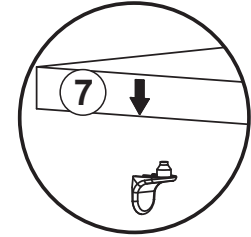
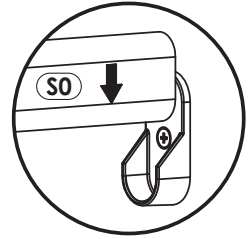

16

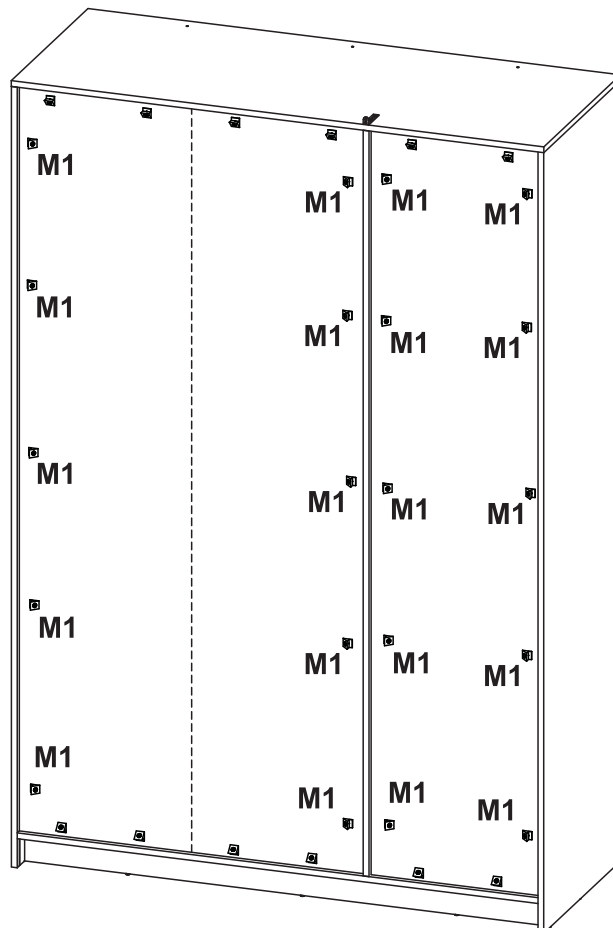
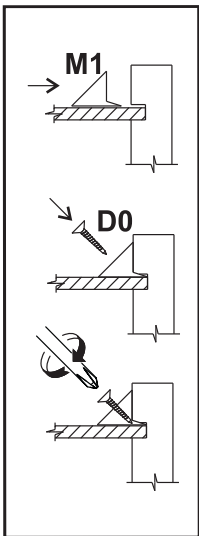

D0
3x15
x32

M1
x32

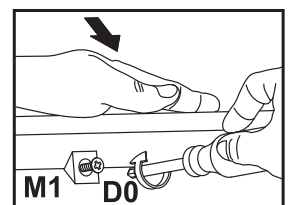
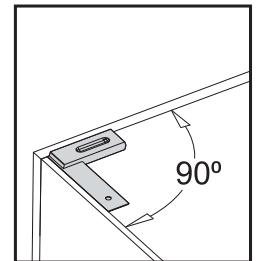

17

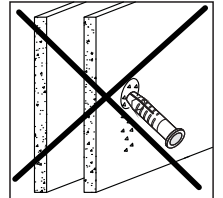
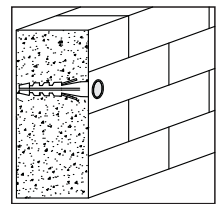
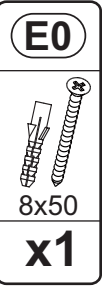
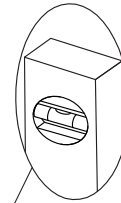
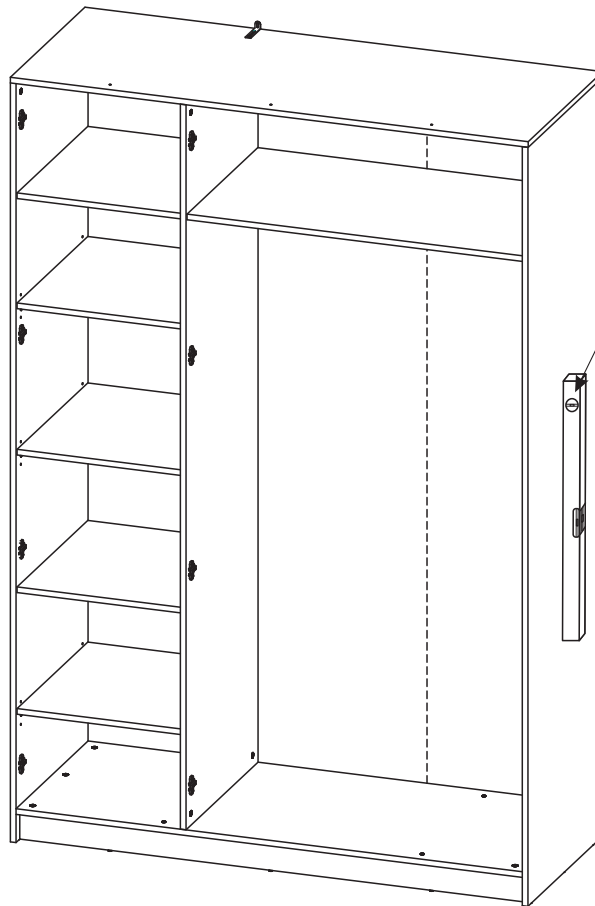
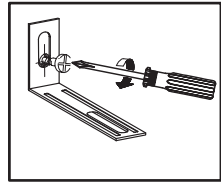
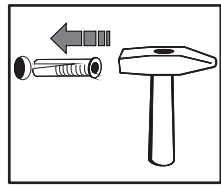
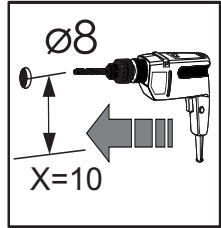
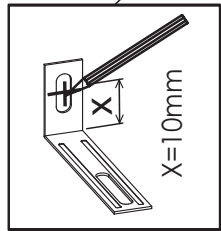

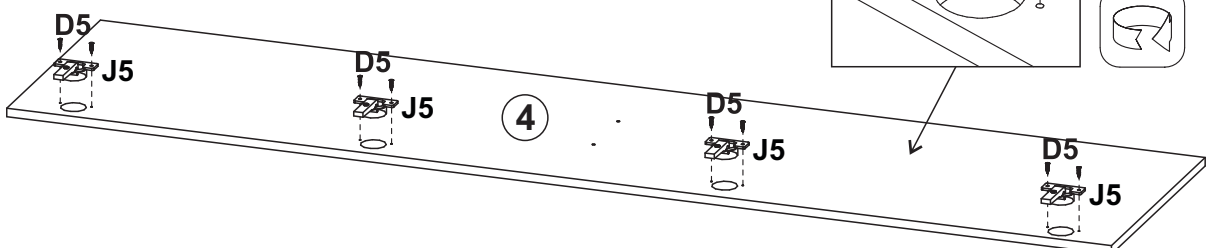
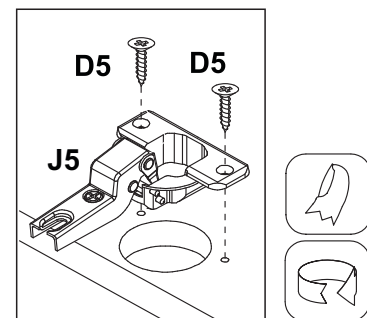
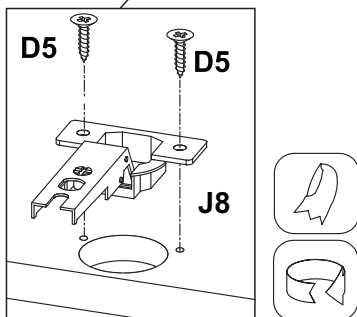
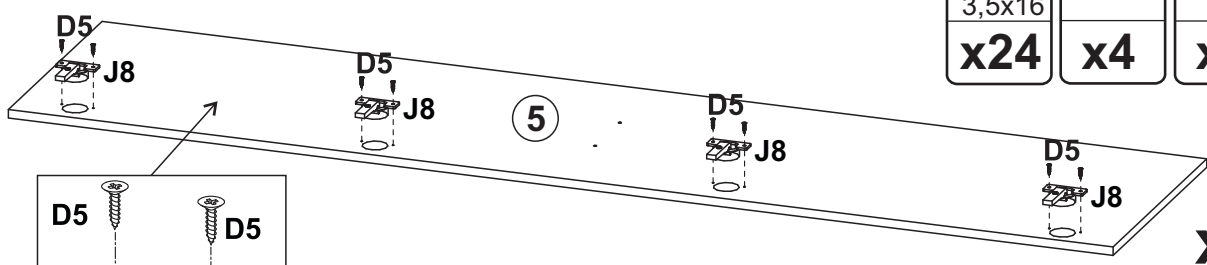
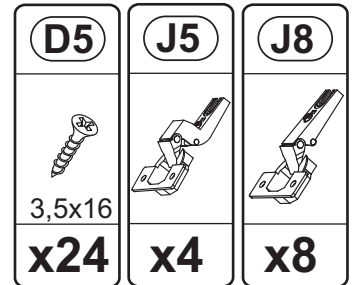

18

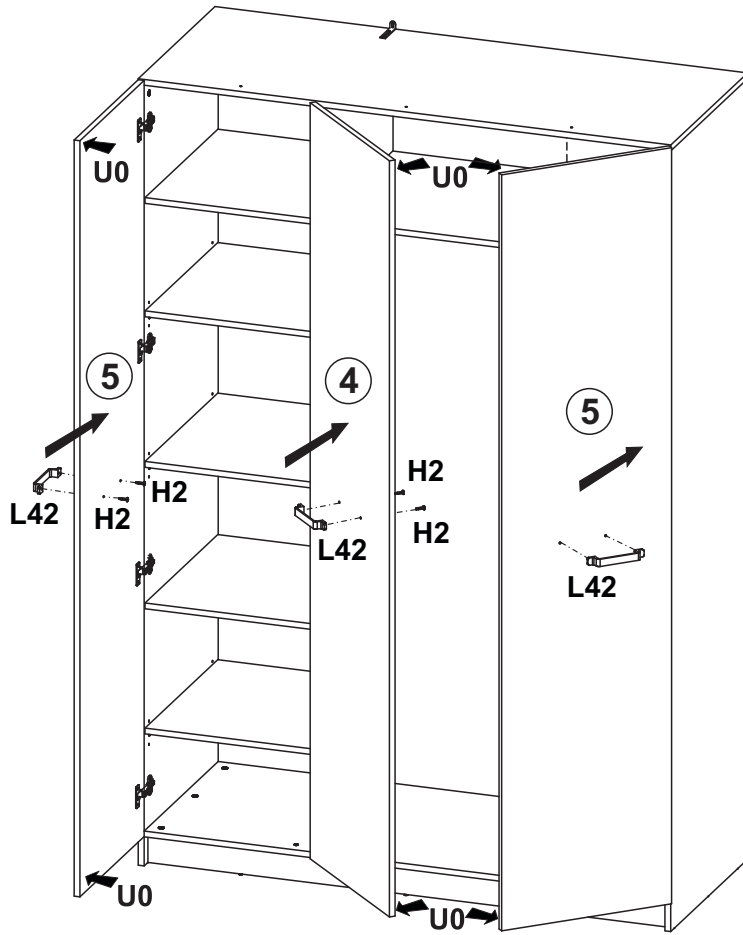

19



H2	L42	U0
		
4x22		
x6	x3	x6

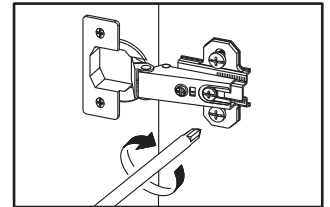
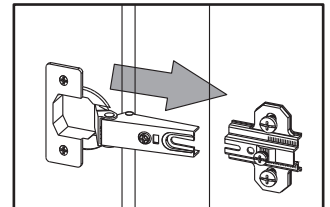

20

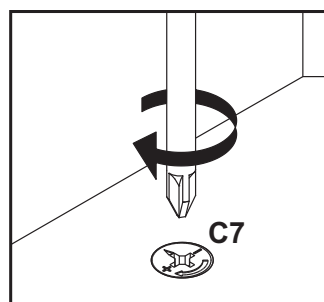
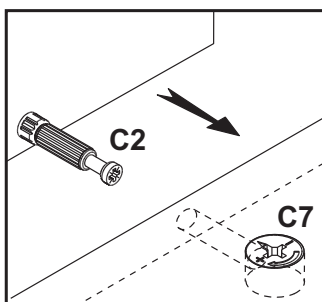
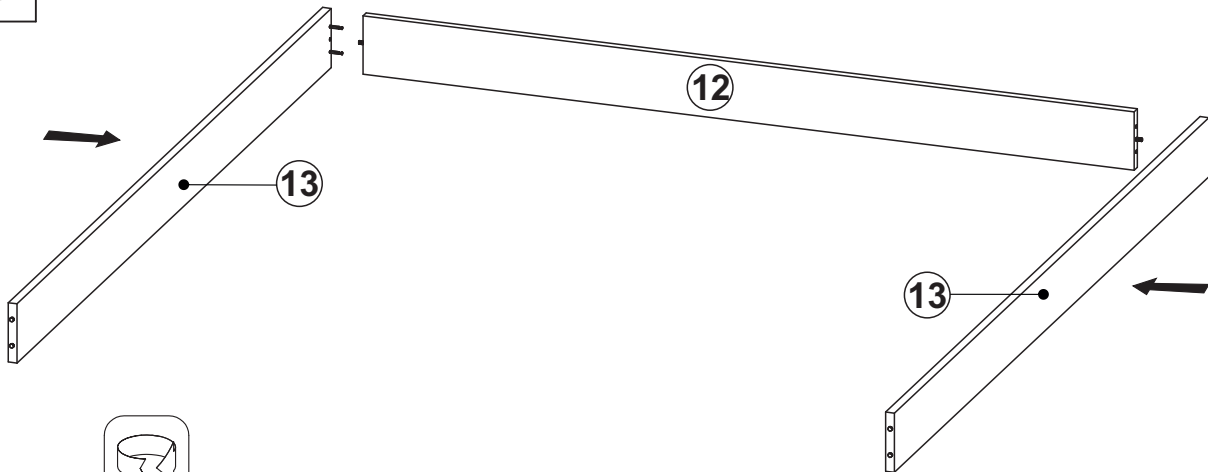

21

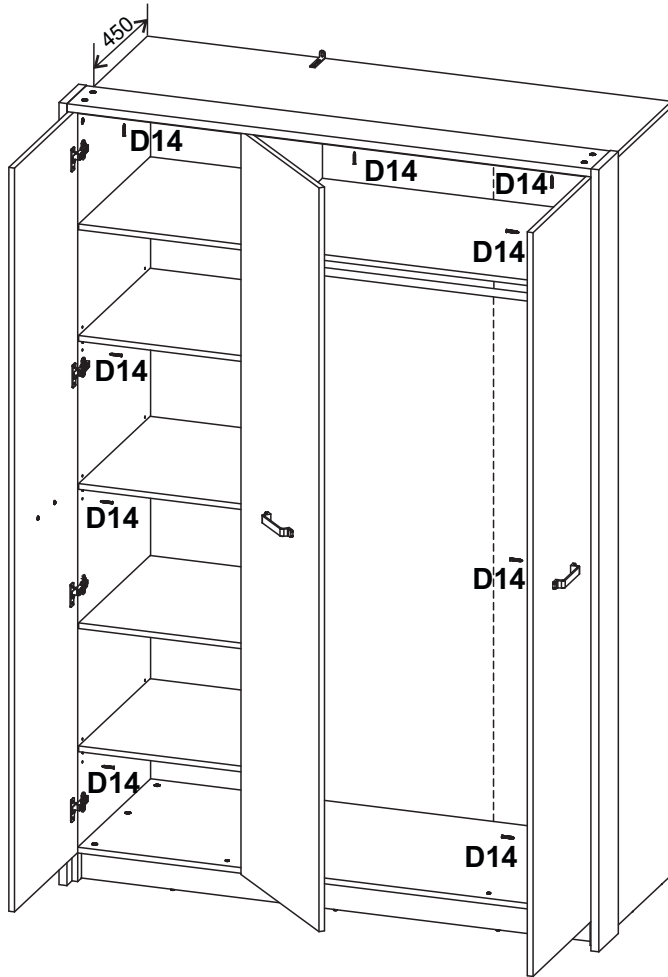

B0	C0	D14
x4	x16	x9

4x35

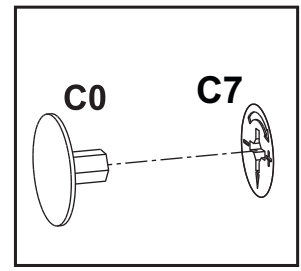
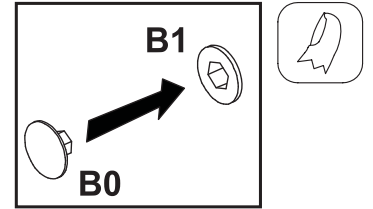

22

