

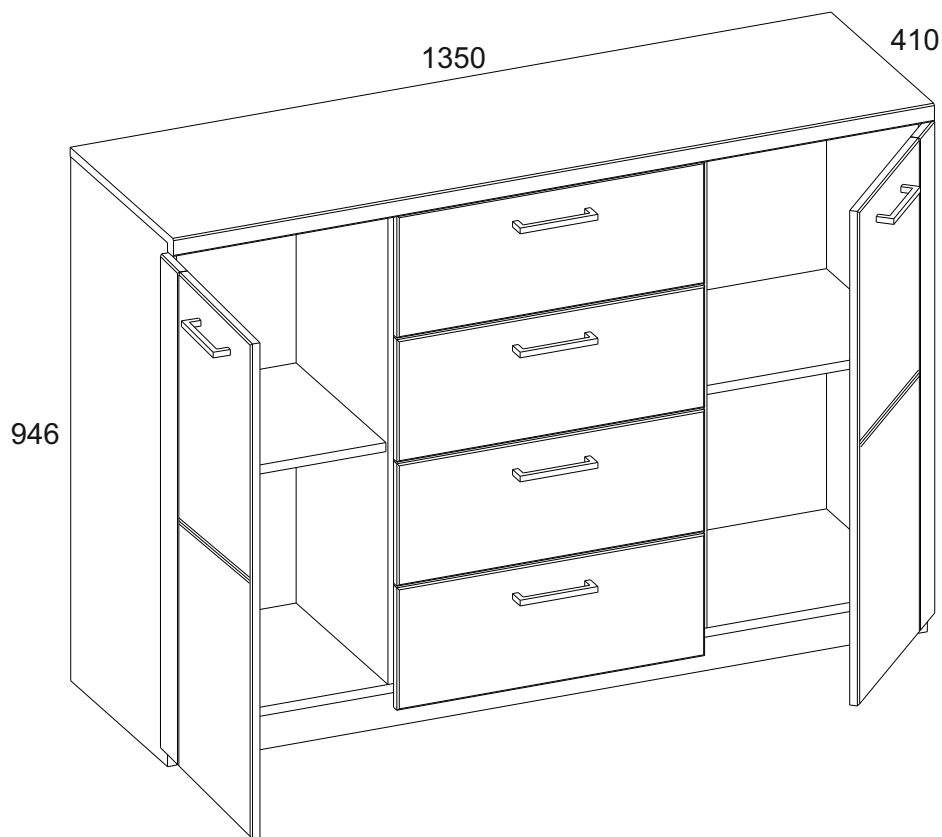

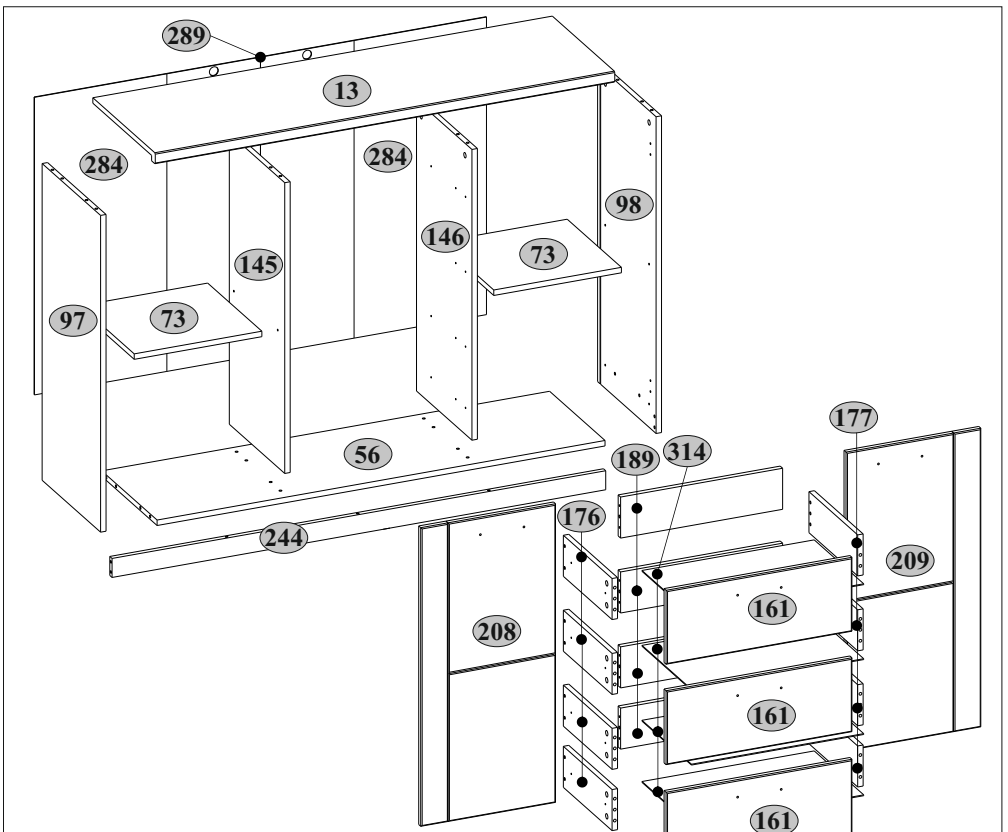









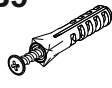
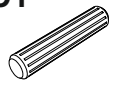
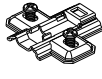
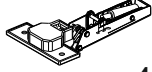





DORSI 2D4S

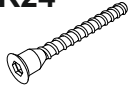

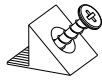
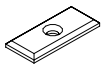

	L, mm	B, mm	H, mm	Q	
13	1350	410	32	1	2/2
56	1316	364	16	1	2/2
73	375	356	16	2	1/2
97	926	384	16	1	1/2
98	926	384	16	1	1/2
145	850	364	16	1	1/2
146	850	364	16	1	1/2
161	546	216	16	3	2/2
162	546	216	16	1	2/2
176	320	120	16	4	1/2
177	320	120	16	4	1/2
189	476	120	16	4	2/2
208	873	396	16	1	1/2
209	873	396	16	1	1/2
244	1316	60	16	1	2/2
284	872	389	2,5	2	1/2
289	872	550	2,5	1	1/2
314	506	325	2,5	4	2/2



A1  7x34 28	A2  Ø15x12 28	B5  10x50 2	C1  8x35 39
D1-1  4	E1-1  4	I  S4 1	H58  6
L1  320 4	N1  6	P5  8	R3  3x20 56
R23  6,3x13 8	R24  7x50 20	R27  5,0x13 40	R32  4x27 12
R102  3,5x16 20	S1  8	S3  8	S5  Ø18 20
U  130x35x15 2	Z10  300 4		

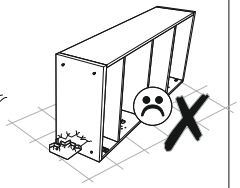
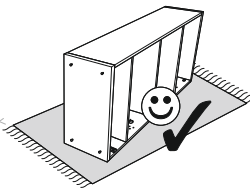
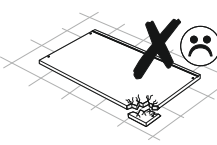
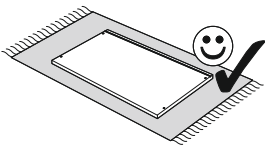
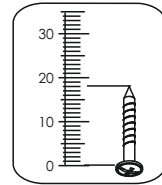
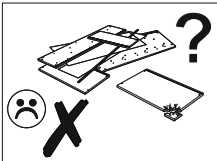
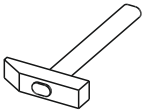
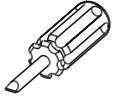
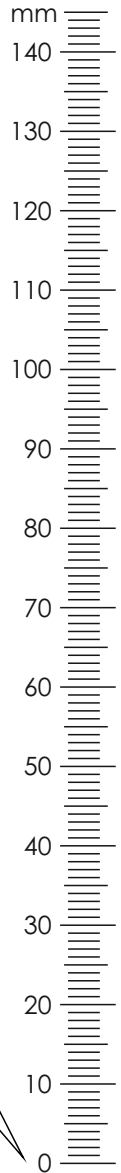

1

C1

8x35

P5

8

R27

4



5,0x13

Z10

24



300

4

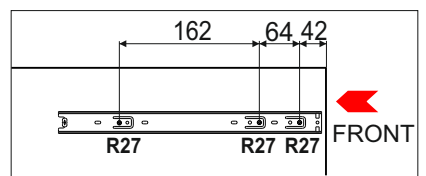
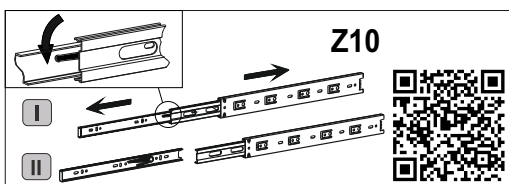
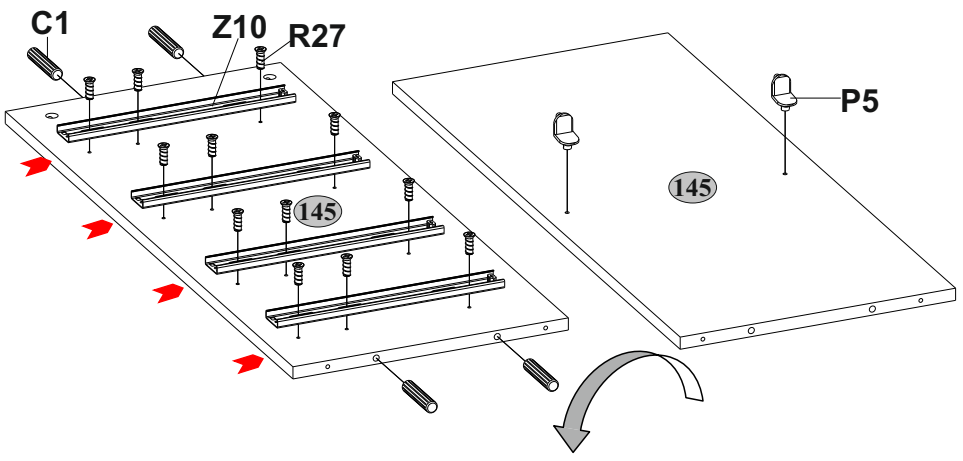
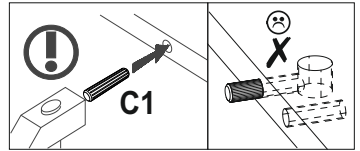
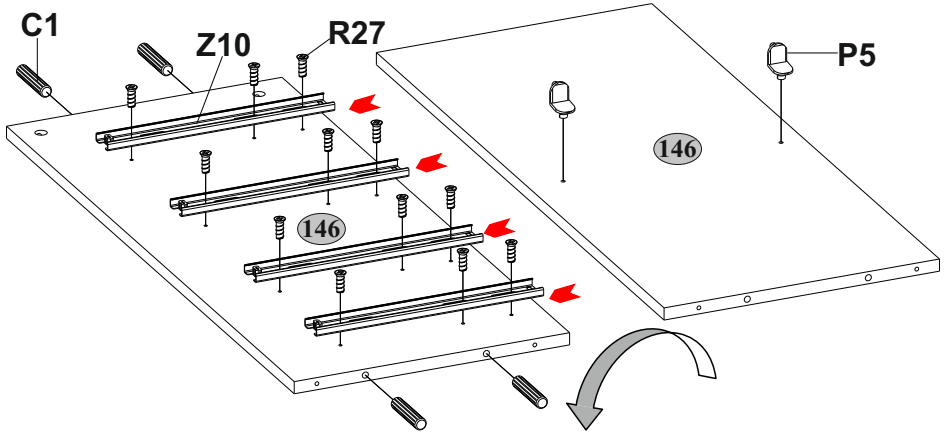

2

C1

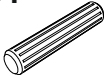

8x35

11

N1



2

C1

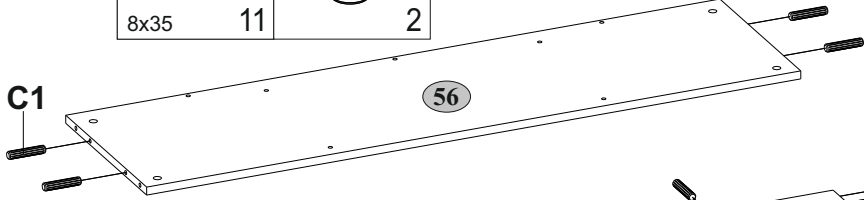

C1

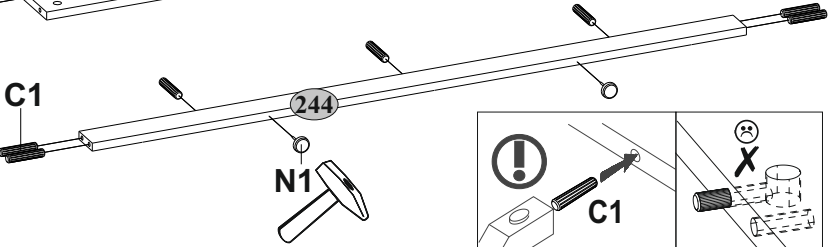

N1

244

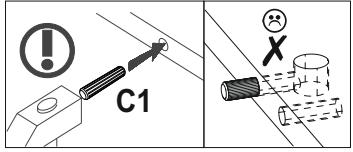

3

I



S4

1

R24

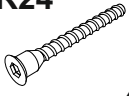

7x50

4

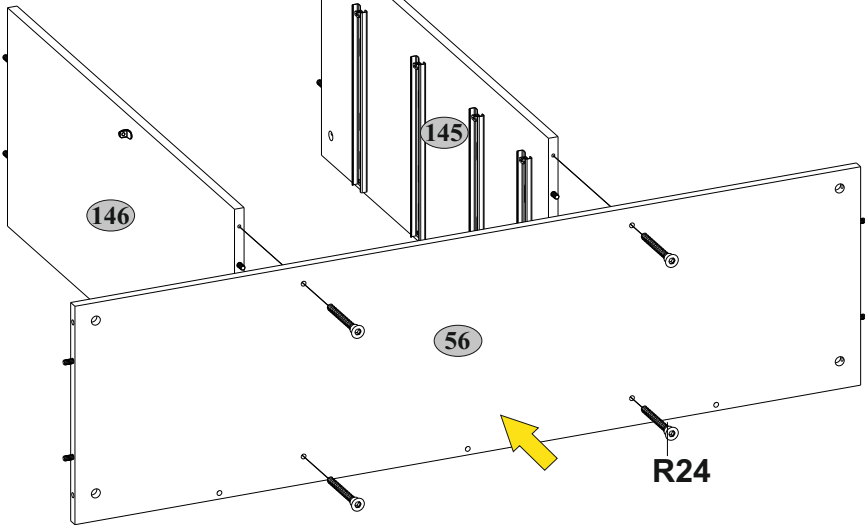
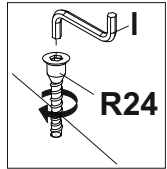

146

145

56

R24

4

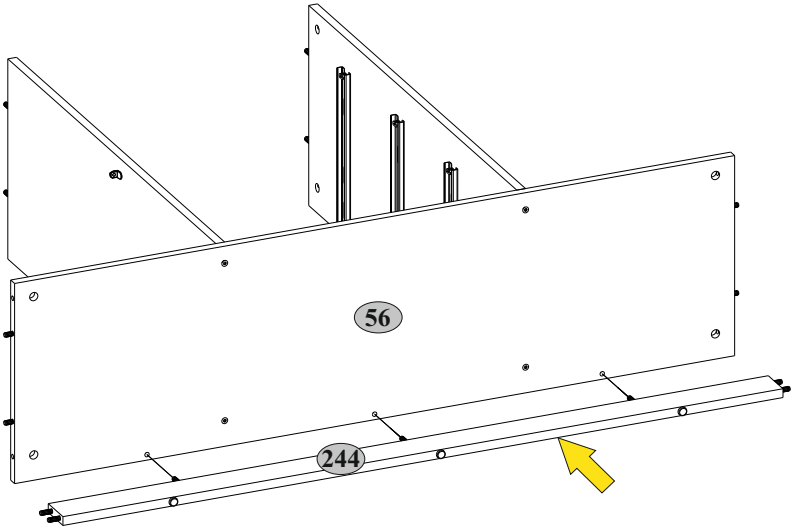

5

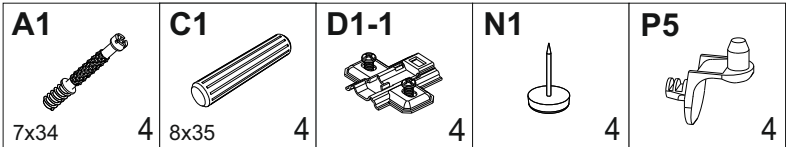

E1-1+D1-1

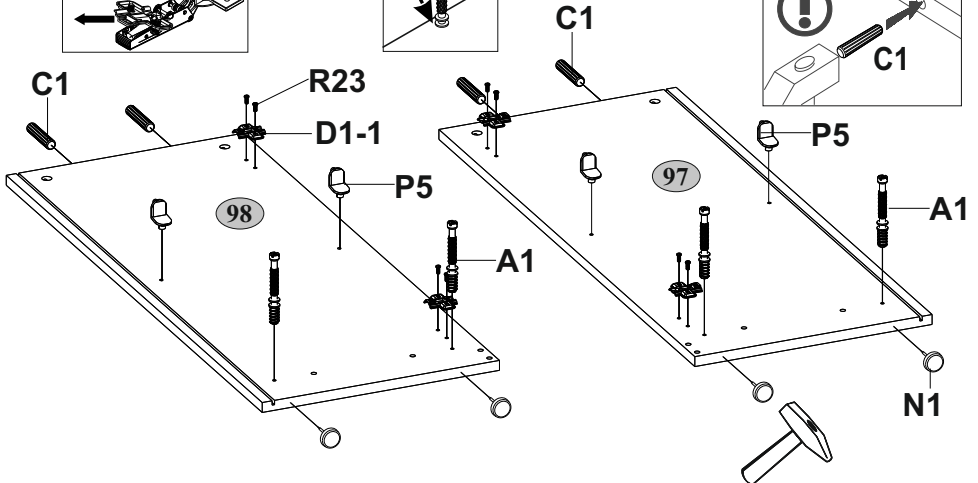
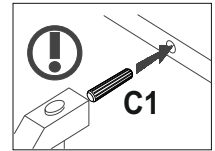
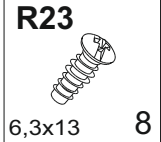
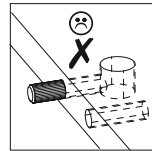
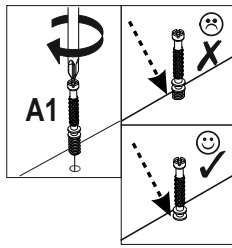
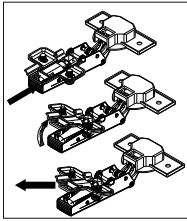

6

A2



Ø15x12

4

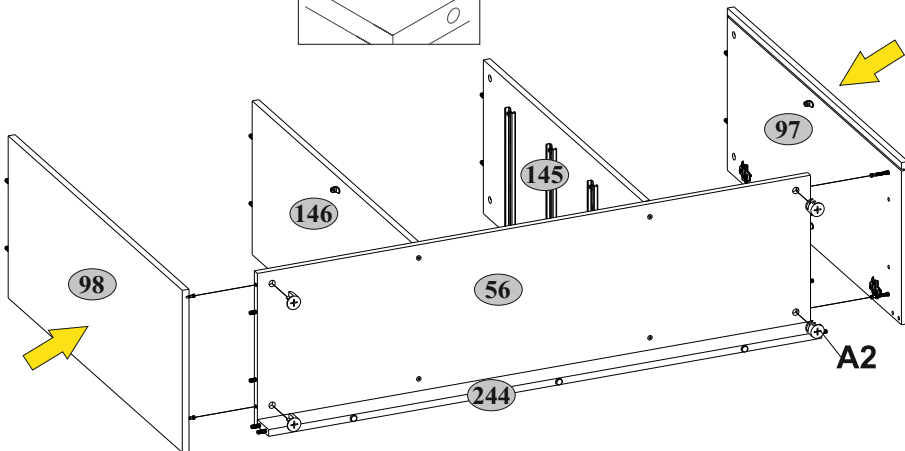
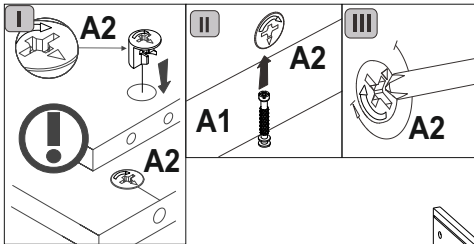

7

A1



7x34

8

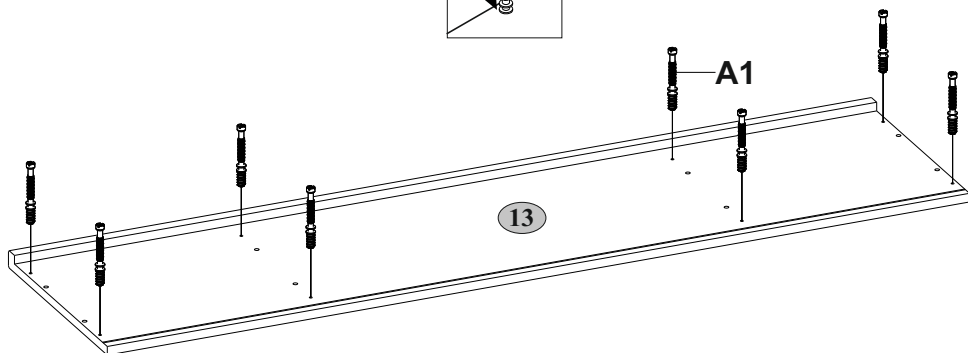
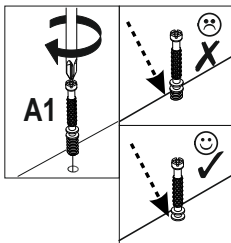

8

A2



Ø15x12

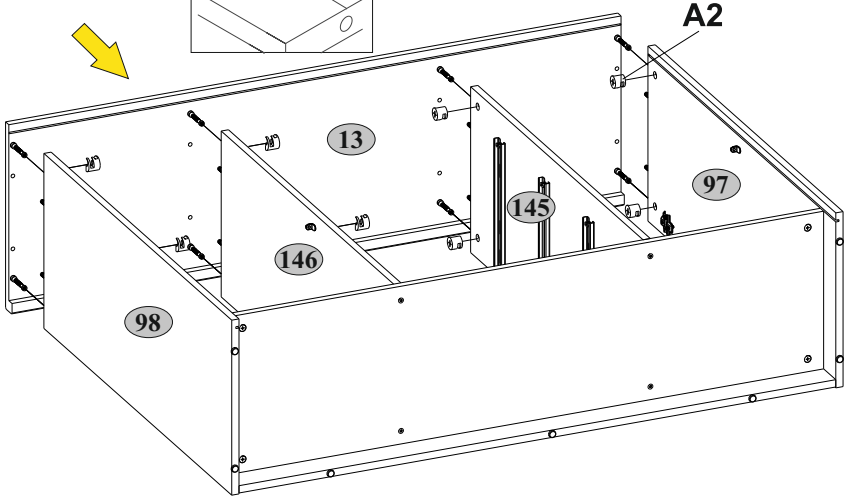
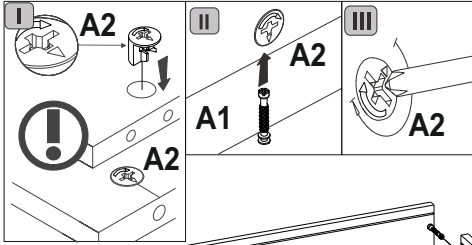

8

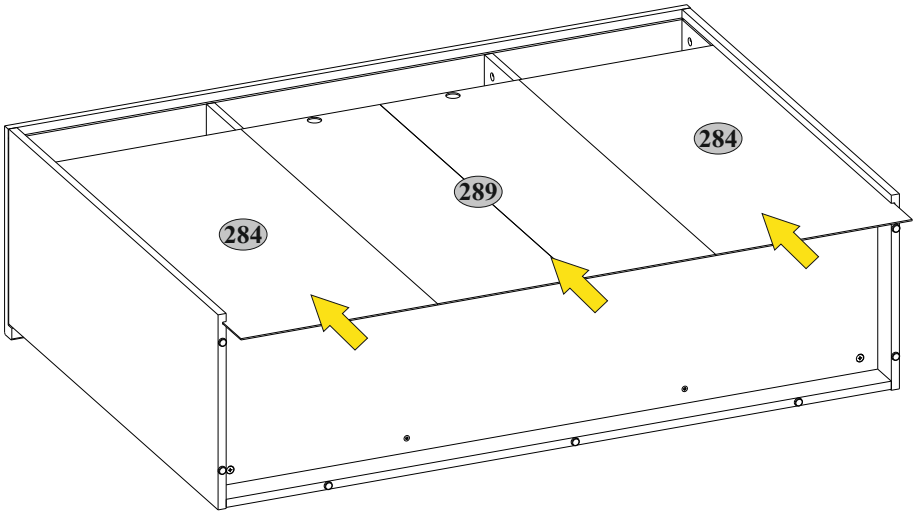

9





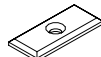

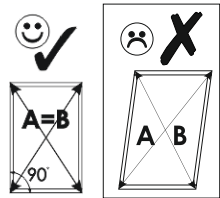
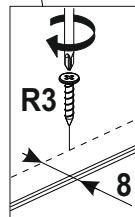
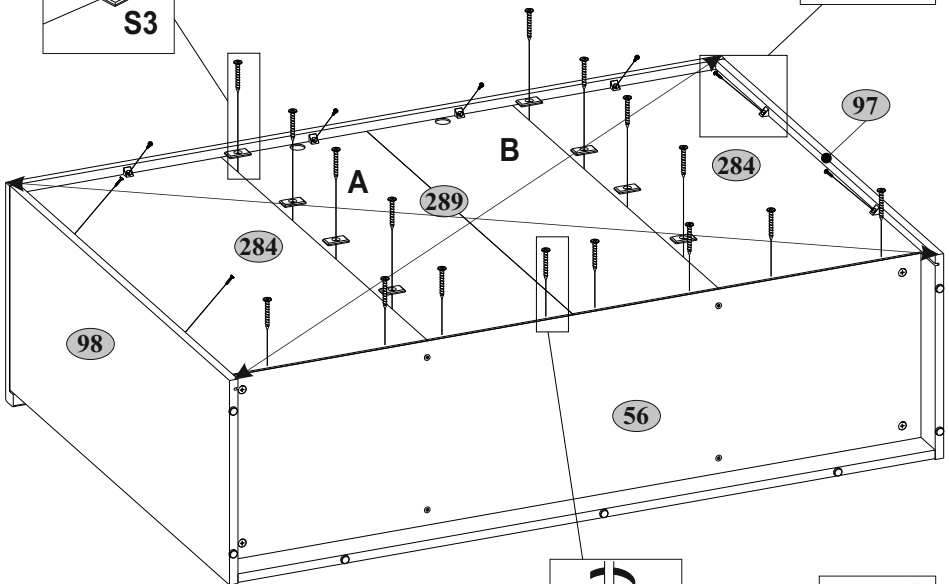
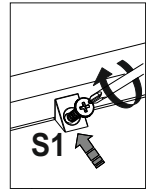
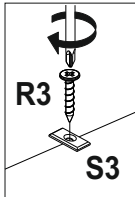



10

R3  3x20 16	S1  8	S3  8
--	---	---



11
x4

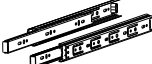

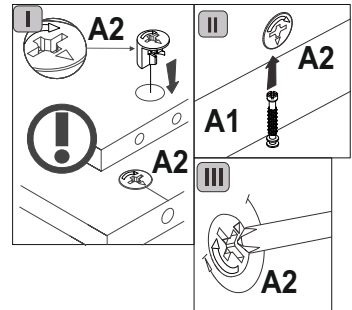
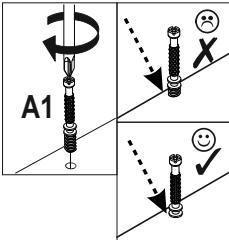
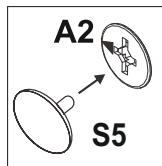
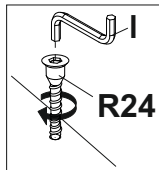
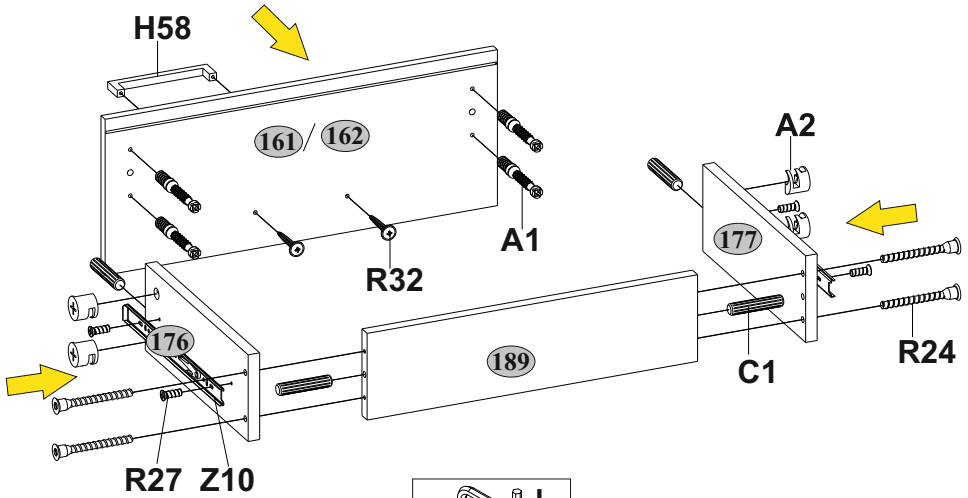
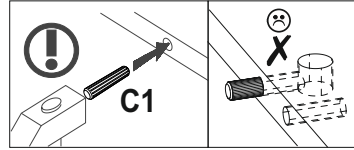
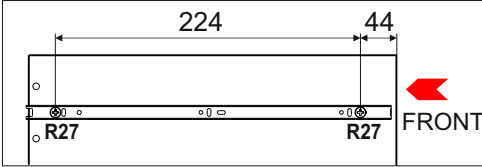
A1  7x34 16	A2  Ø15x12 16	C1  8x35 16	I  S4 1	H58  4
R24  7x50 16	R27  5,0x13 16	R32  4x27 8	S5  Ø18 16	Z10  300 4

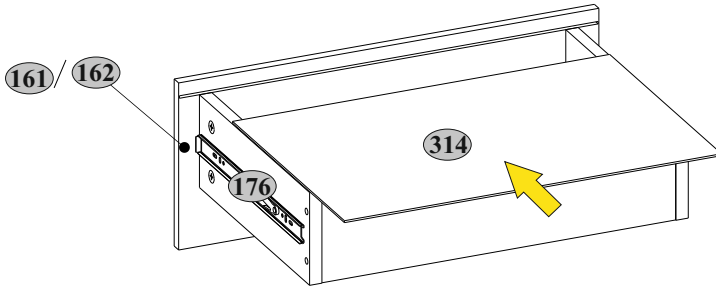

12
x4



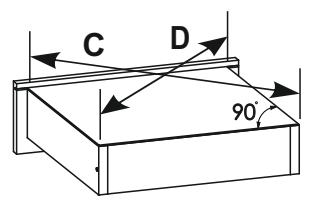
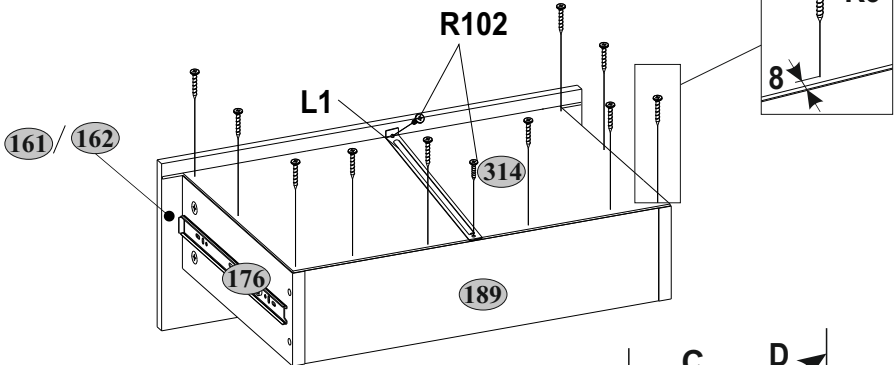

13
x4

L1  320	R3  4 3x20	R102  40 3,5x16
---	--	---

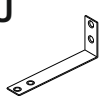

14

B5  10x50	R102  3,5x16	U  130x35x15
2	4	2

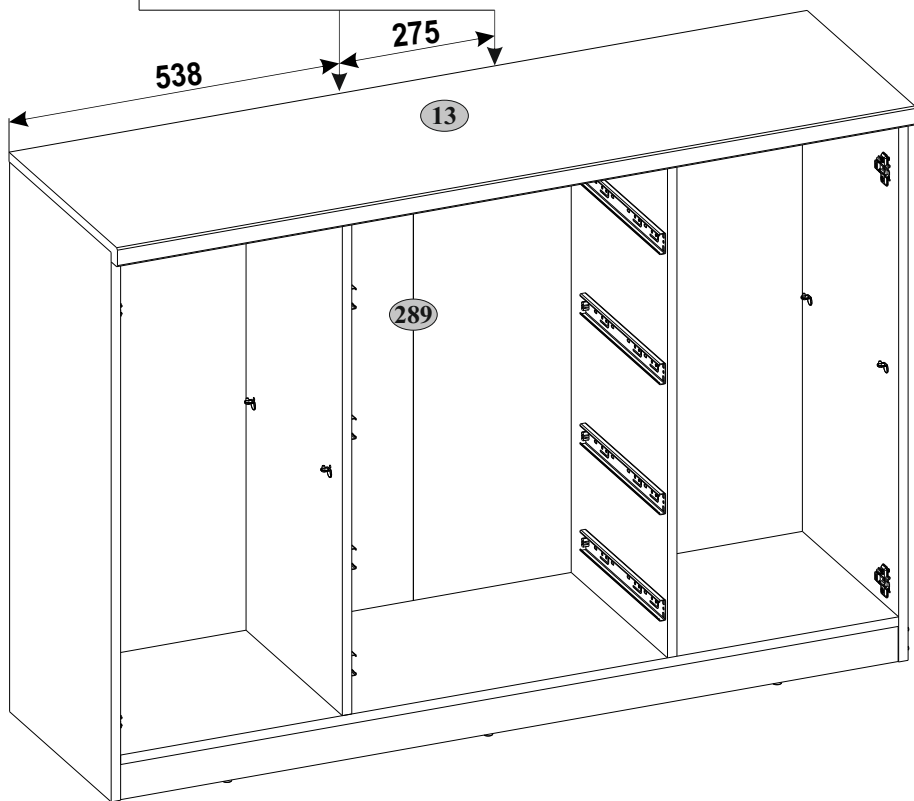
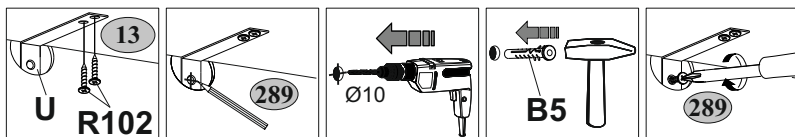
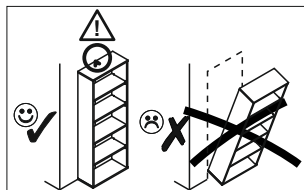

15

S5



Ø18

4

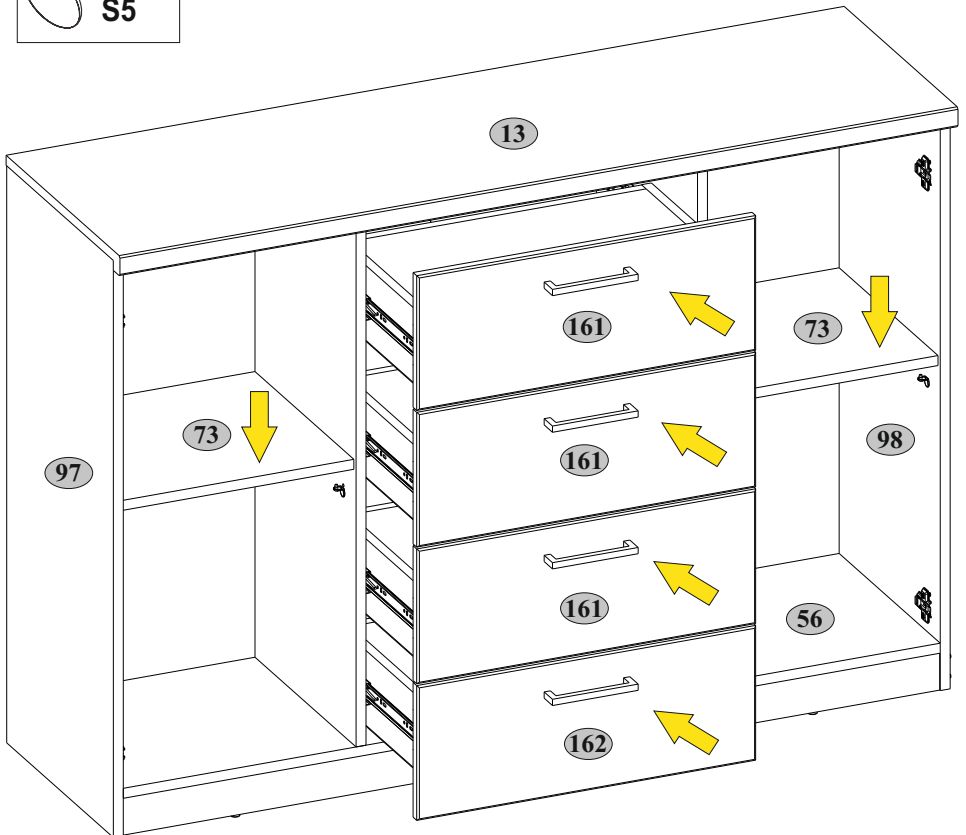
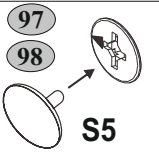

73 161 162  max. 5 kg

13 56  max. 10 kg

16

E1-1

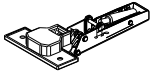

4

H58



2

R32



4x27

4

R102



3,5x16

8

R102

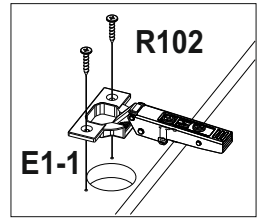

R102

E1-1

R102

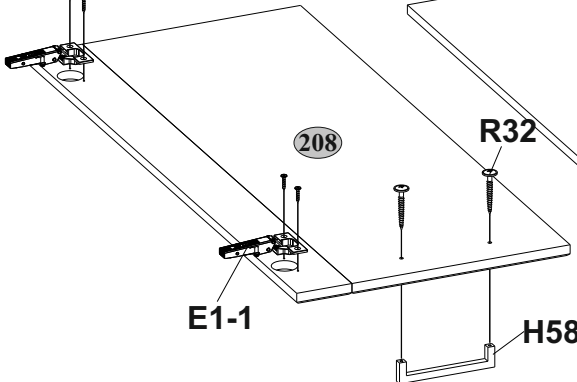

E1-1

208

R32

H58

209

E1-1

R32

H58

17

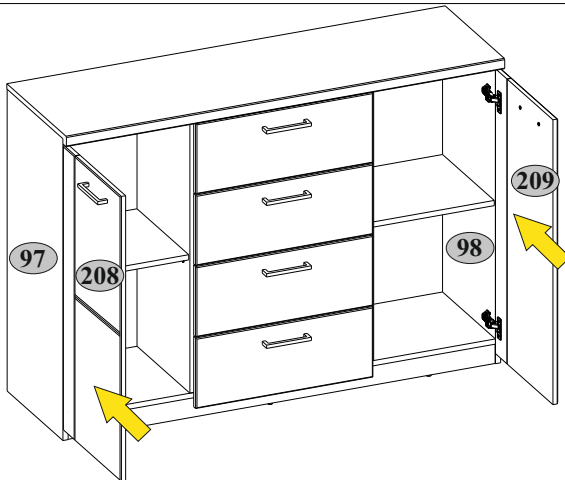

97

208

209

98

