

ESENA

2D1W

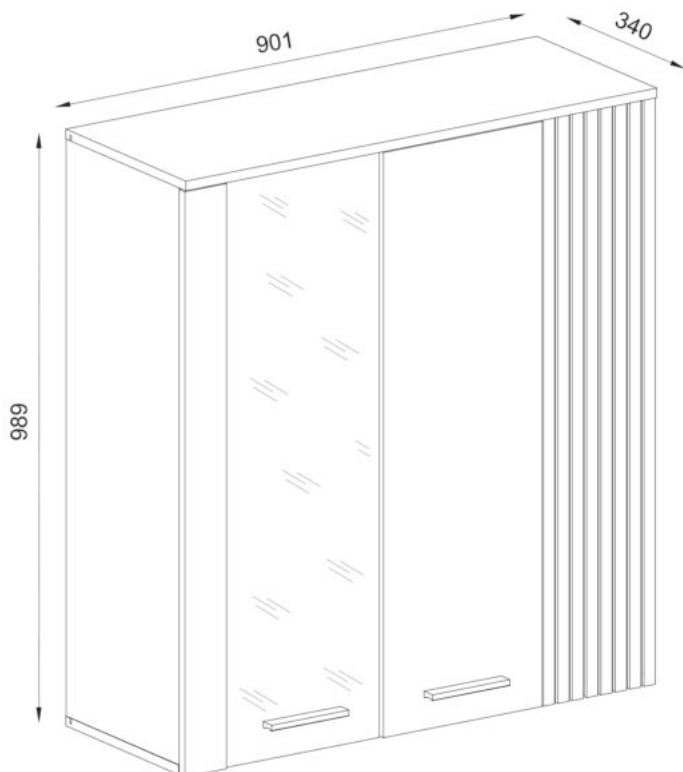

- pevne dotiahnut
- zatlačiť
- odmerať
- stlačiť
- zabiť
- otočiť - obrátiť

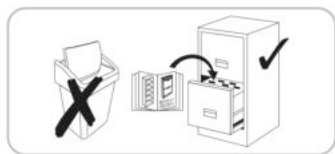
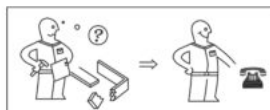
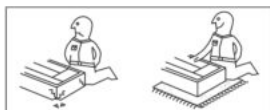
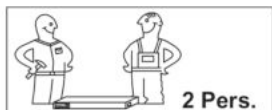
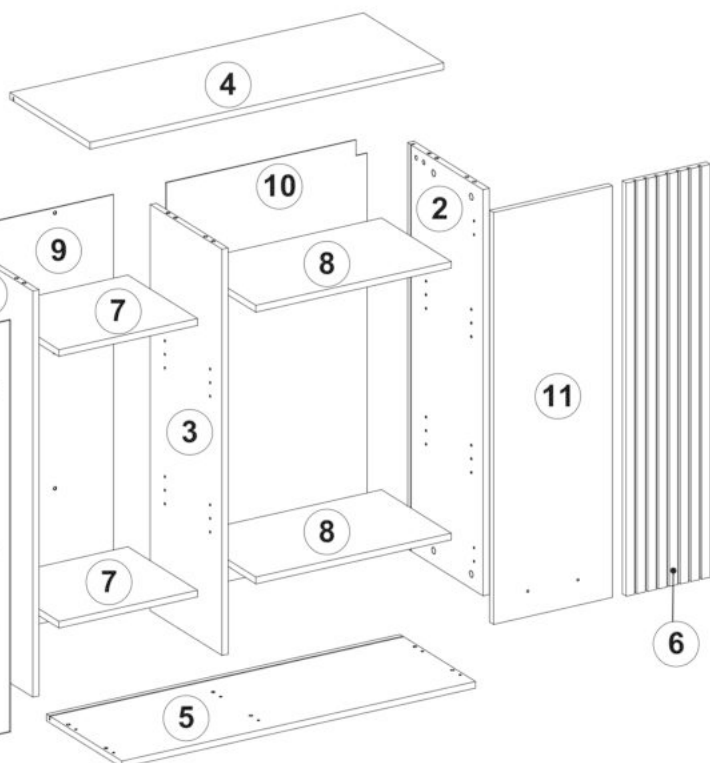





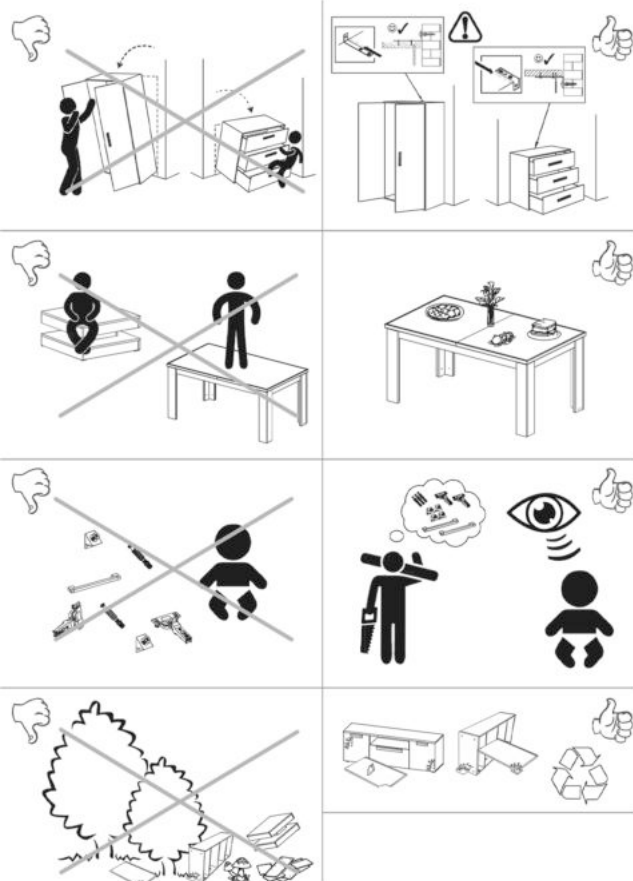











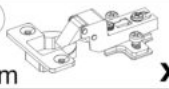



max. 10KG = 4 max. 5KG = 7 8

A	B (mm)	C	D
1	957 320	16 x1	2/2
2	957 320	16 x1	2/2
3	957 304	16 x1	2/2
4	901 340	16 x1	2/2
5	901 320	16 x1	1/2
6	970 214	16 x1	1/2
7	353 295	16 x2	2/2
8	498 295	16 x2	2/2
9	972 369	2,5 x1	1/2
10	972 512	2,5 x1	1/2
11	970 303	16 x1	1/2
12	970 376	16 x1	1/2
B1			1/2



B1 **1/2**

A1 15x12  x12	C2 44mm  x12	O1 ø18mm  x12
Y40 55mm  x2	D11 3,5x16  x12	D10 3x16  x4
B2 8x30  x12	N5 10x6x10  x2	K6 ø35mm  x4
K7 ø35mm  x2	J65 128/148  x2	R5 ø6mm  x4
DA21 4,2x16  x2	M1 10x10x15  x16	S4 20x10x2mm  x4
N1 ø6mm  x16	DB2 4x25  x2	D26 4x30  x4
Y2/R  x1	Y2/L  x1	Y39 10x50  x2

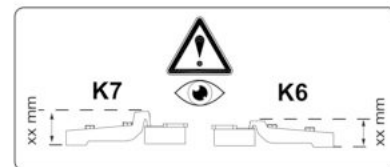

Náš nábytok sa musí používať podľa predpisov. Použitie v rozpore s predpismi môže viesť k vecným škodám a za istých okolností aj k zraneniam osôb. Nábytok nie je hračka. Za škody, ktoré vzniknú používaním proti predpisom alebo nesprávnou manipuláciou, nepreberá výrobca alebo predajca žiadnu záruku.

POZOR: Deti alebo osoby s mentálnym postihnutím sa musia neustále držať mimo častí nábytku, špicatých predmetov, drobných častí a obalových materiálov, pretože hrozí riziko zranenia a/alebo udusenía.

MONTÁŽ: Pri montáži dodržiavajte náš návod na používanie, obsluhu, inštaláciu alebo montáž a dávajte hlavne pozor na výstražné a bezpečnostné pokyny. Pokiaľ sa nebudú dodržiavať predpisy, môže to mať za následok zranenie osôb alebo poškodenie nábytku/ohrozenie bezpečnosti. Ak by ste mali problémy s inštaláciou/montážou, kontaktujte náš servisný tím. Ochoťne vám poradí a pomôže. Montáž smie vykonávať iba kvalifikovaný personál. Pri zmenách na produkte/dieloch produktu, pri výmene alebo použití dielov/spotrebných materiálov, ktoré nepochádzajú od výrobcu/predajcu, nepreberáme žiadnu zodpovednosť za škody.

Pokiaľ sú k tovaru priložené upevňovacie prvky na stenu, ako sú hmoždinky a skrutky, sú tieto určené výhradne na použitie na stenách z pevných a jednoliatych materiálov. Upevnenie je len tak dobré, ako dobré je spojenie medzi upevňovacím prostriedkom a stenou. Pred upevnením musíte skontrolovať vhodnosť vašej steny pre stojací aj zavesný nábytok a použiť iba vhodné spojovacie prvky. Pred prípadným vitaním sa uistite, že sa v oblasti vitania nenachádzajú elektrické vodiče. Nakoniec je za upevnenie na stenu zodpovedný inštalčný technik.

Platí to aj pre inštaláciu elektrických produktov a ďalšieho stavebno-technického príslušenstva. Montáž/inštaláciu elektrických produktov a tiež ďalšieho dôležitého konštrukčného príslušenstva môže vykonávať iba autorizovaný kvalifikovaný personál. Všetky elektrické a stavebno-technické inštalácie musia byť vykonané v súlade s platnými normami a bezpečnostnými predpismi vo vašej krajine. Pre svetelné zdroje používajte iba povolenú intenzitu osvetlenia. Pri nedodržaní max. počtu Watt hrozí riziko požiaru v dôsledku prehriatia. Prekrývanie svietidiel nie je povolené z dôvodu rizika požiaru. Dokonalá funkcia nábytku je zaručená iba pri vertikálnej a horizontálnej inštalácii. Dvere sú vopred nastavené, môžu sa ale znova nastaviť na základe miestnych podmienok. Dodržiavajte údaje o hmotnosti pre maximálne zaťaženie. Na nábytok sa nesmie liezť. Pri neodbornom použití môže dôjsť k prevráteniu nábytku. Aby sa tomu zabránilo, musí byť nábytok neustále zaistený proti prevráteniu. Pri preťažení/nadmernom preťažení (najmä hrajúcimi sa deťmi, ľuďmi, materiálom alebo inými nevhodnými vplyvmi) hrozí riziko rozbitia a zranenia. Všetky skrutky a nosné spojovacie miesta by mali byť dotiahnuté po 5 až 6 týždňoch, aby sa zaisťovala trvalá stabilita.

STAROSTLIVOSŤ: Pokyny pre starostlivosť o nábytok - Dodržiavajte naše pokyny pre správnu starostlivosť o nábytok, aby ste si náš výrobok mohli užívať čo najdlhšie. Pri čistení používajte čistú, suchú a mäkkú bavlnenú handričku. Pokiaľ potrebuje váš nábytok dôkladné vyčistenie, môžete handričku navlhčiť trochu vody alebo čistiaceho prostriedku na nábytok a potom vyčistené diely vysušiť. Kovové a sklenené diely sa najlepšie čistia bežne dostupnými čistiacimi prostriedkami na kov a sklo podľa pokynov uvedených na výrobku. Na čistiacich prostriedkoch musí byť jasne uvedené, že sú vhodné na čistenie nábytku. V žiadnom prípade nepoužívajte pemé čističe, žieraviny, abrazíva alebo iné prostriedky, ktorých účinky nepoznáte. **POZOR:** Vysoko lesklé povrchy sú pri dodávke chránené ochrannou fóliou. Nechajte fóliu na nábytku, kým nebude úplne zmontovaný a zbavený prachu. Vysoko lesklé prvky, z ktorých bola odstránená ochranná fólia, je možné čistiť a používať až po 72 hodinách (doba pre následné vytvrdenie na okolitom vzduchu).

Povrchy nemožno poškodiť ostrými predmetmi a nikdy ich nemôžete vystavovať silnému slnečnému žiareniu.





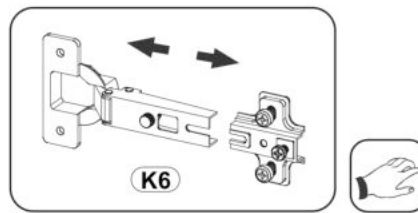
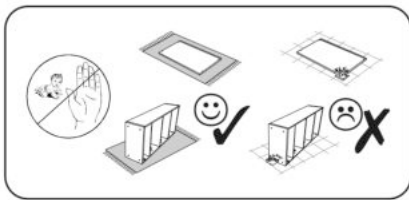

LIKVIDÁCIA

- Pokyny na likvidáciu odpadu -

V záujme ochrany životného prostredia vyhadzujte obalový odpad roztriedený podľa druhu do určených odpadkových/recyklačných nádob, v žiadnom prípade nevyhadzujte do prírody. Poškodený alebo nepoužiteľný nábytok je možné odoslať do špeciálnych zberných zariadení na recykláciu jednotlivých dielov. Použitý, ale stále funkčný nábytok nie je nutné hneď likvidovať. Darujte ho napr. charitatívnym organizáciám.

Prajeme vám veľa zábavy s vašim novým nábytkom.

1

B2		x8
8x30		
A1		x8
15x12		
K6		x4
ø35mm		
Y2/R		x1
Y2/L		x1
D26		x4
4x30		

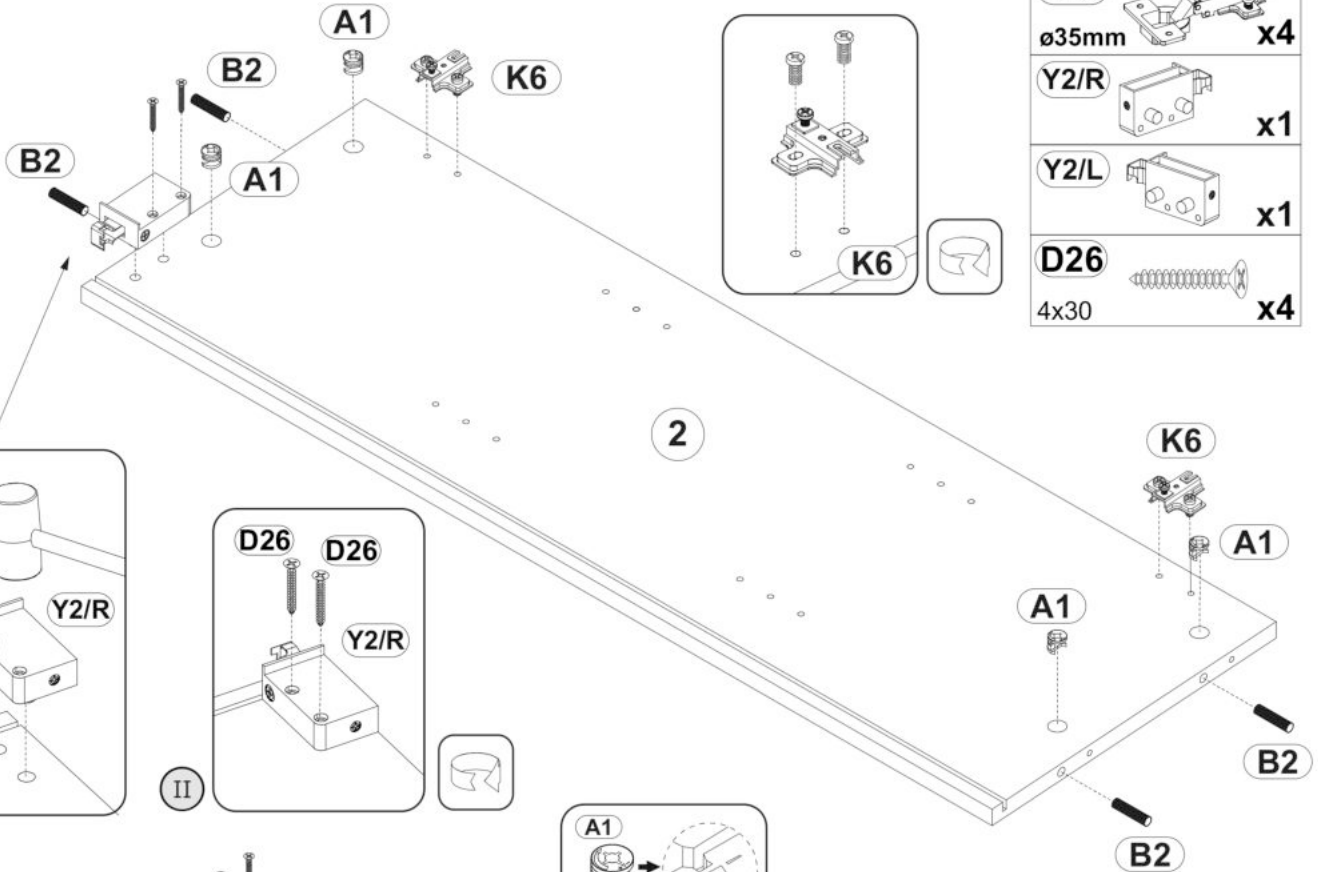

I

II

1

2

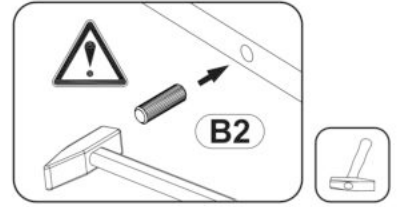
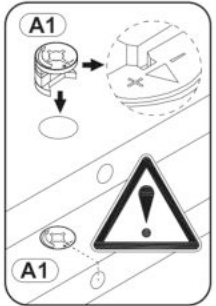

I

II

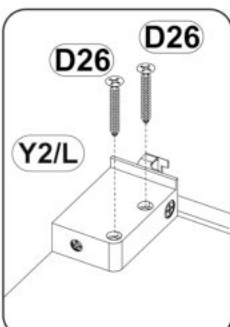
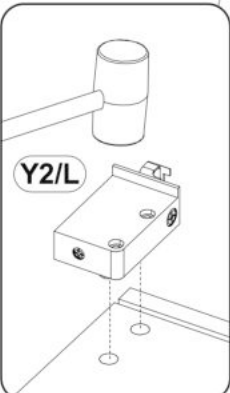

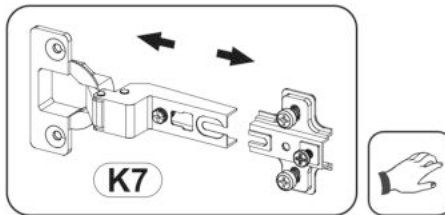
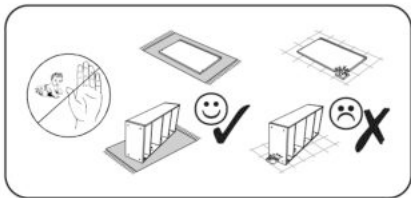

B2		x4
A1		x4
C2		x12
K7		x2

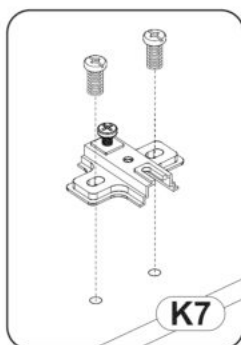
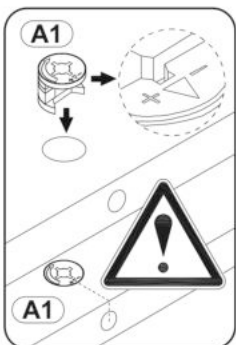
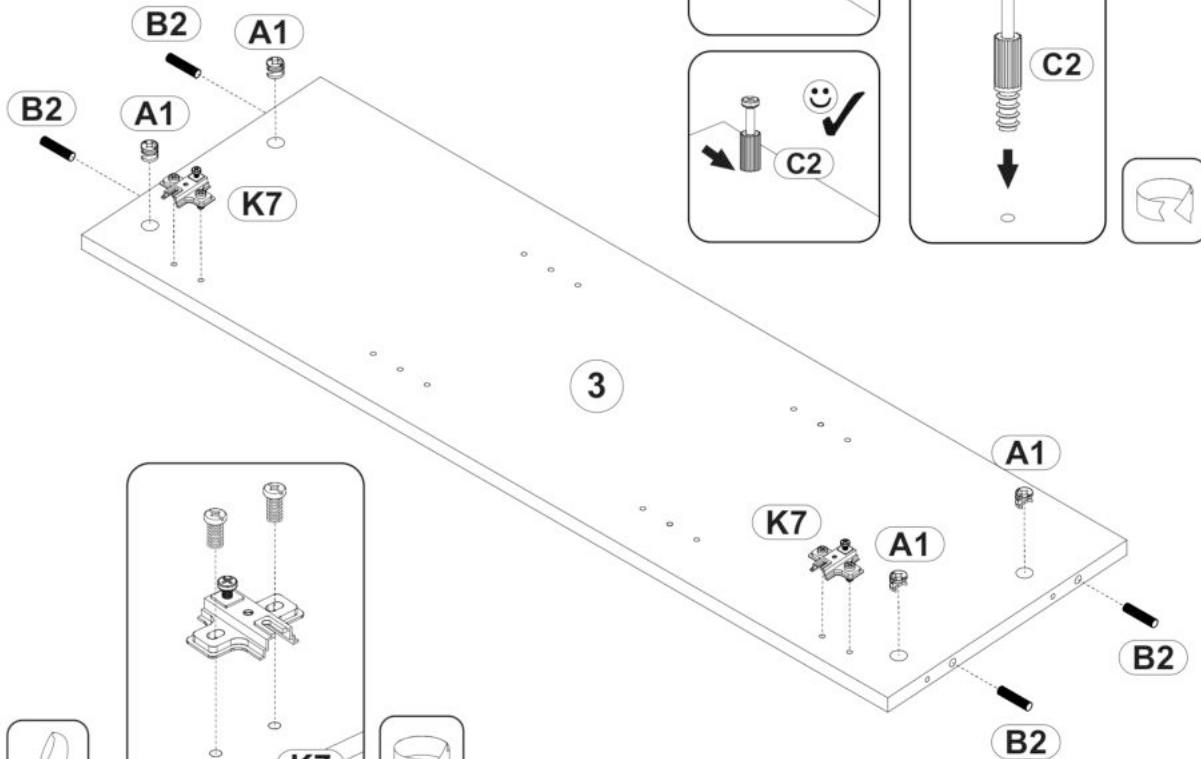
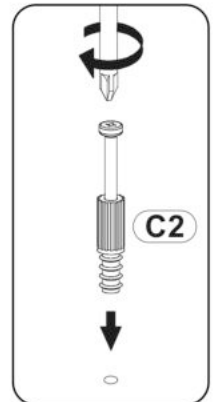
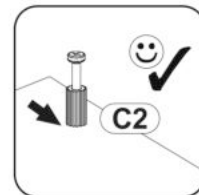
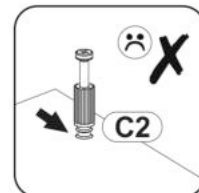
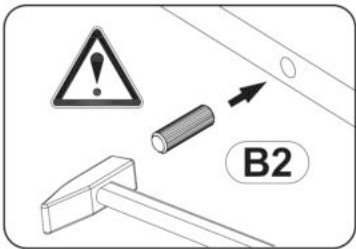
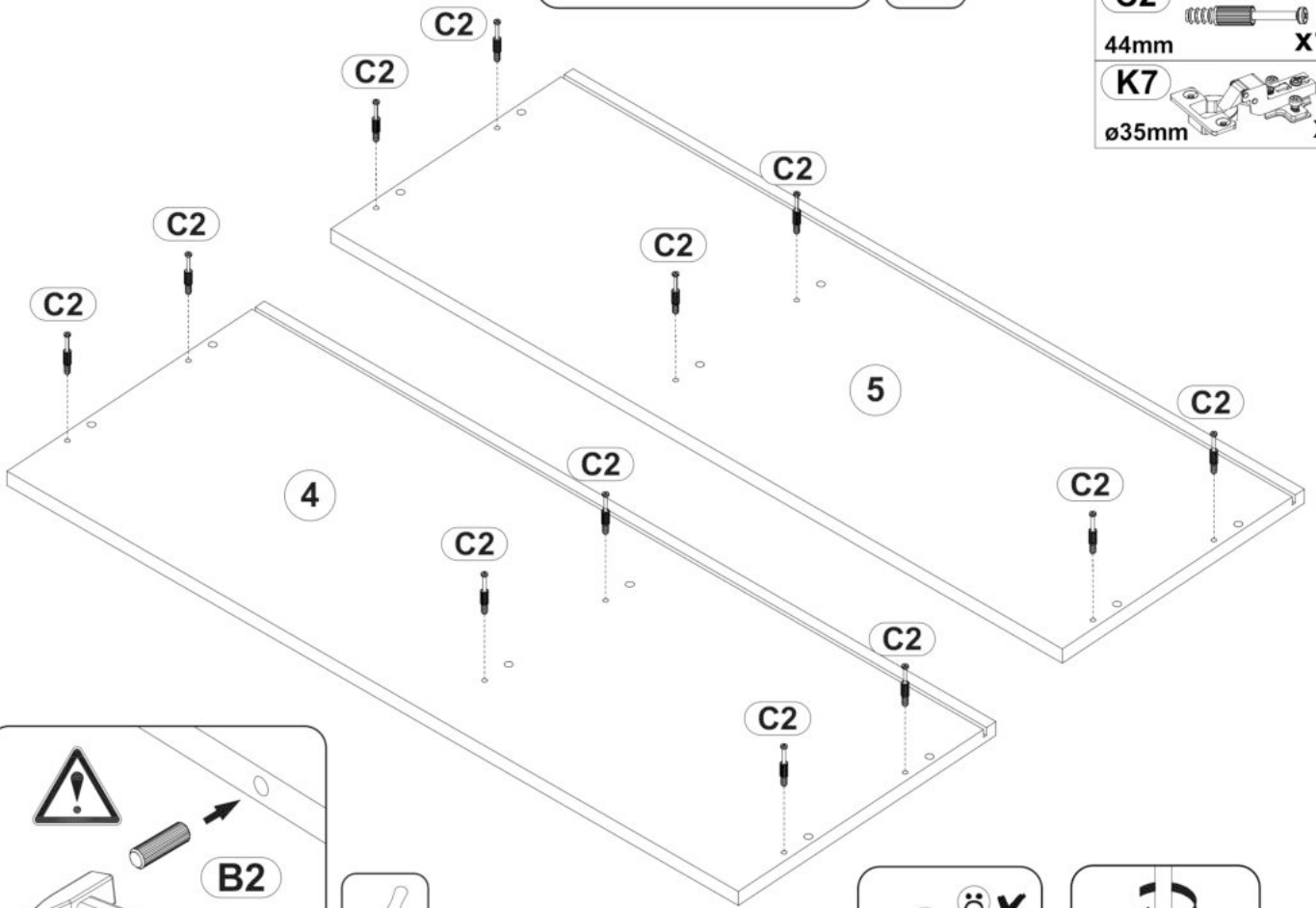

3

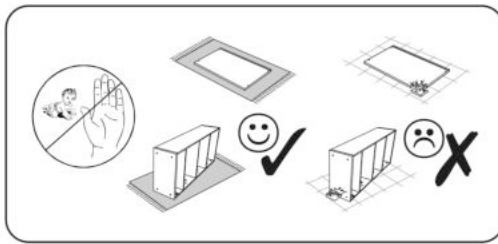

O1
ø18mm x6

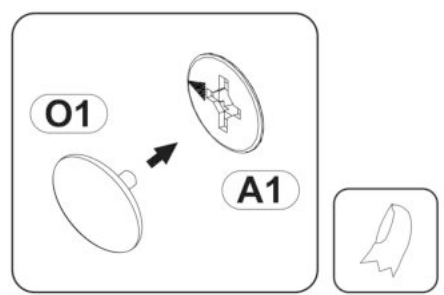
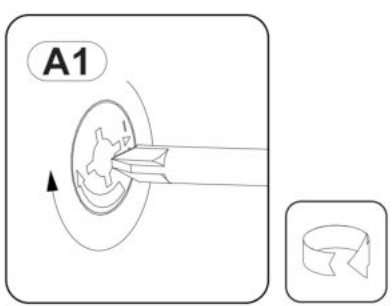
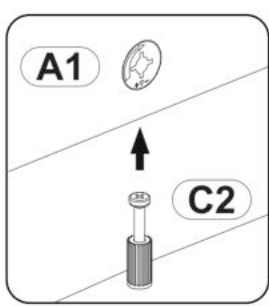
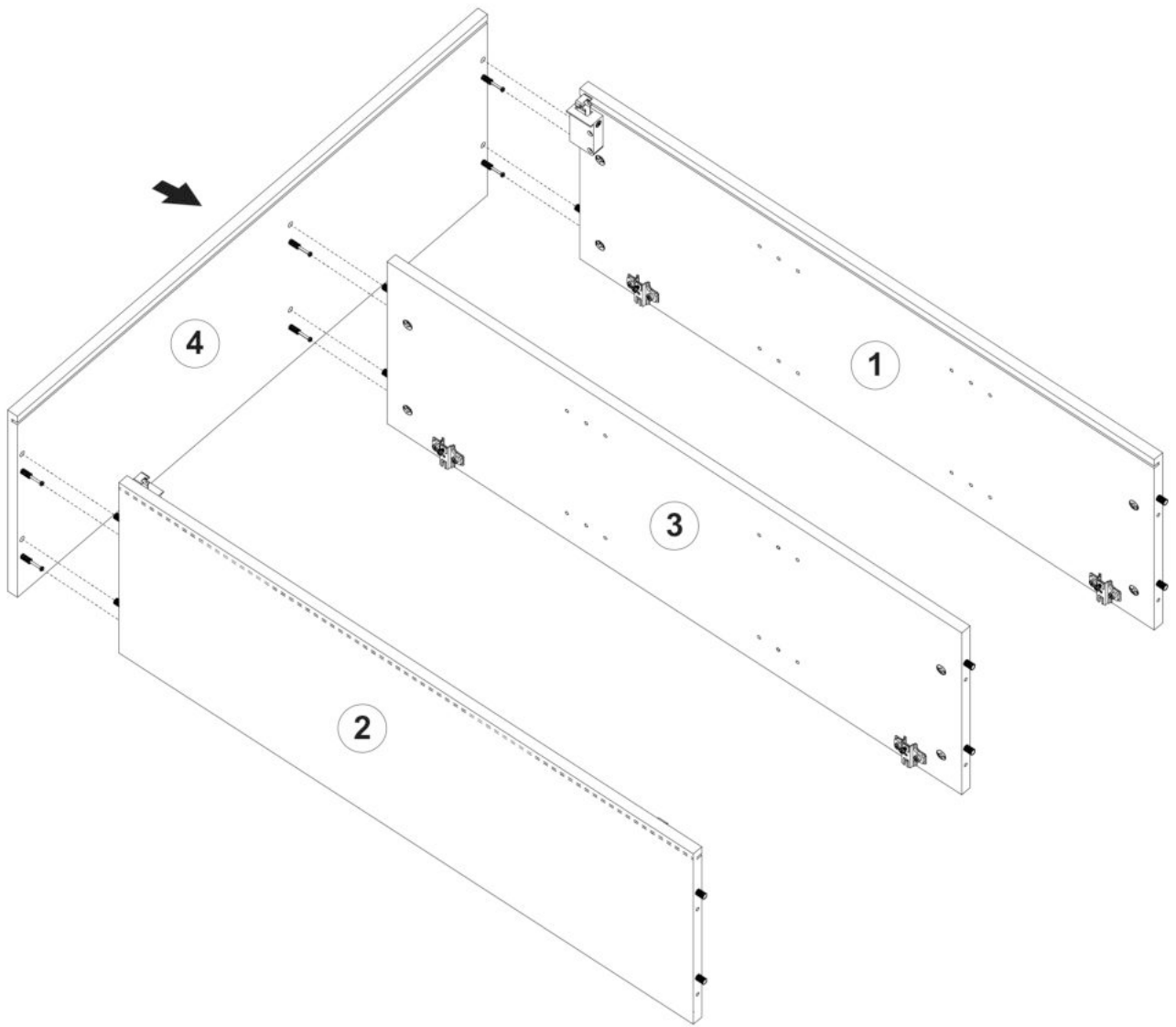

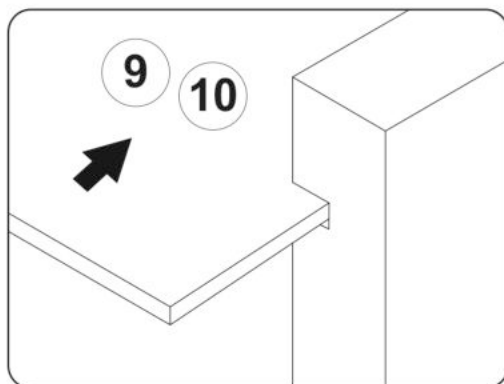
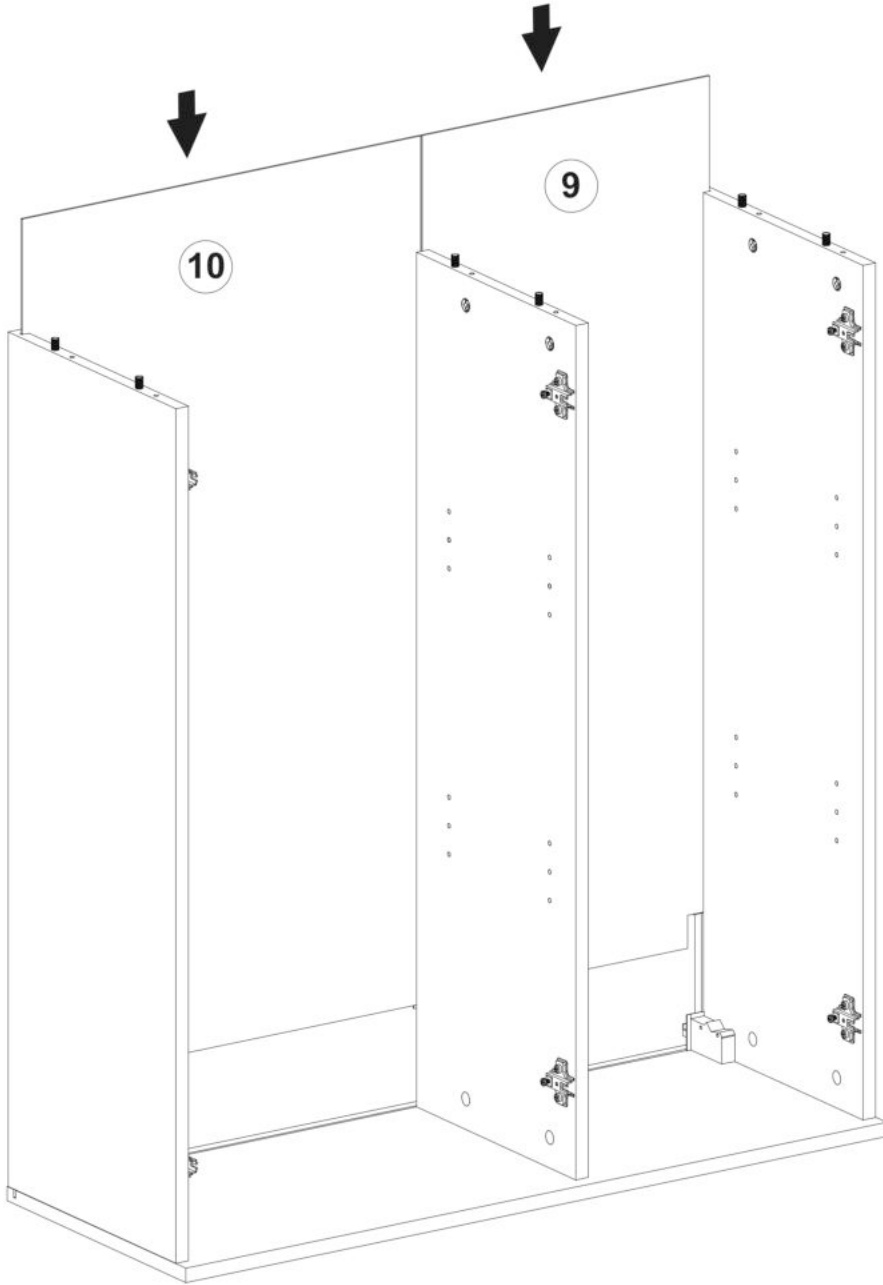

5

O1
ø18mm x6

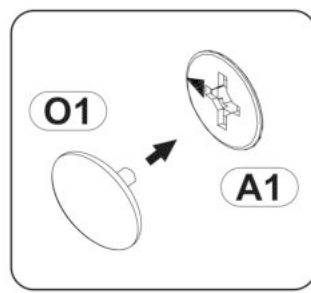
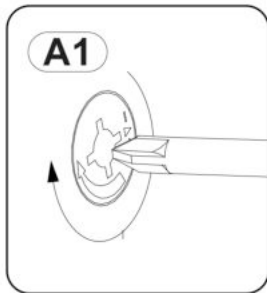
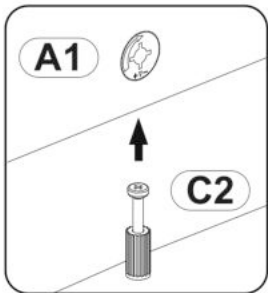
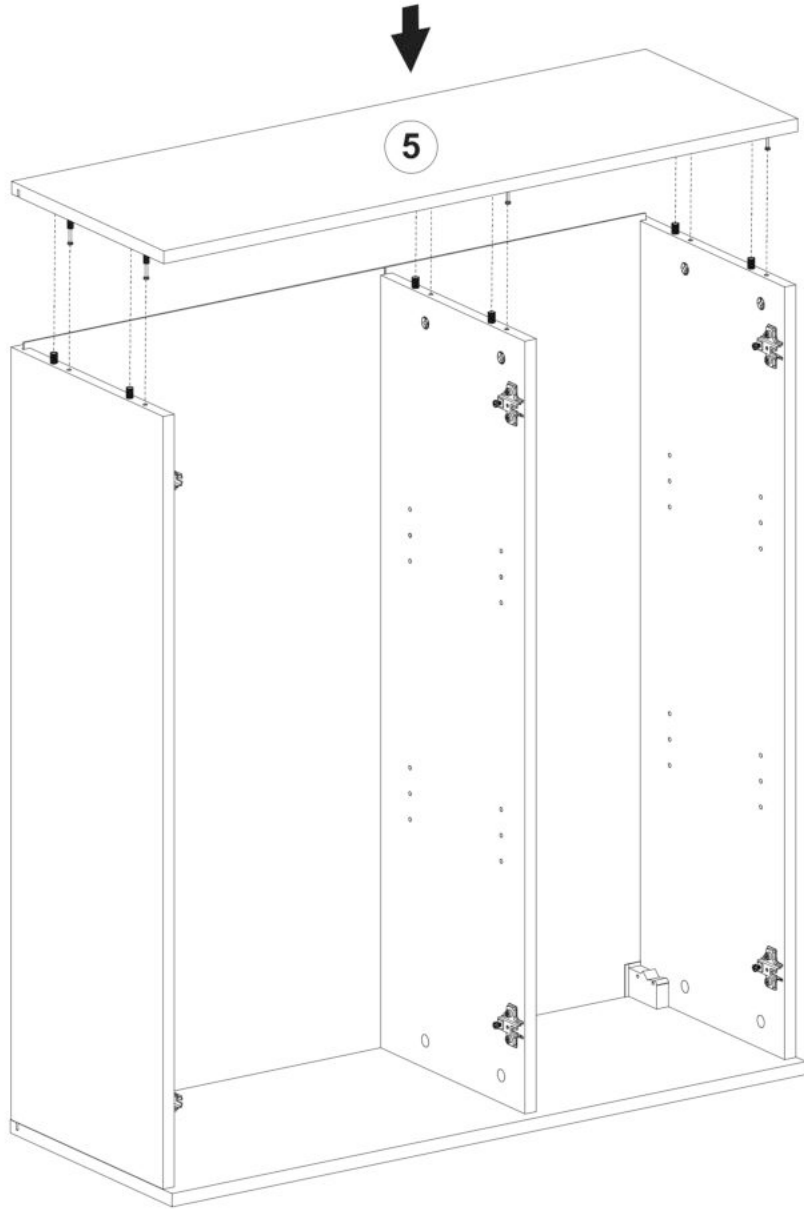

6

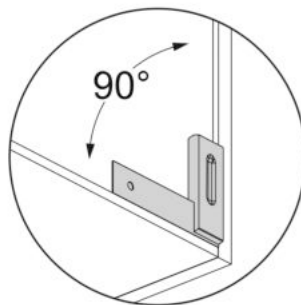
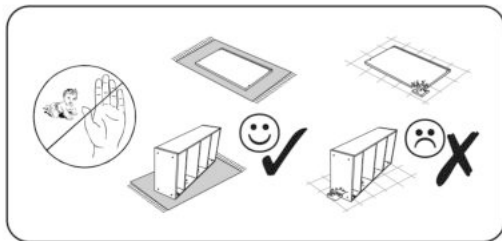

M1		x16
10x10x15		
S4		x4
20x10x2mm		
D10		x4
3x16		

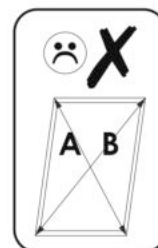
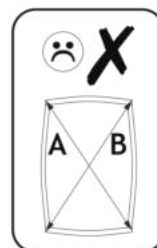
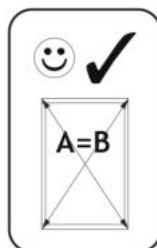
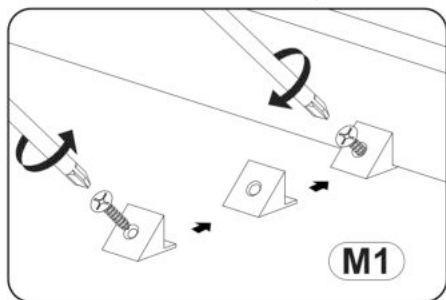
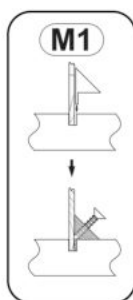
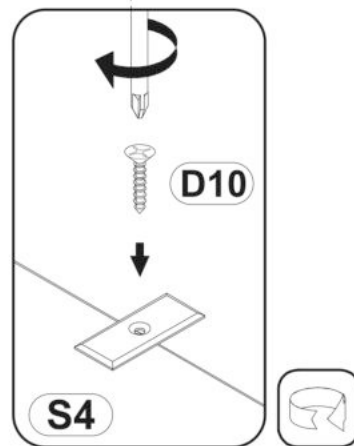
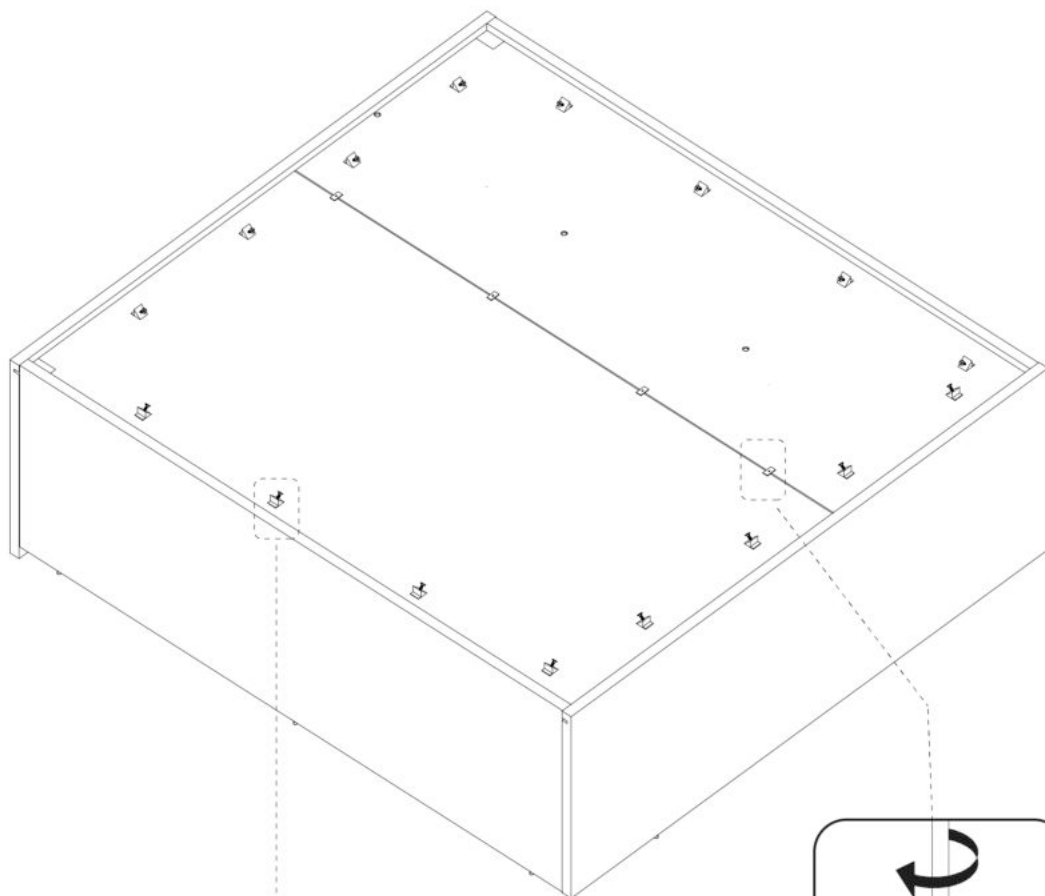

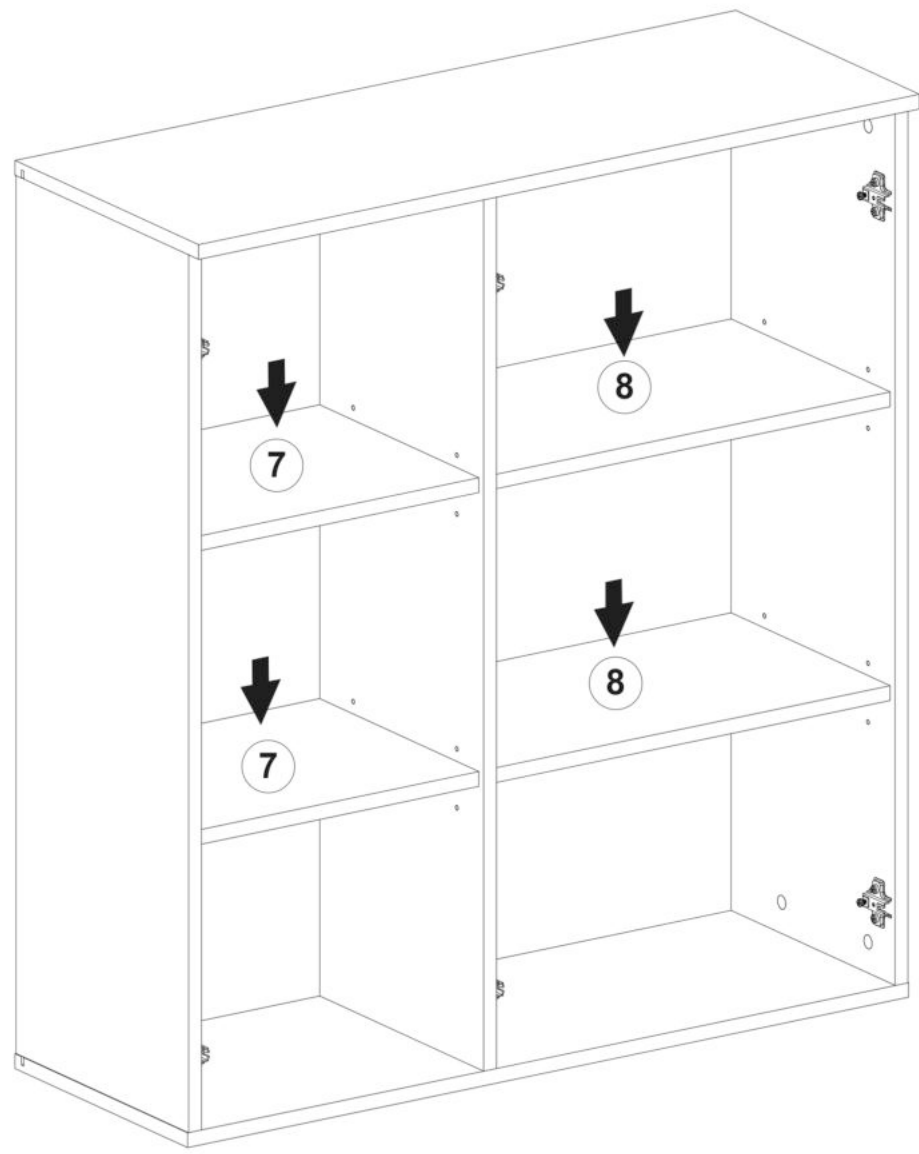

I

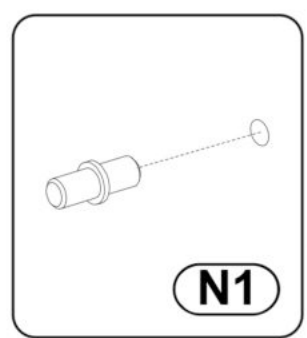

II

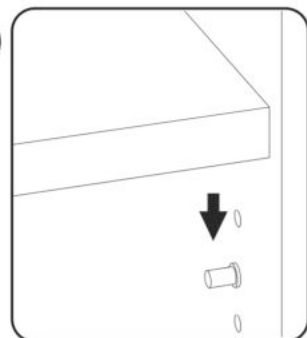

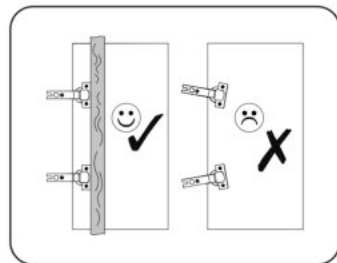
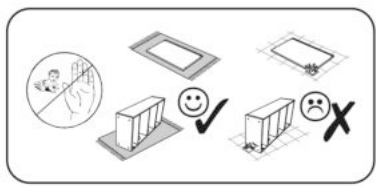

K6		x4
D11		x8
J65		x1
DA21		x2
R5		x3
N5		x2

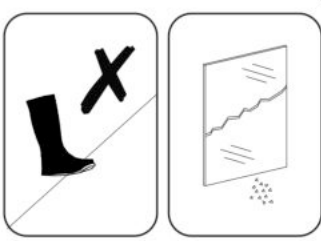
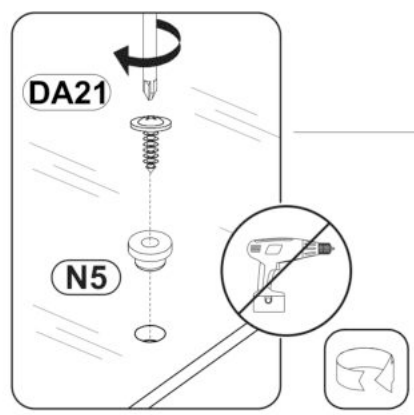
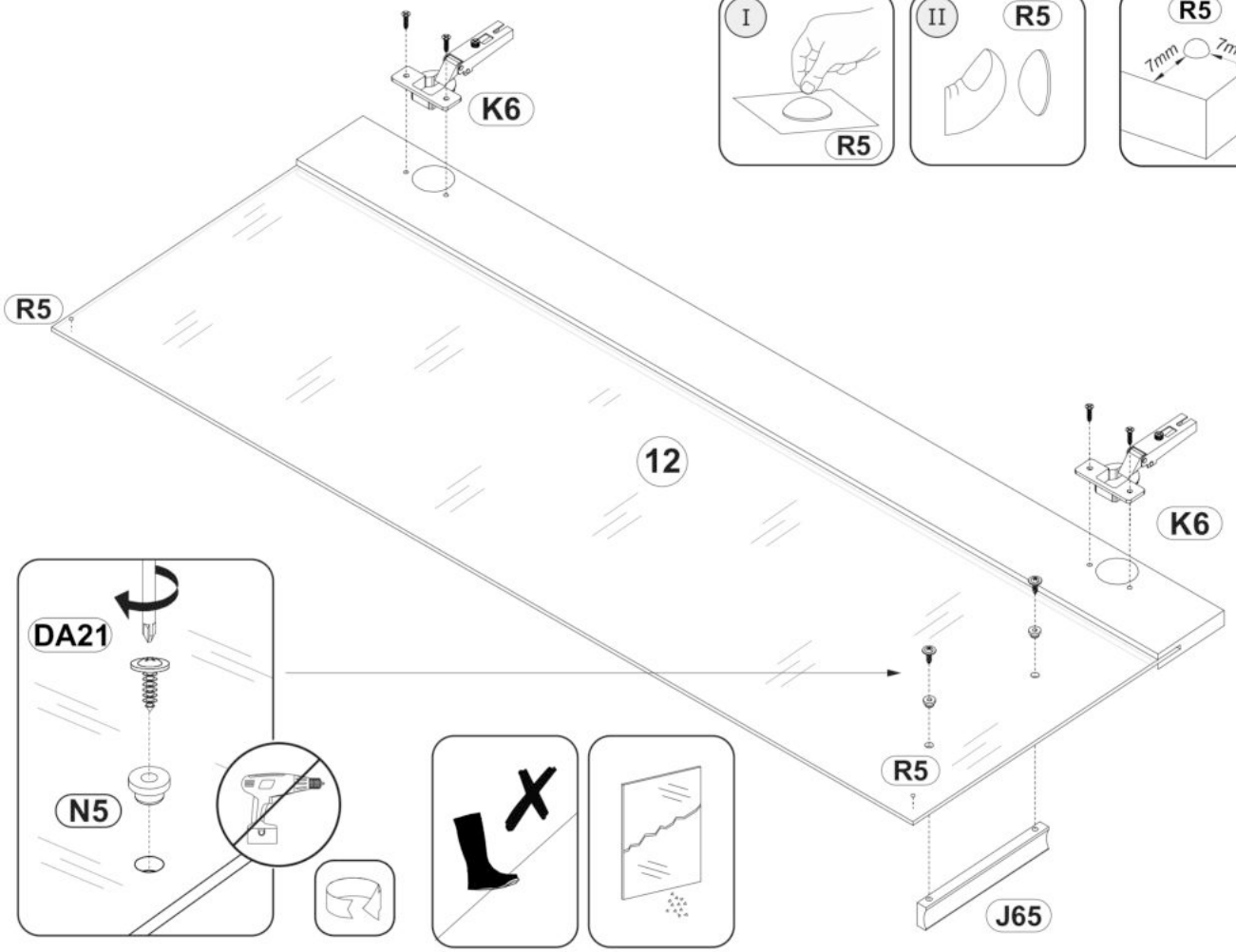
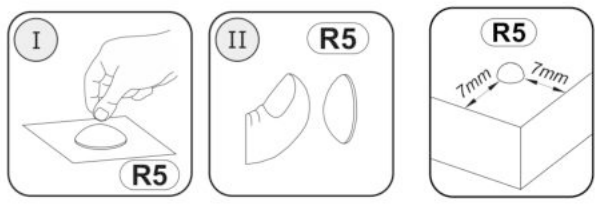
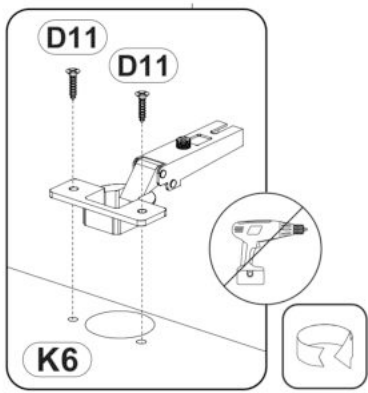
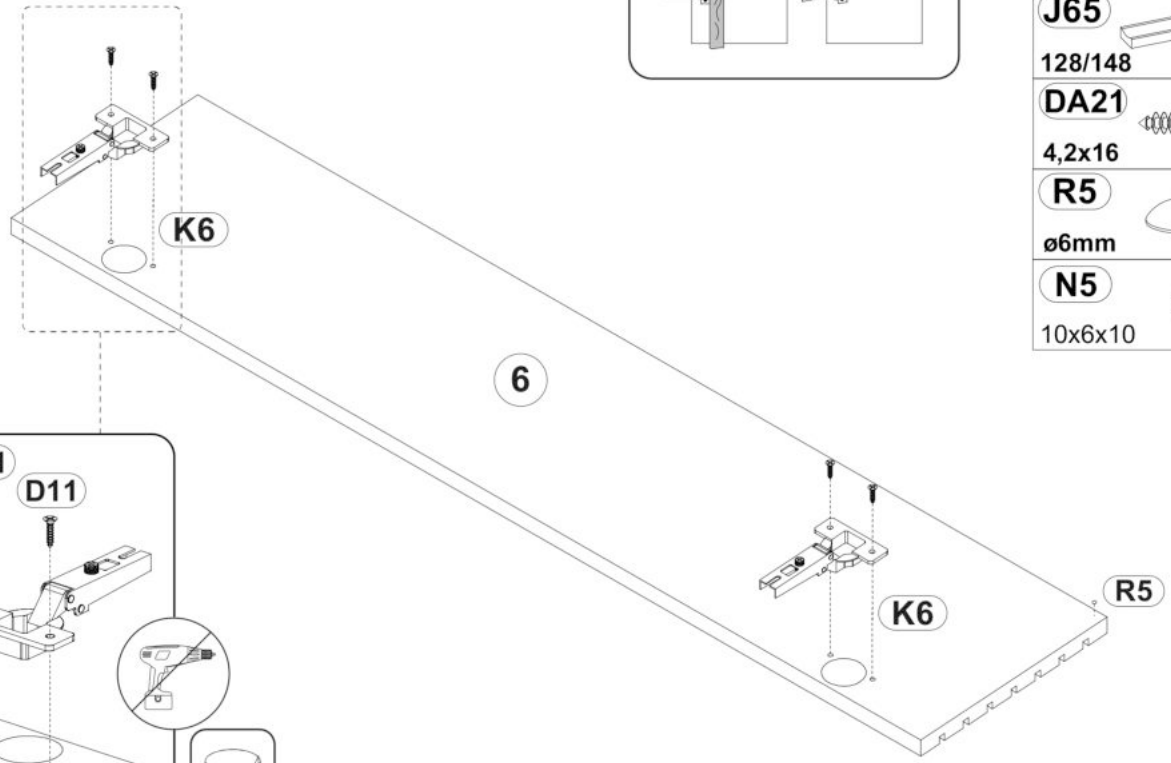

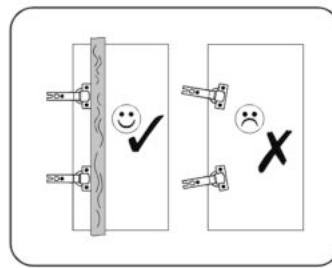
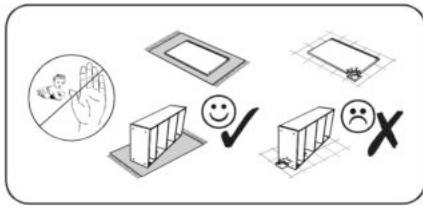

K7		x2
DB2		x2
D11		x4
J65		x1
R5		x1
ø35mm		
4x25		
3,5x16		
128/148		
ø6mm		

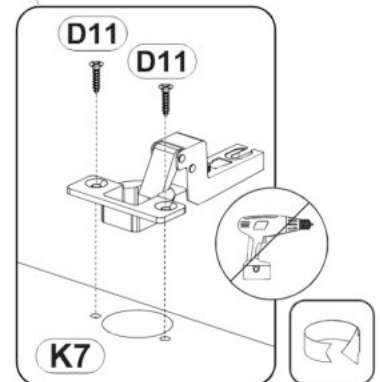
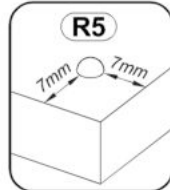
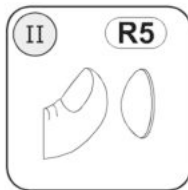
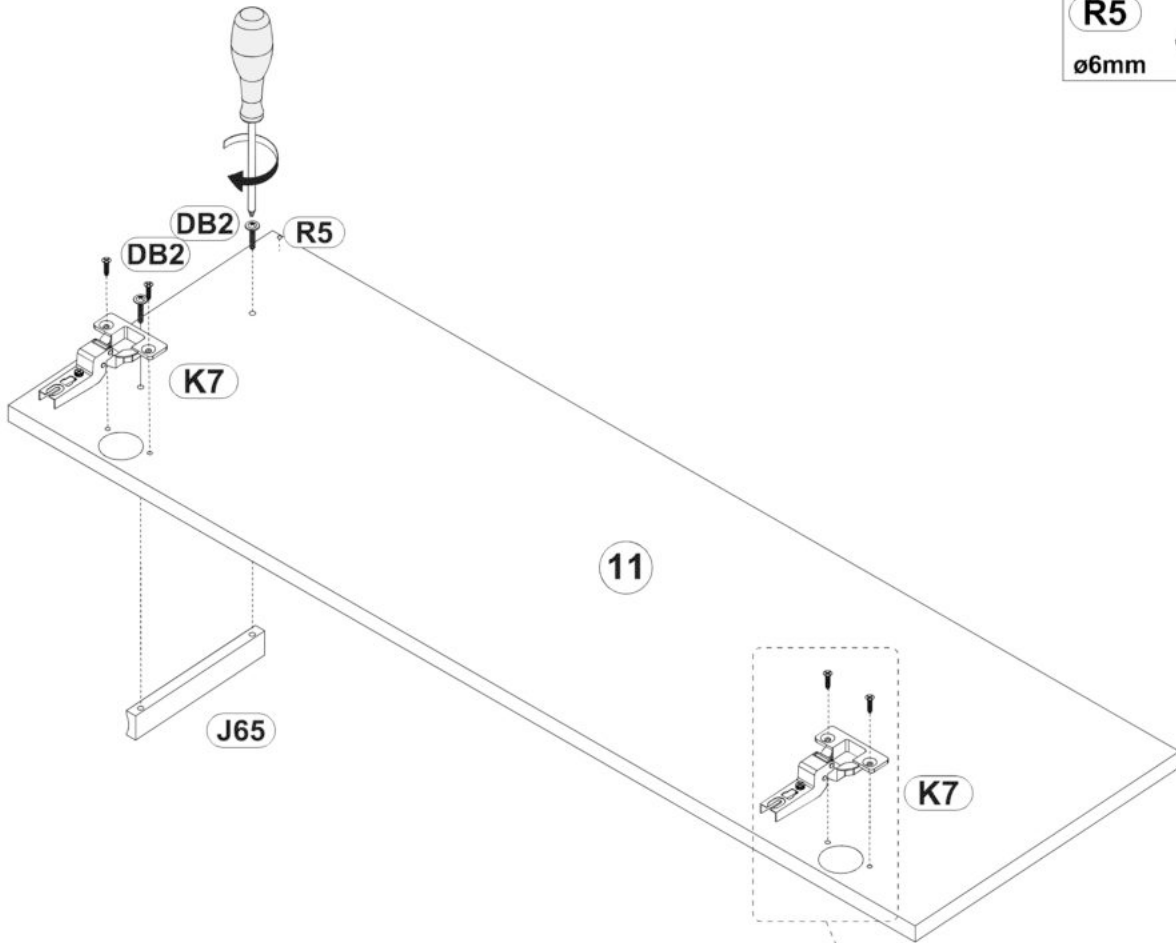

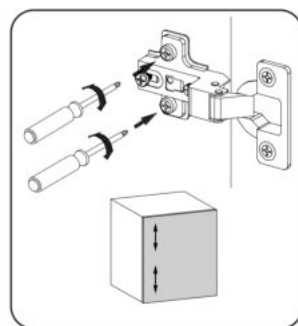
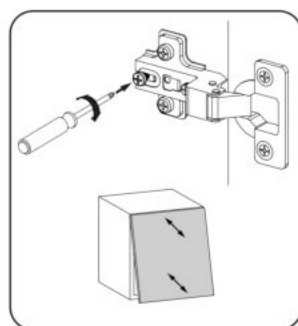
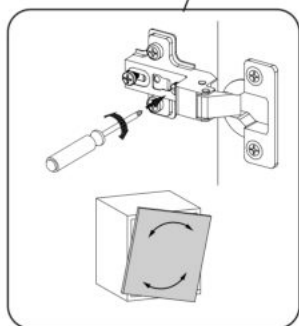
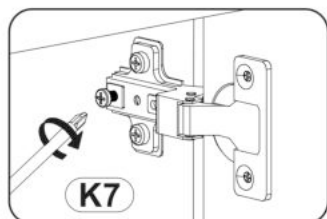
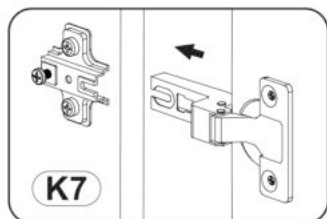
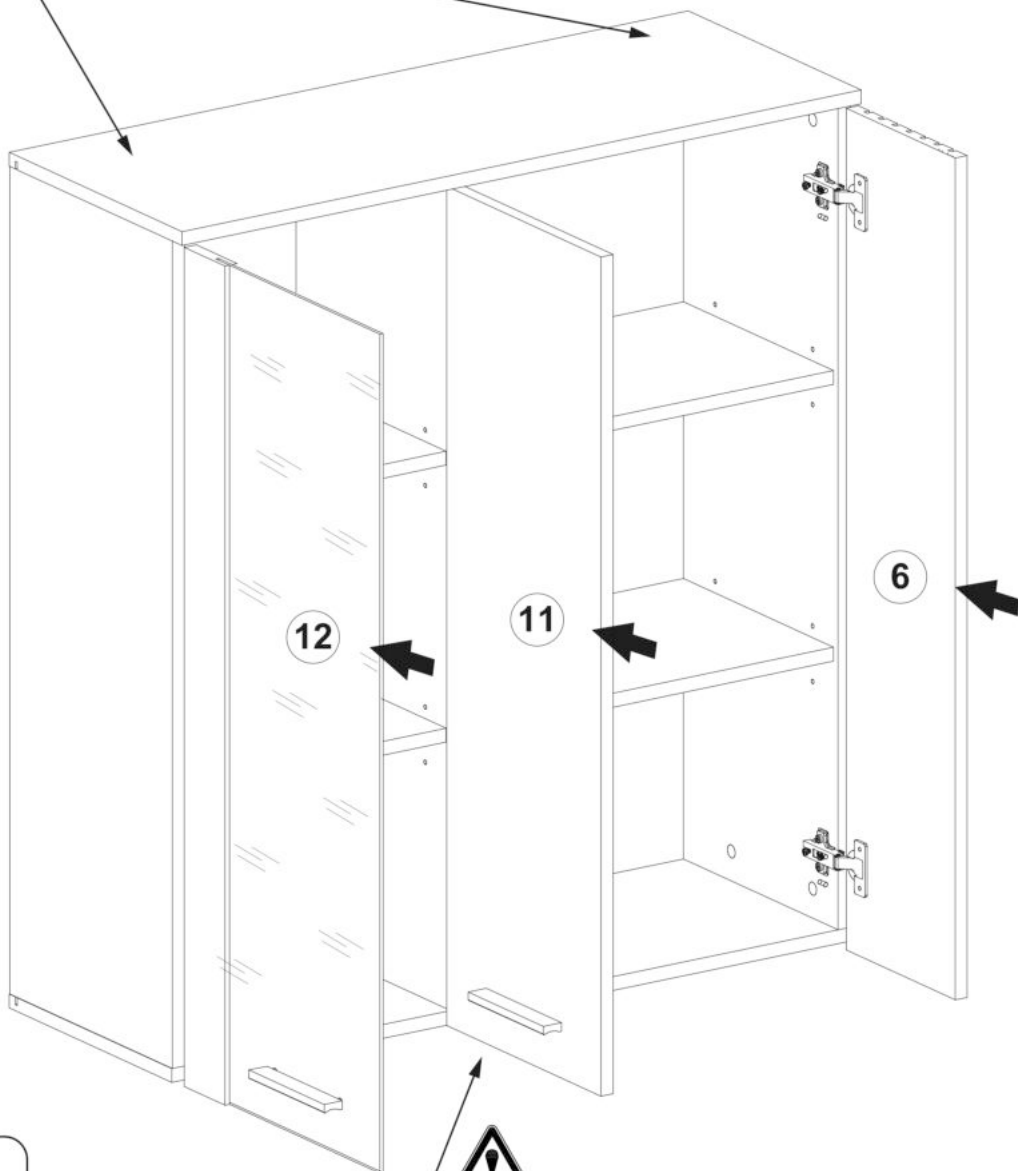
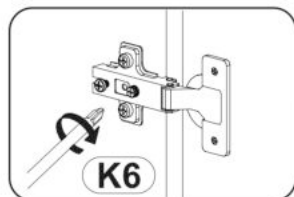
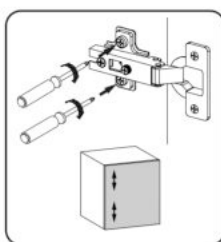
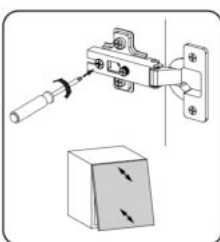
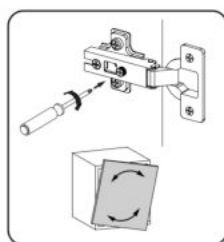
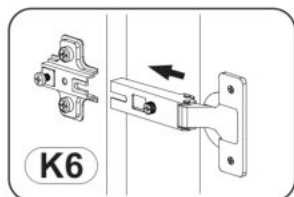

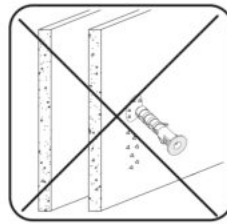
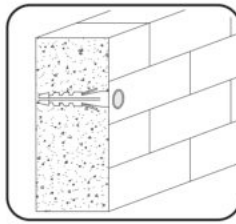

- Y40** 55mm **x2**
- Y39** 10x50 **x2**

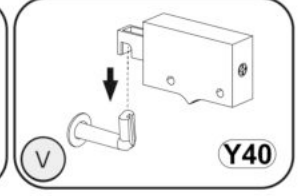
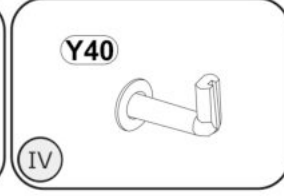
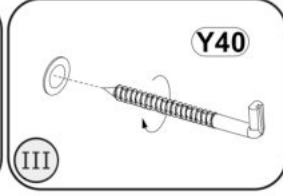
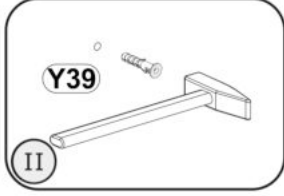
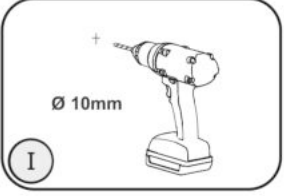

847mm

