

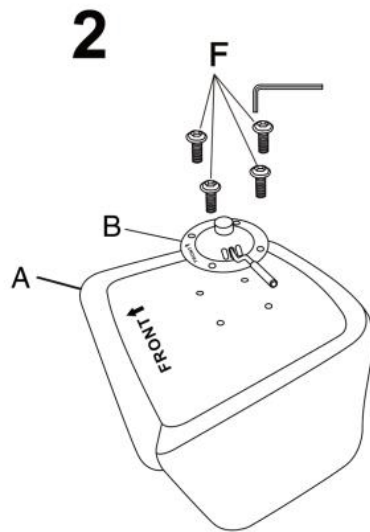

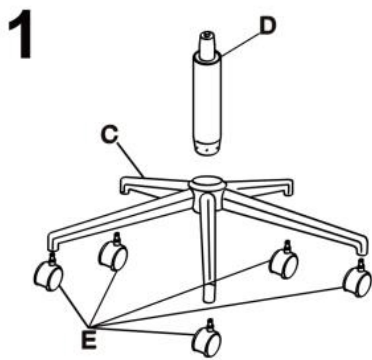



# FRESCO



A		1
B		1
C		1
D		1
E		5
F		4

 max. 100kg

v.1

HALMAR Sp.z o.o.  
 Ul. Centralnego Okregu Przemysłowego 2, 37-450 Stalowa Wola, POLSKA/POLAND  
 tel. +48 15 843 28 10, fax: +48 15 842 19 57, e-mail: office@halmar.com.pl

**NOWOŚĆ**