

# Montáž nábytku

Poznámka: Pred začatím montáže nábytku si prečítajte všetky pokyny na montáž vrátane pravidiel údržby a používania. Postupujte v jednotlivých fázach montáže podľa odsekov uvedených  vo Všeobecných pravidlách pre montáž nábytku.

USCHOVAJTE TENTO NÁVOD POČAS CELEJ DOBY POUŽÍVANIA NÁBYTKU.

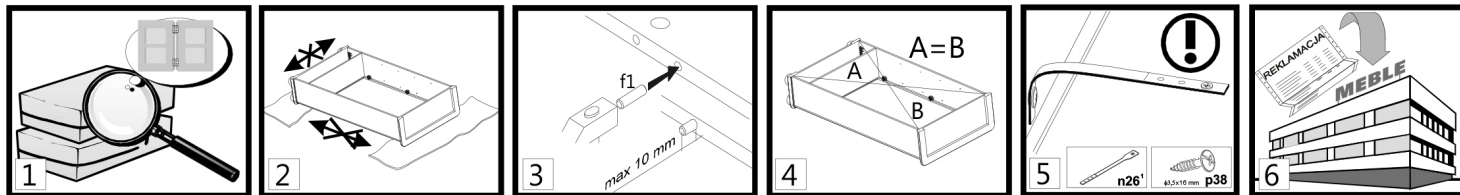



1. POZOR! V montáži nepokračujte, ak sú niektoré komponenty chybné alebo poškodené.
2. Počas montáže položte komponenty na mäkký, čistý povrch, napr. na uterák alebo deku. Nábytok nemontujte na handrách, kobercoch atď.
3. Kolíky f1 zasuňte do otvorov s priemerom 8 mm, ktoré sa nachádzajú na okrajoch komponentov. Otvory pre vačkové skrutky nechajte voľné. Každý kolík, ktorý vyčnieva viac ako 10 mm je potrebné vybrať, vymeniť a skrútiť, pretože môže poškodiť bočnú stenu počas montáže.
4. Pred pripnutím zadnej steny sa uistite, že sú uhlopriečky rovnako dlhé.
5. POZOR! Bezpečnostný popruh. Inštalujte podľa pokynov. Nesprávne upevnený nábytok sa môže počas používania uvoľniť a spadnúť.
6. Vážení zákazníci, v prípade reklamácie uveďte kódové číslo uvedené na prvej strane návodu na montáž. Nahlásiť všetky komentáre a reklamácie tam, kde ste nábytok zakúpili. Ak je to možné, poskytnite štítok chybného výrobku s uvedením dátumu balenia a baliarie.



Vysvetlenia/prípadné poznámky použité v návode na montáž:

Symbol komponentu	Kód	Rozmery [mm]	Množstvo [ks]	Balenie
 A	B	C	D	E

Prvá fáza montáže zahŕňa montáž komponentov so správnym príslušenstvom, ako je špecifikované na nižšie uvedených výkresoch.

-  Symbol  označuje miesta, kde je počas montáže potrebná osobitná opatrnosť.

Nastavovacia skrutka upravuje otváranie dvierok klapky skrinky (utiahnite skrutku, aby dvere klapky skrinky voľnejšie padali). POZNÁMKA!!

-  Nedostatok pre nesprávne nastavenie predstavuje riziko voľného pádu klapky dveri.

**POZNÁMKA!!**

Po kompletnej zostavení pripevnite jednotku na stenu. Nesprávne pripevnený nábytok sa môže počas montáže alebo používania uvoľniť a spadnúť. Jednotku môže na stenu pripevniť len kvalifikovaná osoba.

-  Predtým skontrolujte, či je stena vhodná na to, aby sa na ňu dal pripevniť nábytok. Vyberte vhodnú kotviacu skrutku a skontrolujte pevnosť a kvalitu upevnenia.

**POZNÁMKA!!**

Umiestnite hornú jednotku na základnú jednotku a potom ich spojte pomocou spojovacej dosky n52 a skrutiek p25. Ak sa tento pokyn nedodrží, jednotka sa môže počas používania uvoľniť a spadnúť.

-  Zostavte jednotku podľa nižšie uvedených výkresov s použitím určených konektorov a/alebo spojov.

-  POZOR! Úkon sa musí vykonávať veľmi opatrne, aby nedošlo k poškodeniu časti výrobku.

-  Naneste lepidlo y1 do otvorov znázorneného komponentu, pripevnite ho a počkajte, kým lepidlo zaschne.

-  Lepené miesto dôkladne vyčistite.

-  Úprava

-  POZNÁMKA!! So sklenenými komponentmi zaobchádzajte mimoriadne opatrne, aby ste sa neporezali, nepoškodili alebo nerozbili komponenty.

-  Vyvrtajte otvory podľa výkresov. Pri tejto operácii dávajte pozor, aby ste sa neporezali alebo nepoškodili komponent!

-  Uťahnite skrutky e8 tak, aby nevyčnievali nad ráfik.

-  Možnosť

-  Vložku umiestnite na rám hore nohami na miesto určené pre tento komponent pomocou rozloženej hornej jednotky.

-  Pripojte susedné jednotky pomocou spojovacích skrutiek VHS.

-  POZNÁMKA!! Používajte bezpečnostnú pásku, pretože je nevyhnutná na zaistenie bezpečnosti osôb, ktoré používajú váš nábytok.

-  Dvere môžu byť nainštalované na ľavej alebo pravej strane jednotky.

-  POZNÁMKA!! Lôžková jednotka a klapka majú tendenciu pri zatváraní buchnúť. Existuje riziko zranenia.

-  Na viditeľných miestach použite maskovací pás/jednotku.

-  POZNÁMKA!! Nábytok sa môže uvoľniť a spadnúť, ak sa nepoužijú opatrne.

-  POZNÁMKA!! Vysoko lesklé čelá sú pokryté ochrannou fóliou, ktorá sa po zavesení komponentu odstráni. Povrch týchto predných plôch sa môže čistiť až po 4 týždňoch od odstránenia ochrannej fólie.



Prvky príslušenstva určené na vlastný nákup v špecializovaných predajniach.

## Používanie a údržba nábytku

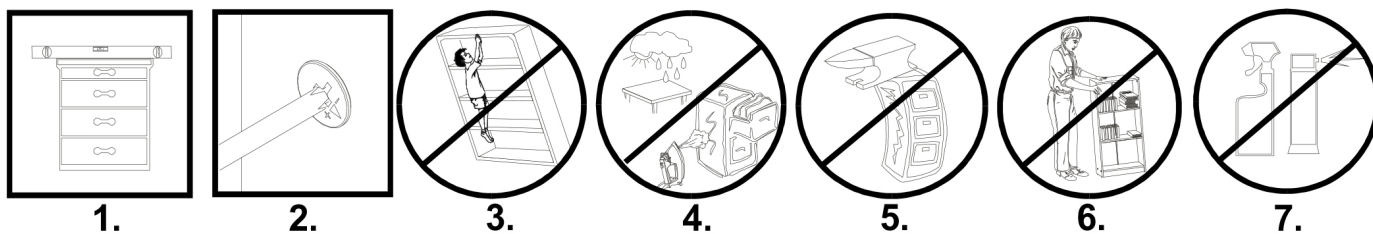

1. Nábytkové jednotky musia byť umiestnené na rovnom povrchu a vyrovnané.
2. Počas používania nábytku skontrolujte stav vačkových čapov. V prípade potreby ich utiahnite.
3. POZNÁMKA!! Nelezte na nábytok
4. Nábytok musí byť umiestnený v suchých miestnostiach s funkčným vetraním a najmenej 1 m od aktívnych zdrojov tepla. Miestnosti musia byť chránené pred nepriaznivými poveternostnými podmienkami (slnčné žiarenie, dážď atď.).
5. POZNÁMKA!! Nadmerné zaťaženie nábytku je pre používateľov nebezpečné a môže spôsobiť trvalé poškodenie.
6. Nábytok sa musí premiestňovať zdvihnutím bez zaťaženia. Poznámka: posunutie alebo ťahanie nábytku môže spôsobiť trvalé poškodenie. Pri premiestňovaní držte vertikálne prvky jednotky, t. j. bočné strany a nohy. Nezachytávajúce vodorovné prvky, napr. konštrukčné police alebo zásuvky, pretože sú náchylné na poškodenie.
7. Nábytok čistite vlhkou handričkou alebo papierovou utierkou

A	B	C			D	E
1	B186-210	1438	405	22	1	1/6
2	B186-211	1438	405	22	1	1/6
3	B186-132	735	405	22	1	1/6
4	B186-133	735	379	16	1	2/6
5	B186-138	735	405	22	1	1/6
6	B186-515	919	360	6	1	3/6
8	B186-033	729	460	19	1	2/6
9	B186-034	729	460	19	1	2/6
23	B185-507	440	208	4	1	5/6
11	B185-508	440	395	4	1	4/6
12	B186-909	744	467	2,5	1	2/6
13	B186-501	350	150	16	3	1/6
14	B186-502	350	150	16	3	1/6
15	B186-509	401	136	16	3	1/6
16	B186-510	64	379	16	3	2/6
17	B186-916	355	415	2,5	3	1/6
18	B186-035	460	241	19	1	2/6
19	B186-036	460	241	19	1	2/6
20	B187-037	460	241	19	1	2/6
21	B186-923	744	934	2,5	1	2/6
10	B186-308	918	370	15	1	2/6
24	dodatki				1	6/6

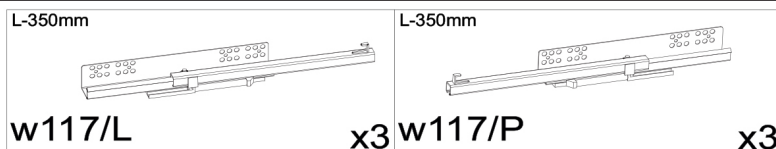
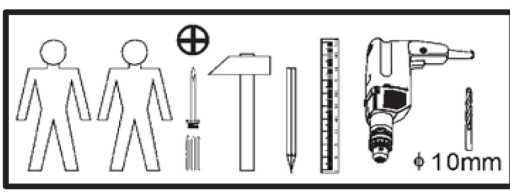
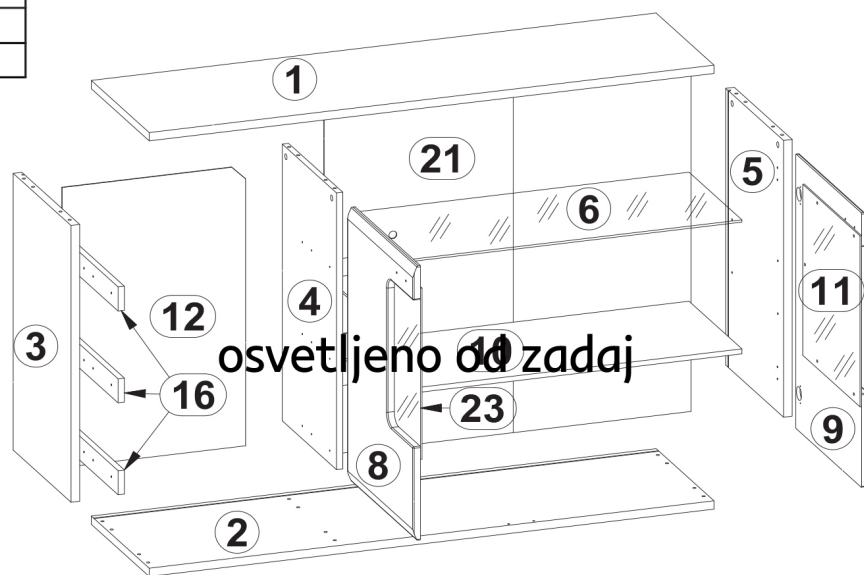
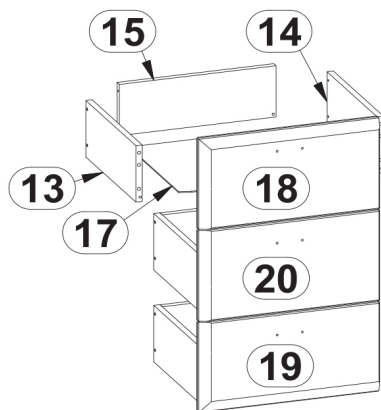
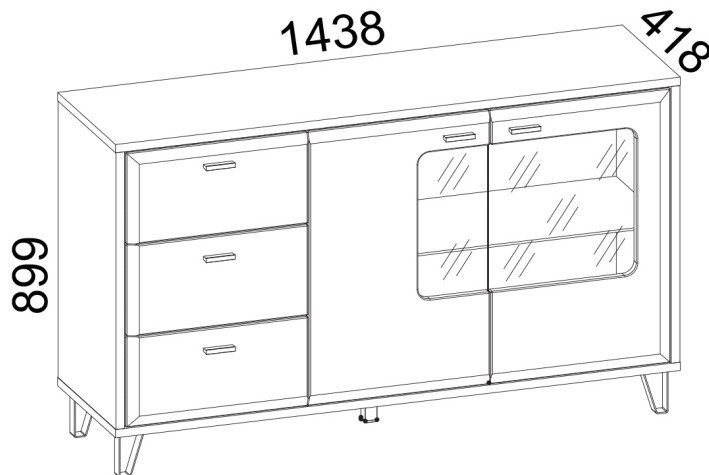

e2 x1	a205 x2	a203 x2	a63 x2	d1 x4	b90 x4	p51 x8	s67 x1
f1 x22	z1 x1	p38 x47	e3 x9	e25 x9	o1 x8	n108 x4	n14/2 x1
f35 x1	p17 x1	i2 x18	cb6 x5	j8 x10	nb1 x4	e27 x6	r42 x18
r1 x14	r3 x4	s2 x18	p64 x12	d4 x4	d3 x4	k38/3 x1	k38/7 x1

# 1

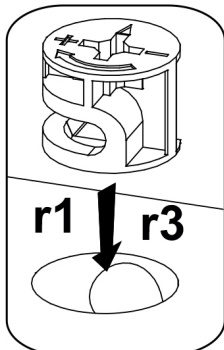
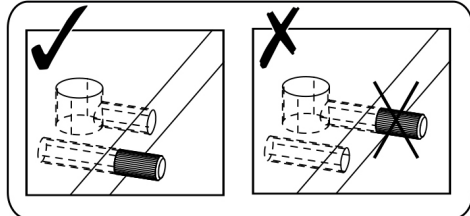
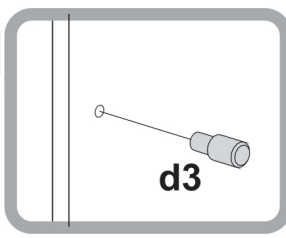
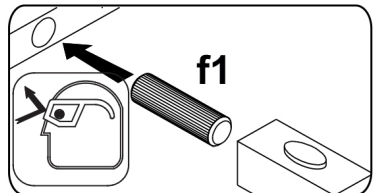
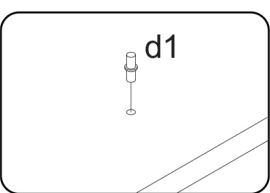

D5mm d3	Ø8x30 mm f1	x12 b90	Ø15x12 mm #16 r1	x4 r1	x2
Ø15x15 mm #22 r3	6x28mm e25	x9 w117/P	x3		
D5mm d1	6x13mm e3	x9 w117/L	x3		

5

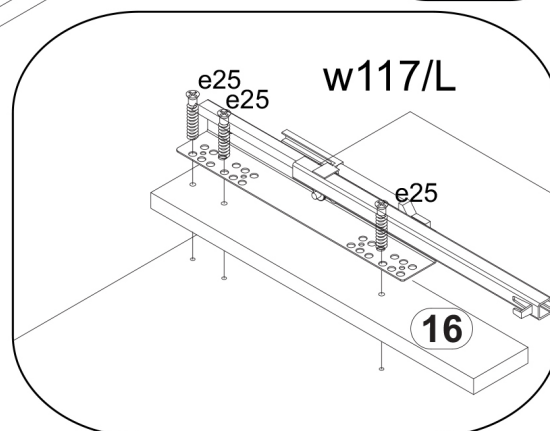
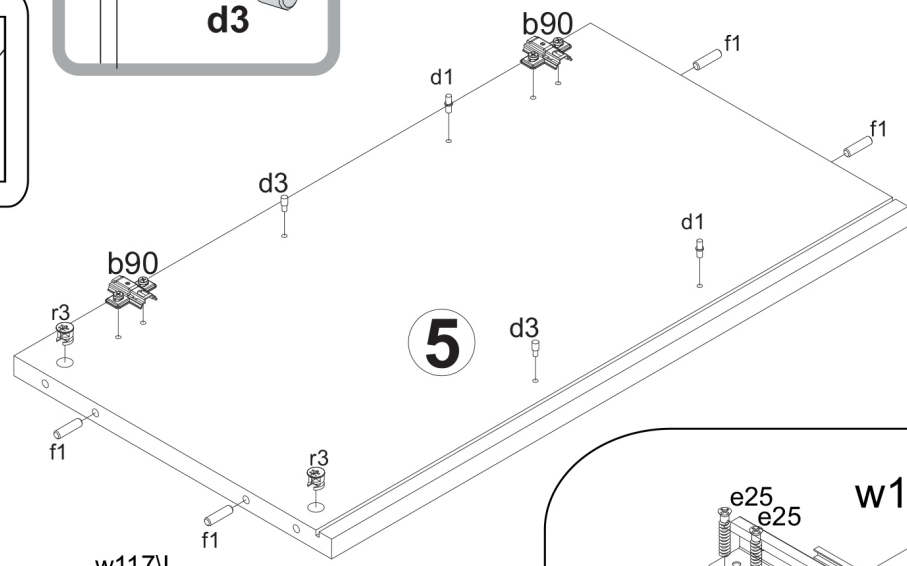
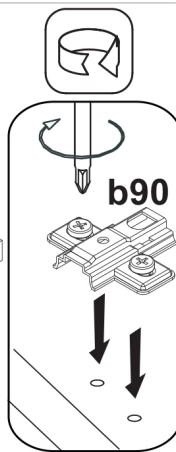

16

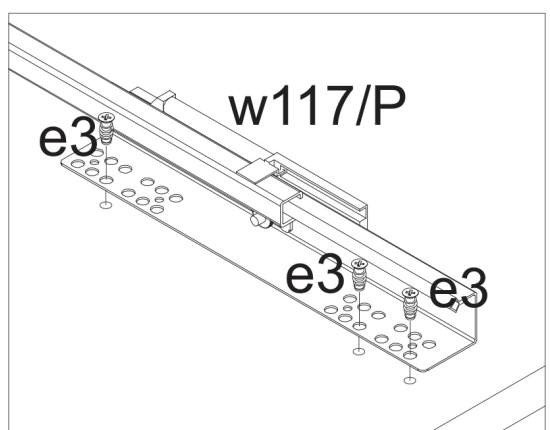

180°



16

3

4

4

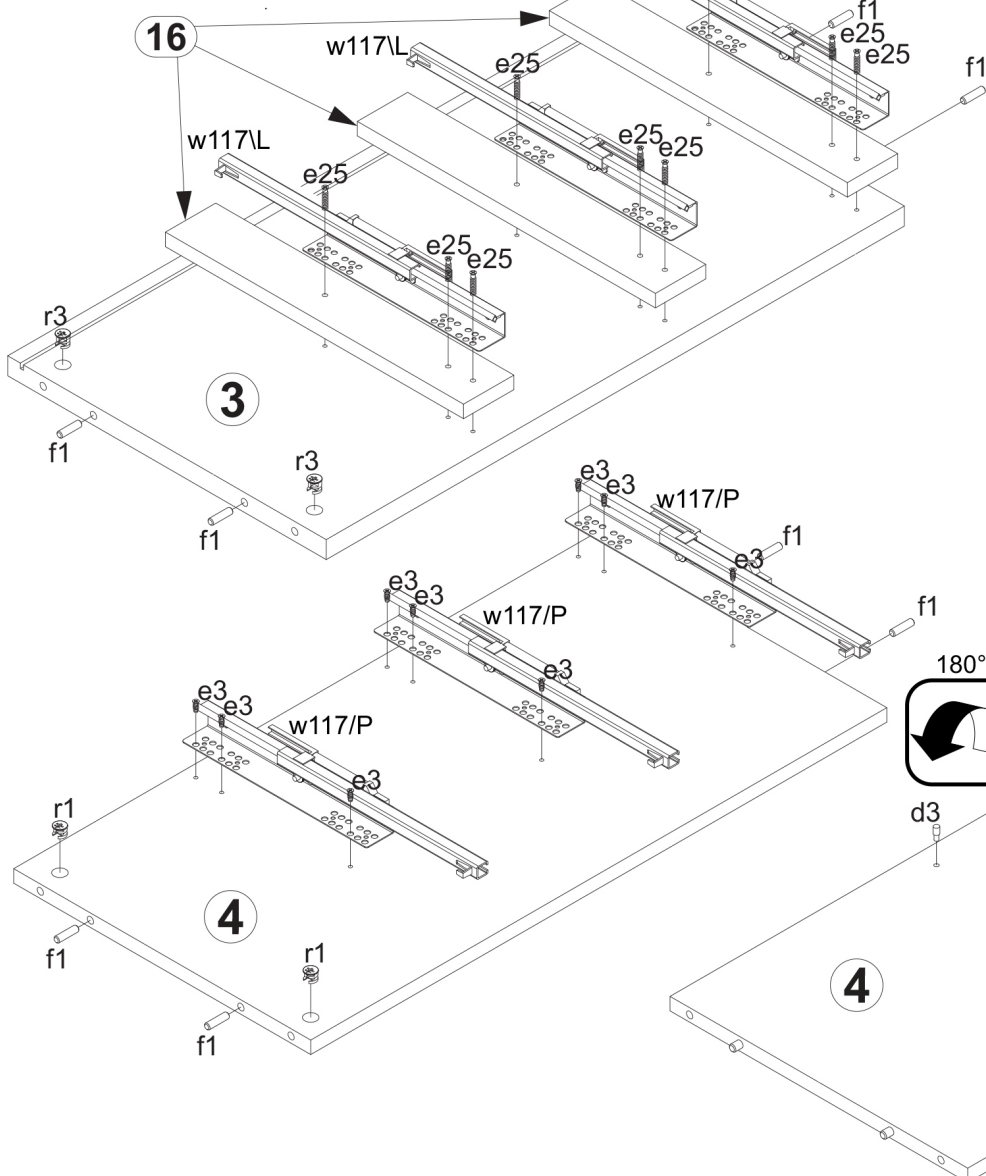



# 2

Ø6,3x15mm 20/11  
d4 x4 r42 x6

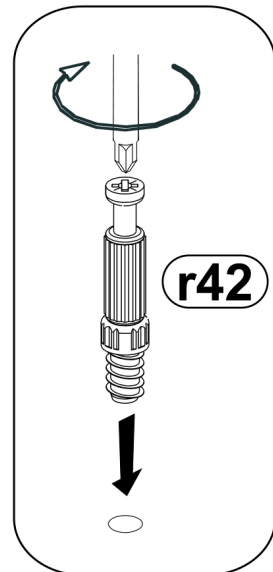
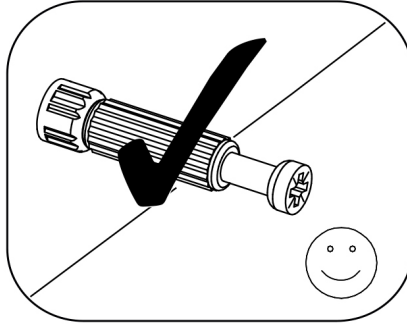
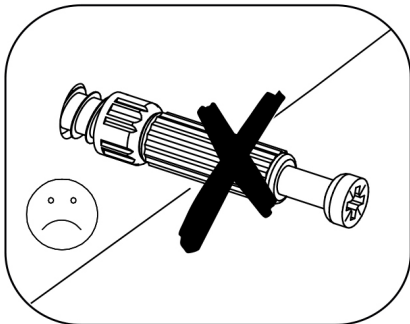
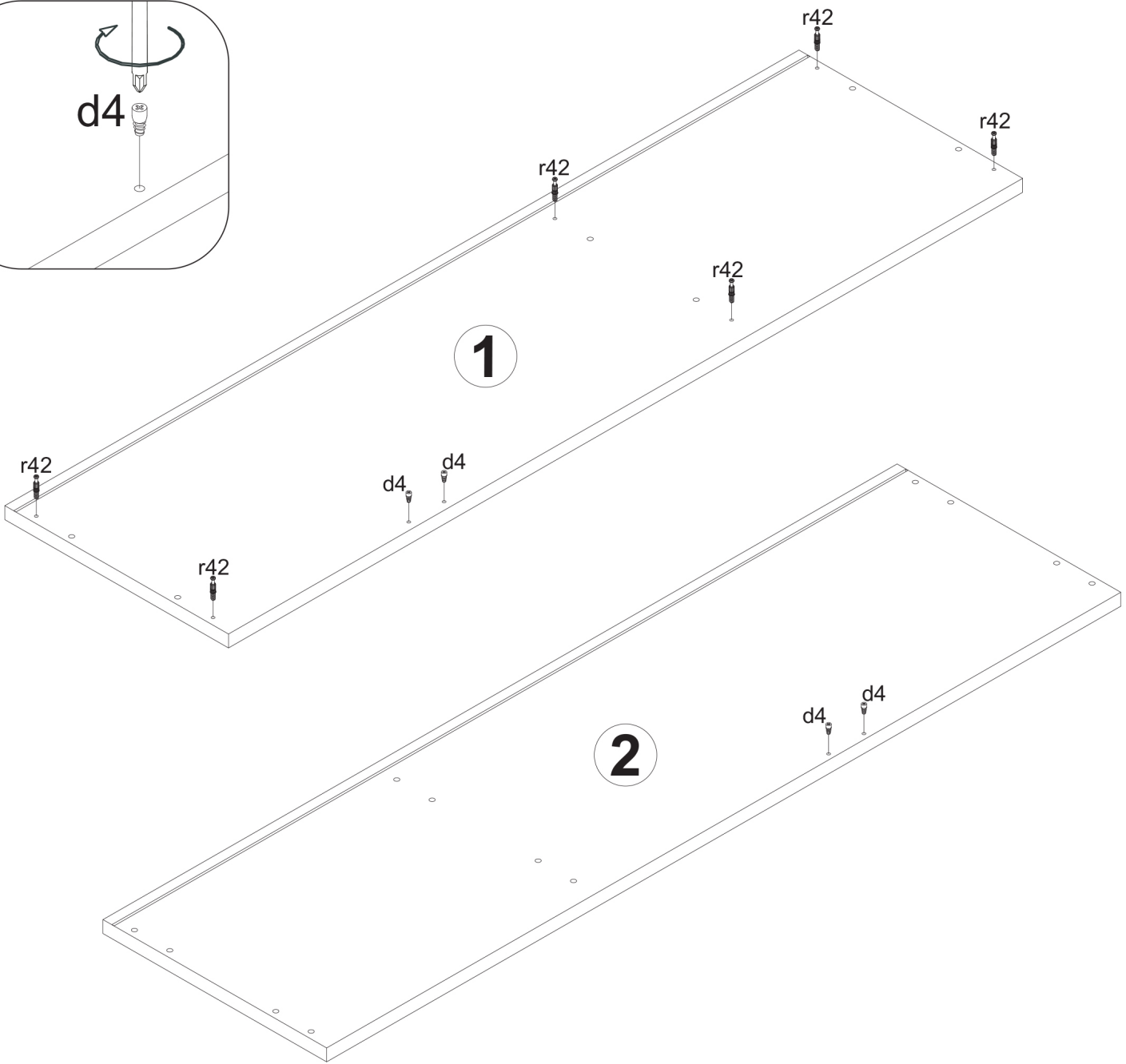
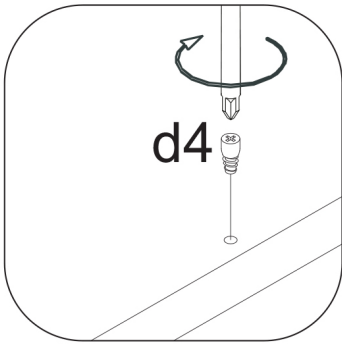



# 3

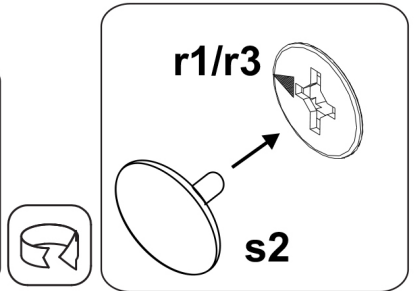
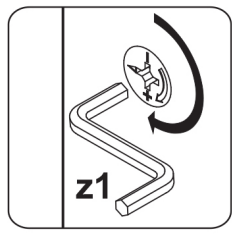
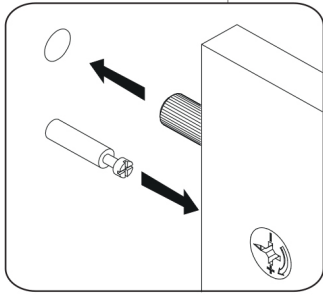
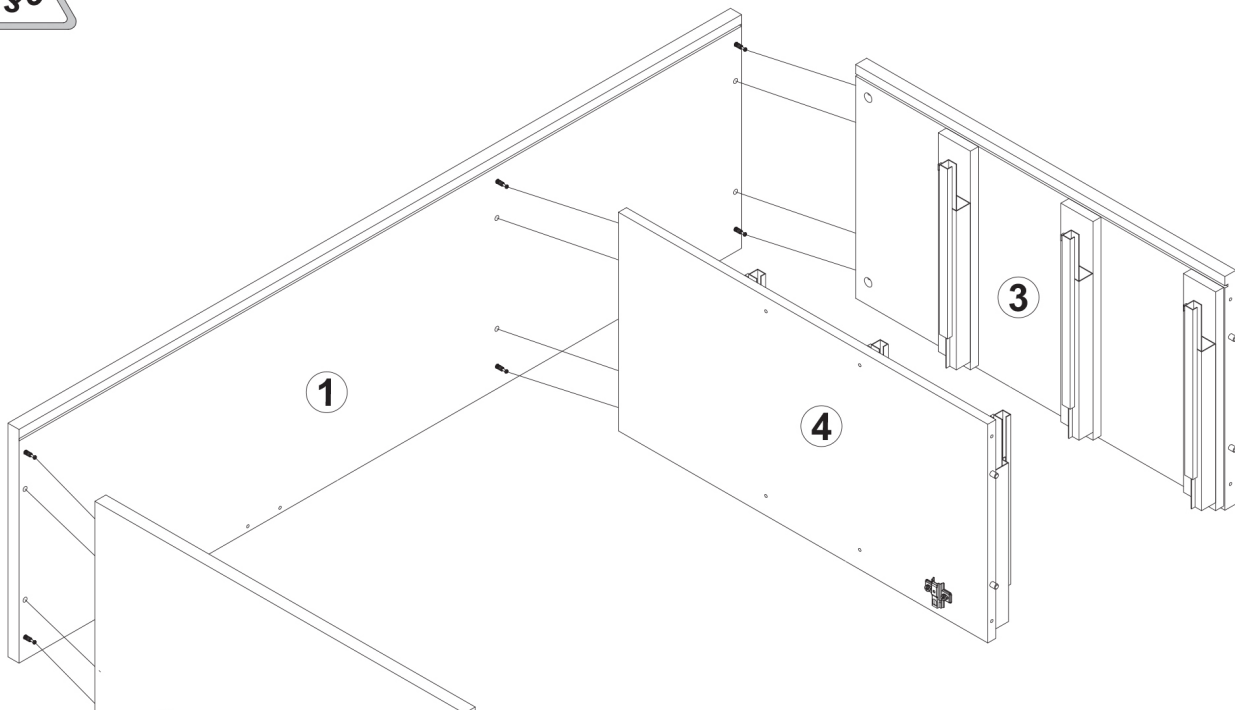
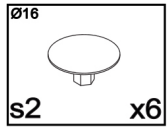

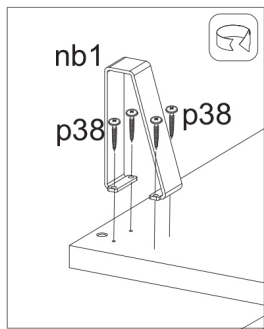

# 4

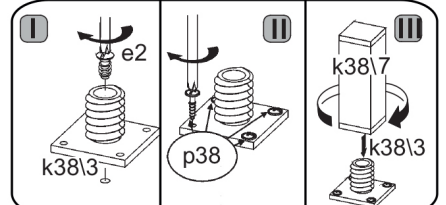
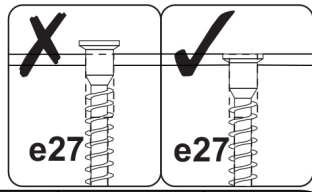
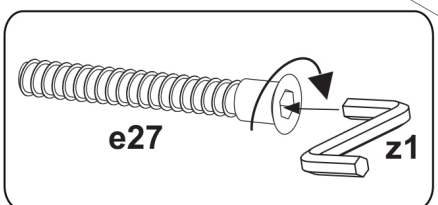
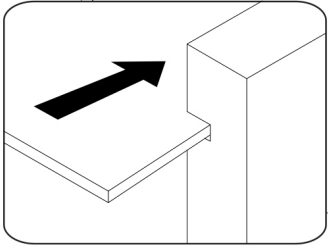
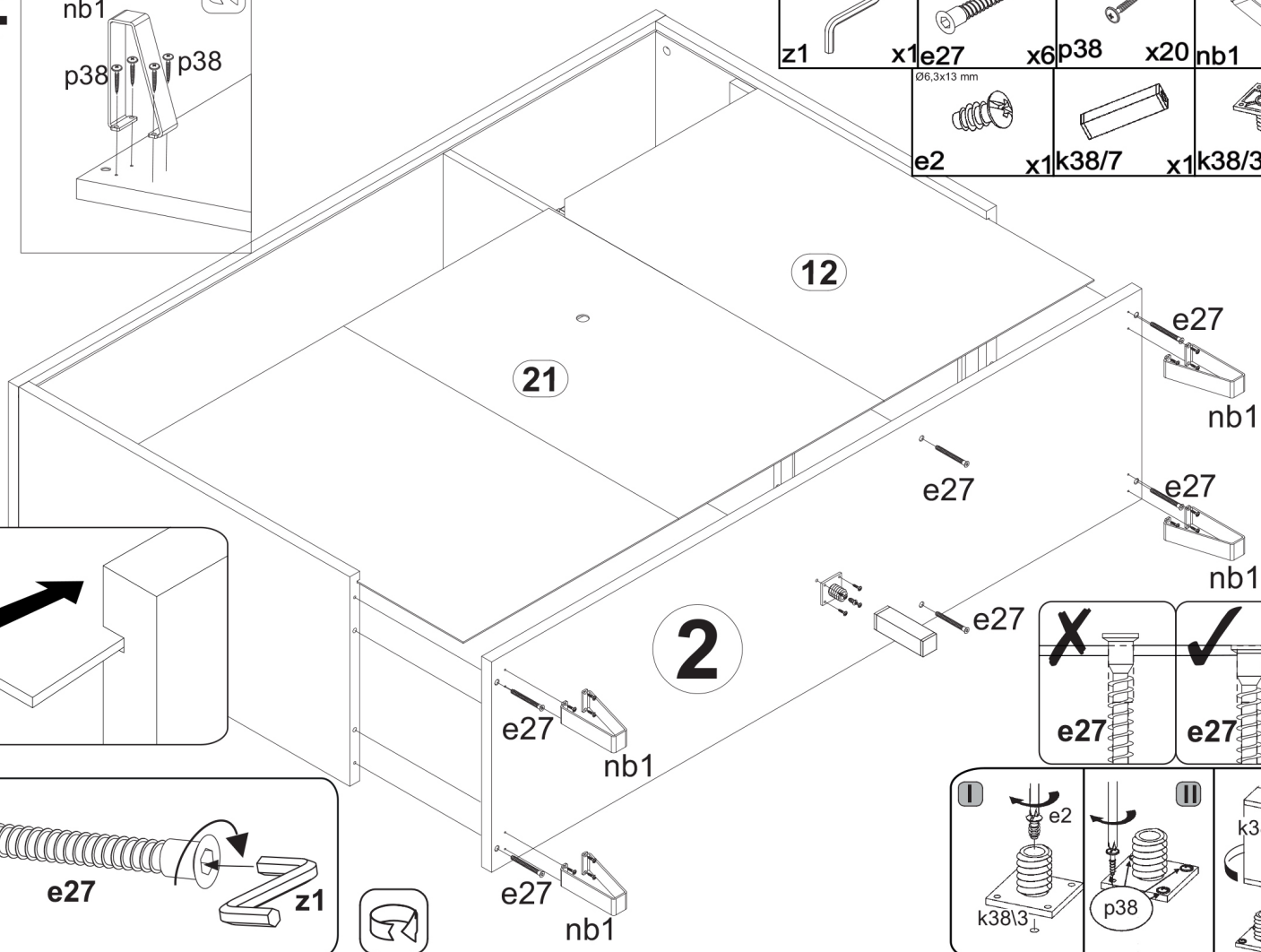

<b>z1</b>	<b>x1 e27</b>	<b>x6 p38</b>	<b>x20 nb1</b>
<b>e2</b>	<b>x1 k38/7</b>	<b>x1 k38/3</b>	<b>x1</b>



# 5



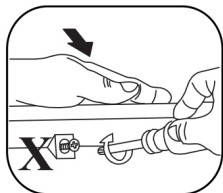
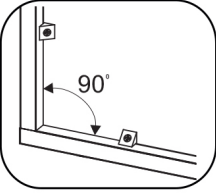

 p38	x3	 n108	x3
		 l2	x18

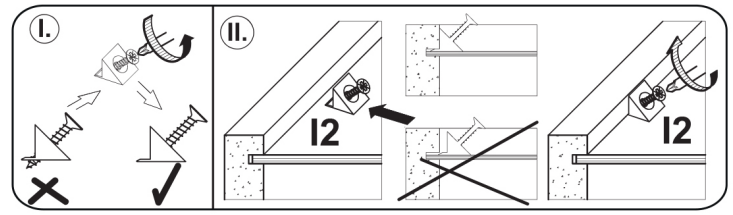
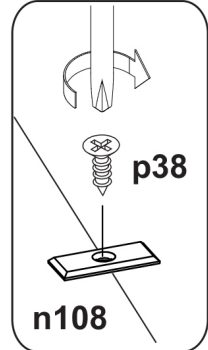
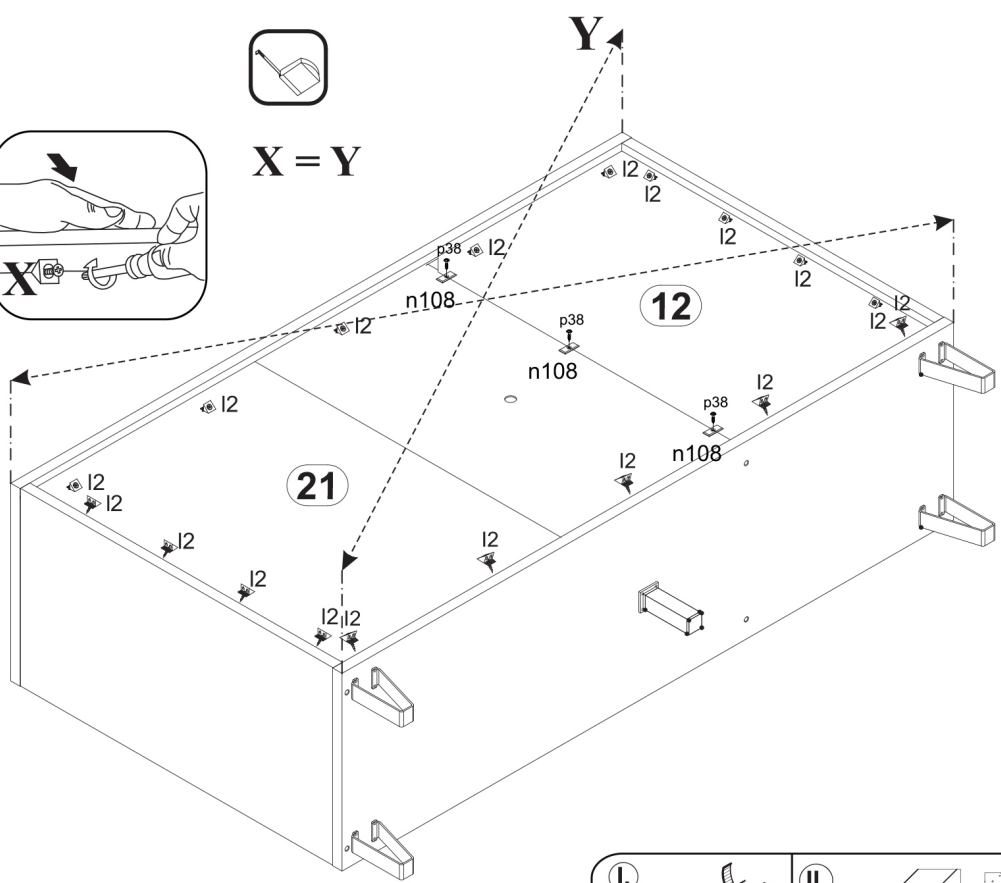

X = Y



# 6

 p17	x1	 f35	x1	 n14/2	x1	 p38	x1	
							 s67	x1

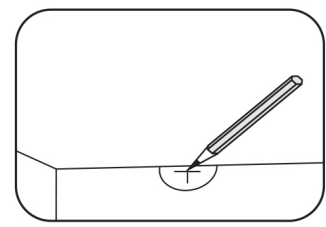
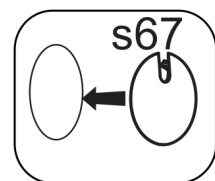
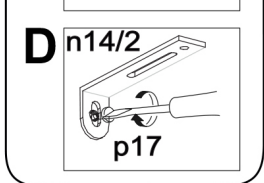
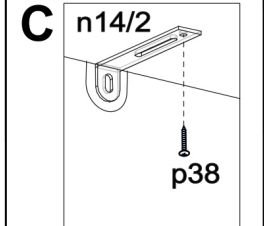
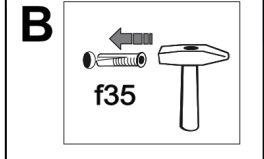
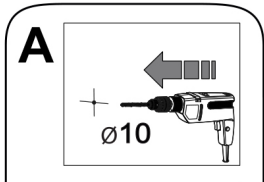
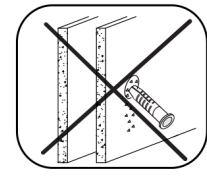
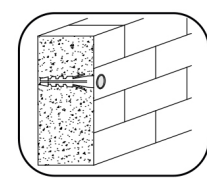
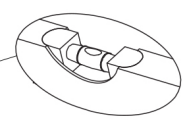
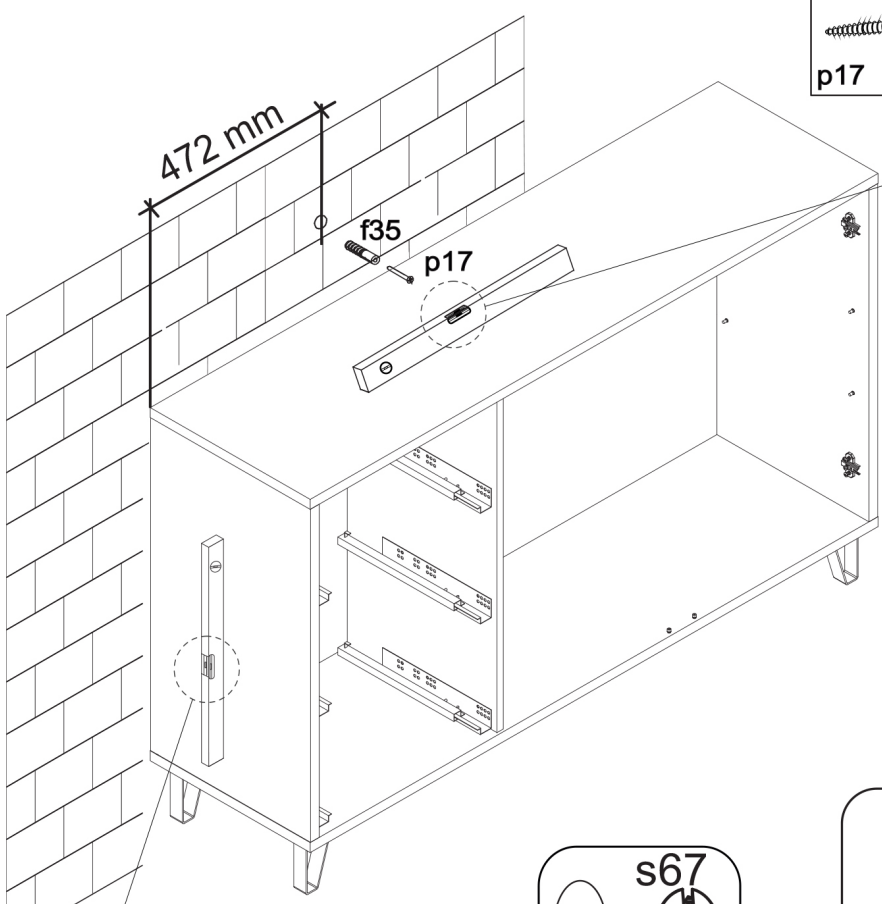

64mm cb6 x3	M4x25mm j8 x6	20/11 r42 x12	Ø15x12 mm #16 r1 x12	Ø8x30 mm f1 x6	Ø4x40mm p64 x12	Ø16 s2 x12	Ø3,5x16mm p38 x9	z1 x1
-------------------	---------------------	---------------------	----------------------------	----------------------	-----------------------	------------------	------------------------	----------

## x3

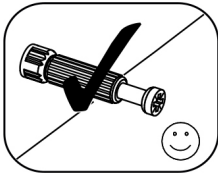
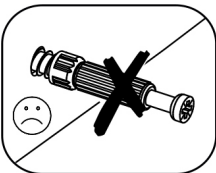
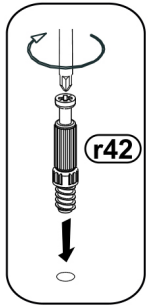
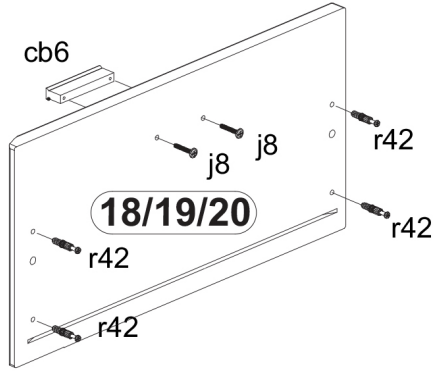

## x3

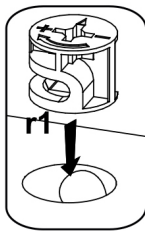
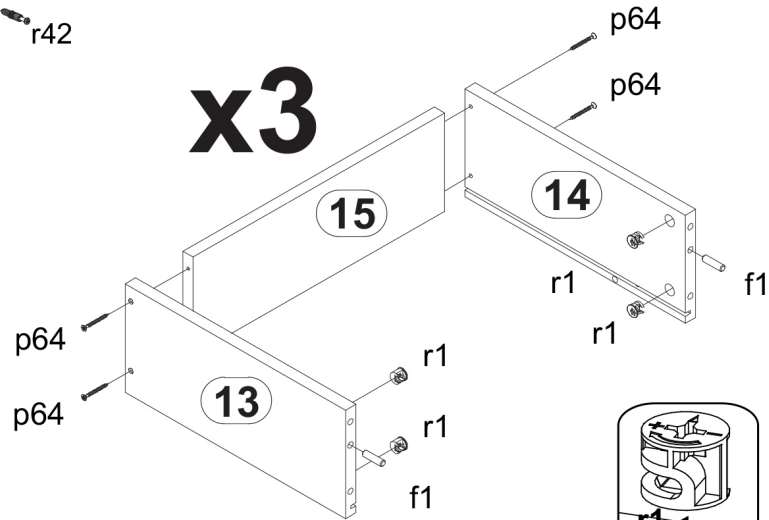

## x3

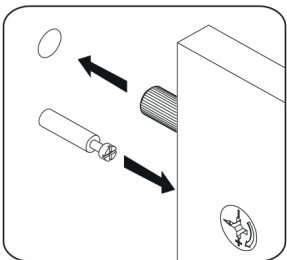
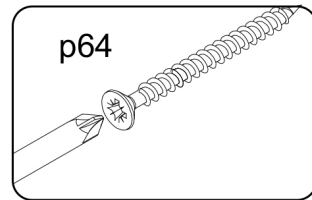
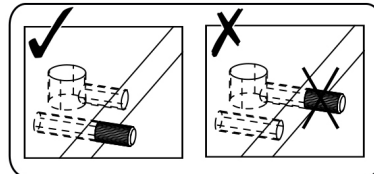
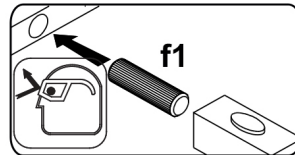
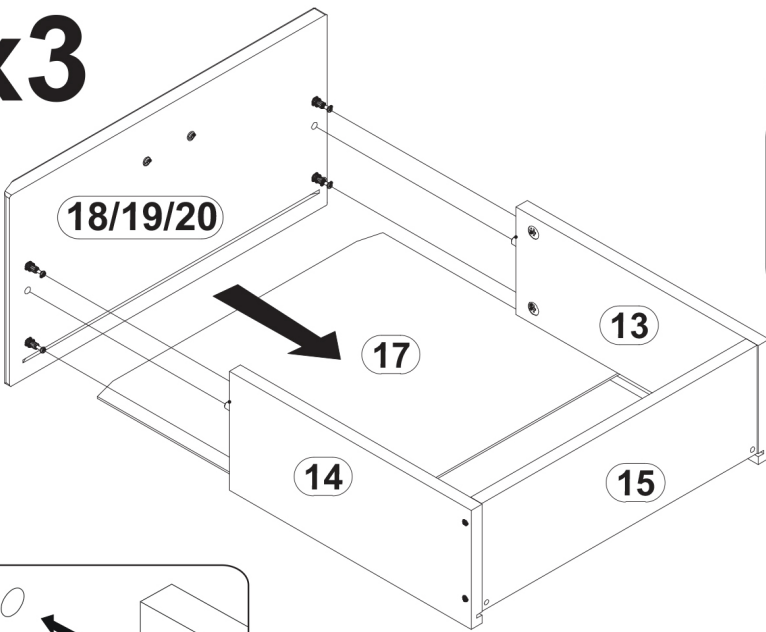

## x3

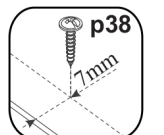
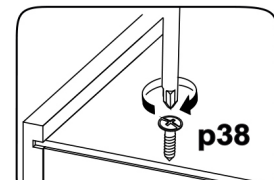
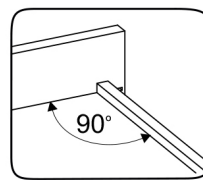
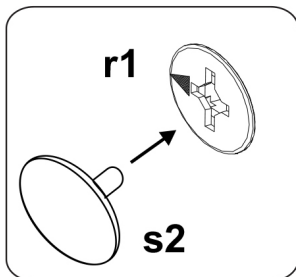
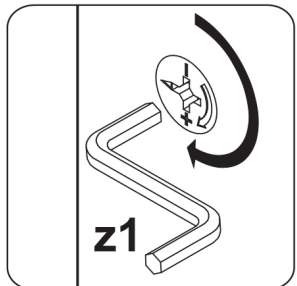
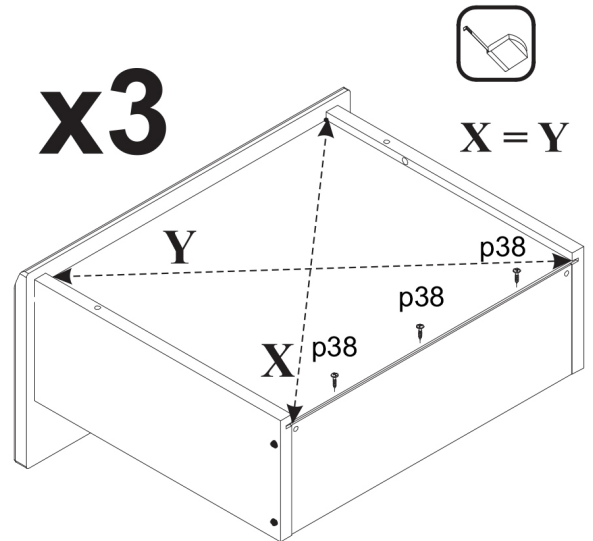



# 8

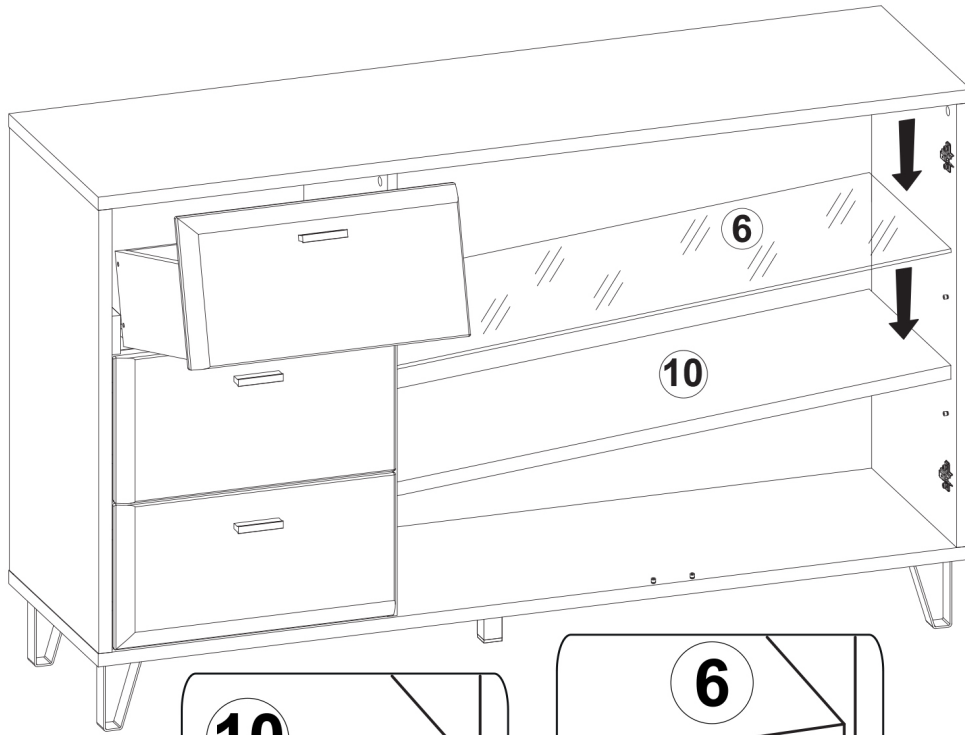

Ø3,5x16mm  
p38 x6

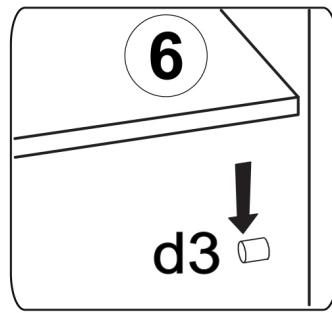
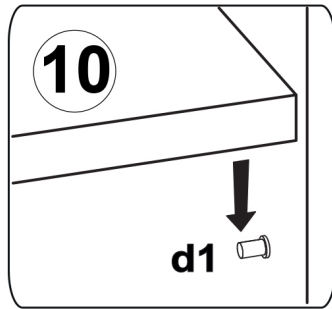
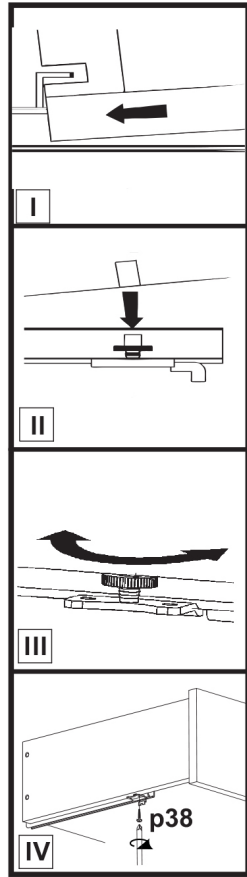

# 9

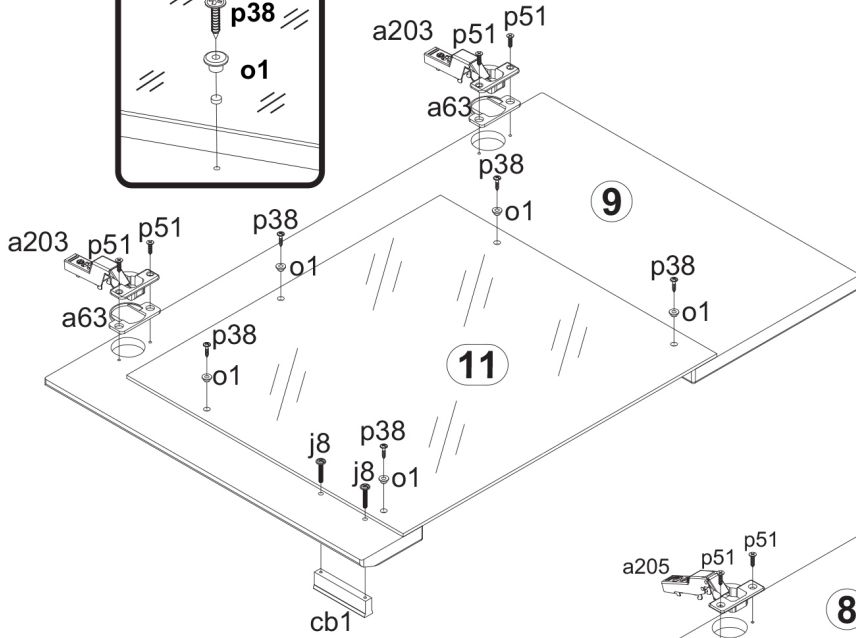
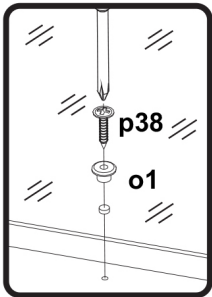

<p>o1 x8</p>	<p>p51 x8</p>	<p>a63 x2</p>	<p>a203 x1</p>
<p>p38 x8</p>	<p>j8 x4</p>	<p>cb6 x2</p>	<p>a205 x1</p>

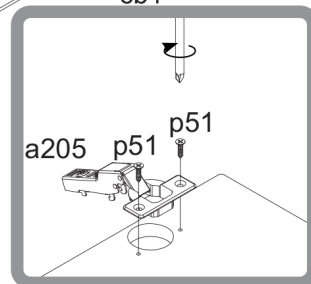
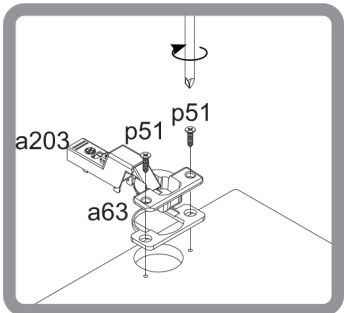
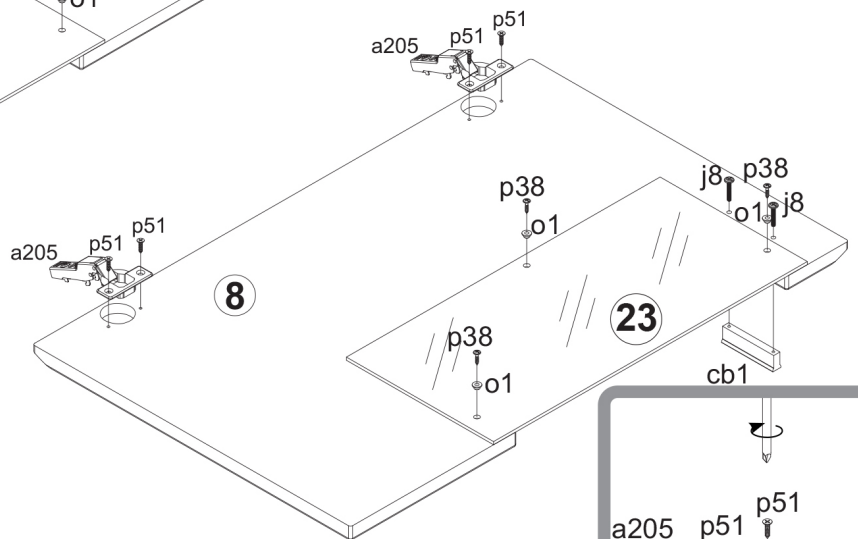

# 10

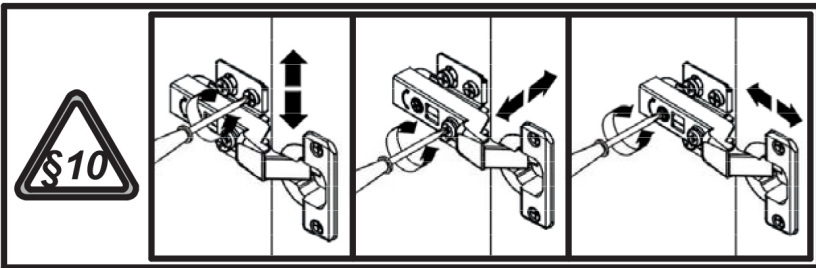
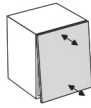
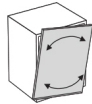
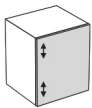
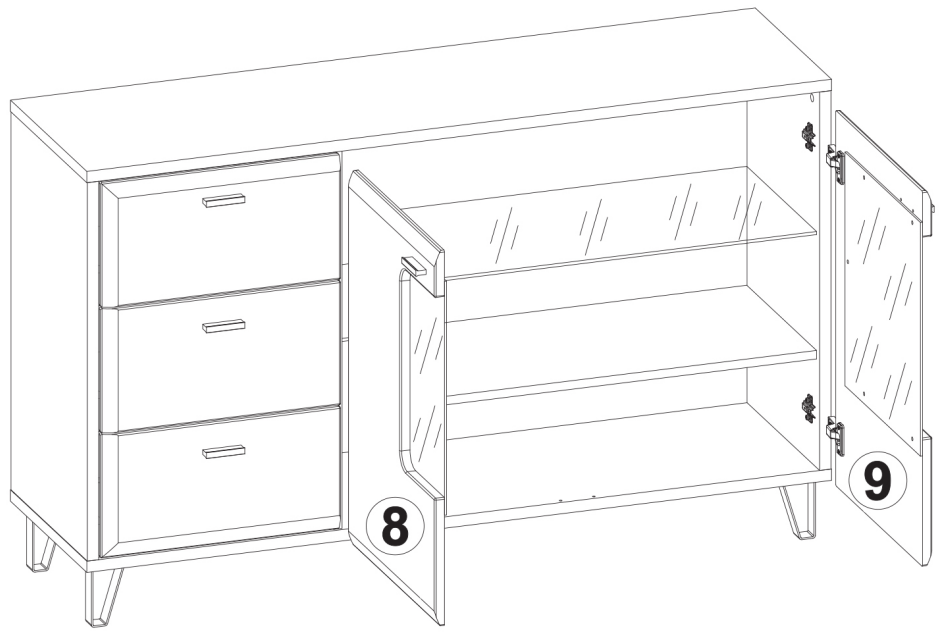
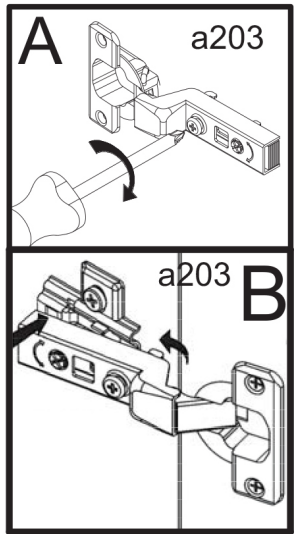

# 11 **§14**

**B186-KOM2W3S** osvetljeno od zadaj

