

GREEN

Art.-Nr.

305 838
305 839
305 840

↔	1430
↕	1750
↗	520
	mm

1/8
VO

	120min			PZ1, PZ2	0,5 kg	3m	600 mm	Ø8	4
--	--------	--	--	----------	--------	----	--------	----	---

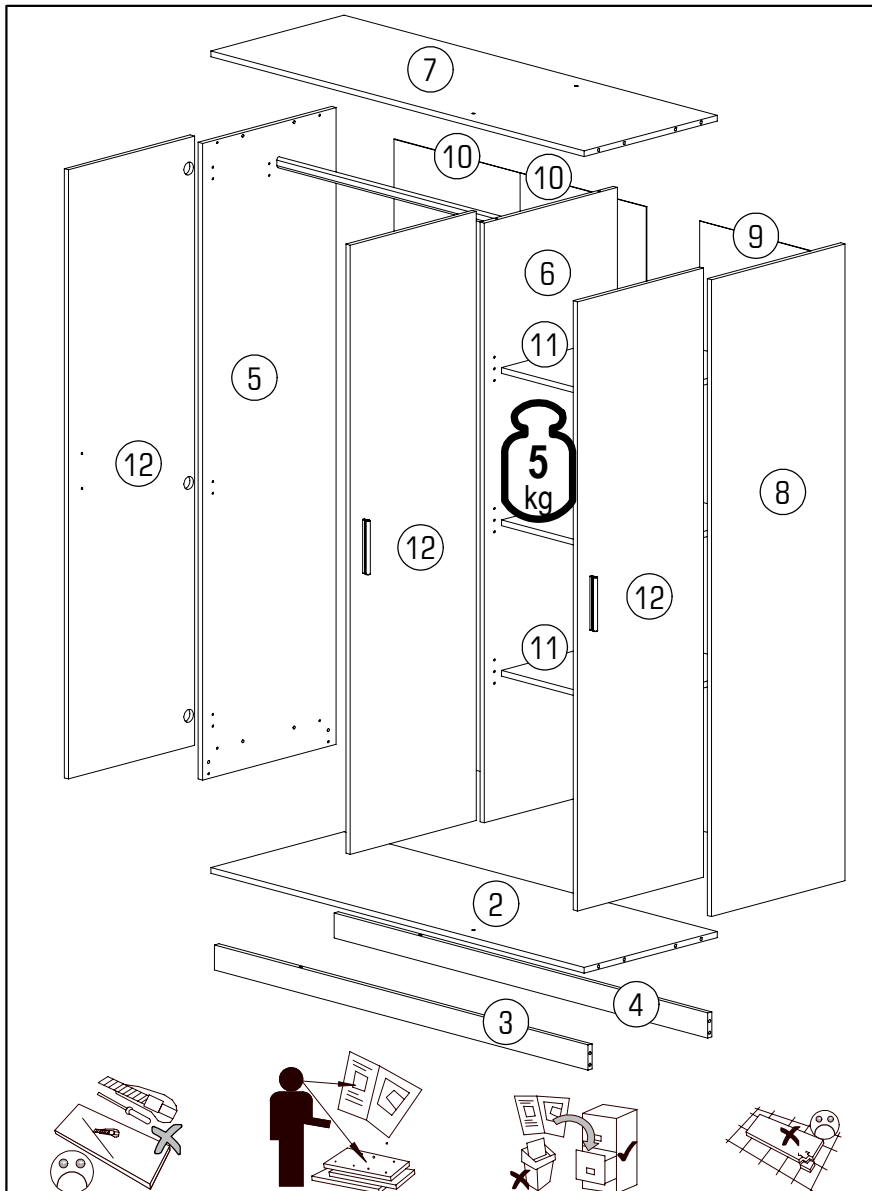



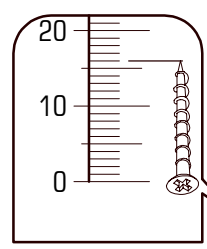
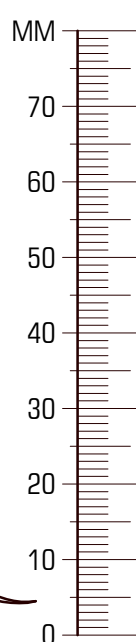
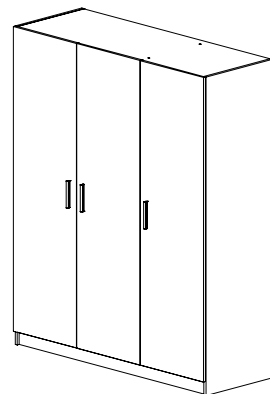



ID	ID	Icon	Dimensions	Quantity	Order
18478	②		499*1398*16	1x	1/3
18479	③		1398*69*16	1x	1/3
18512	④		69*1398*16	1x	1/3
18480	⑤		1750*500*16	1x	2/3
18481	⑥		499*1648*16	1x	2/3
18482	⑦		499*1398*16	1x	1/3
18483	⑧		1750*500*16	1x	2/3
18484	⑨		1674*480*3	1x	2/3
18485	⑩		1674*472*3	2x	3/3
18486	⑪		460*498*16	3x	1/3
18487	⑫		1674*472*16	3x	3/3



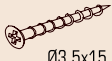



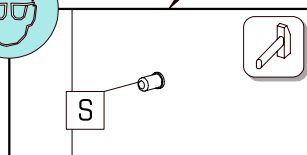
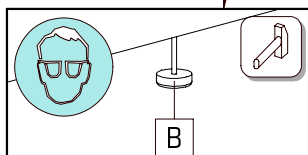
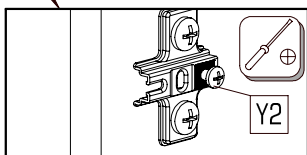
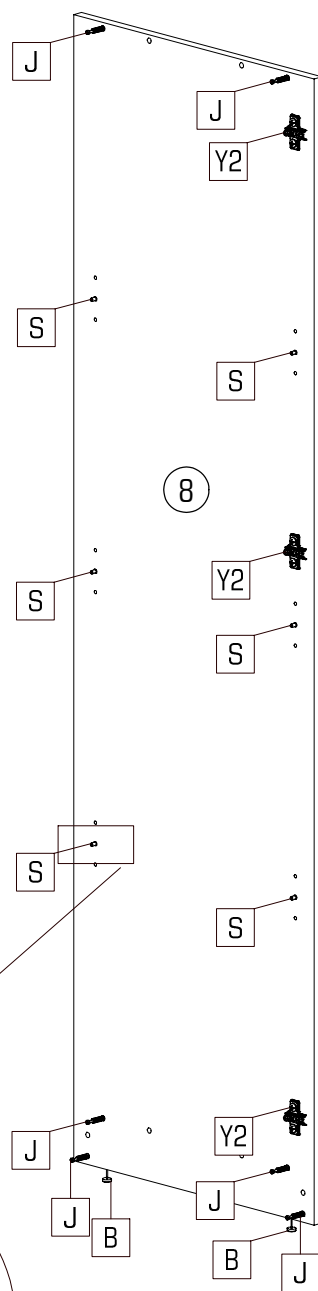
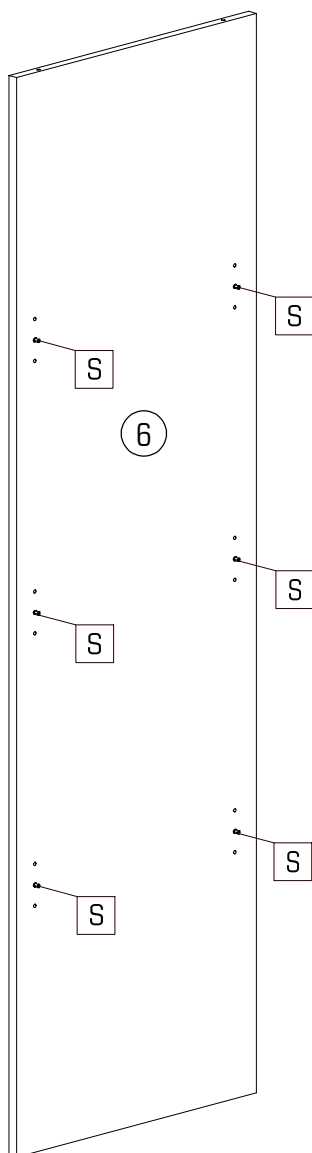
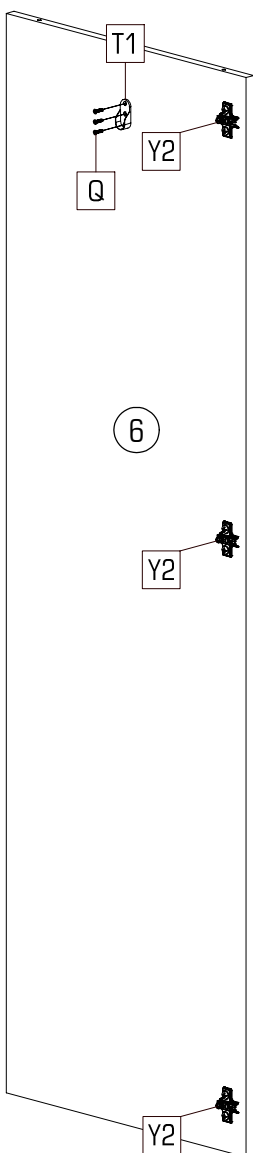
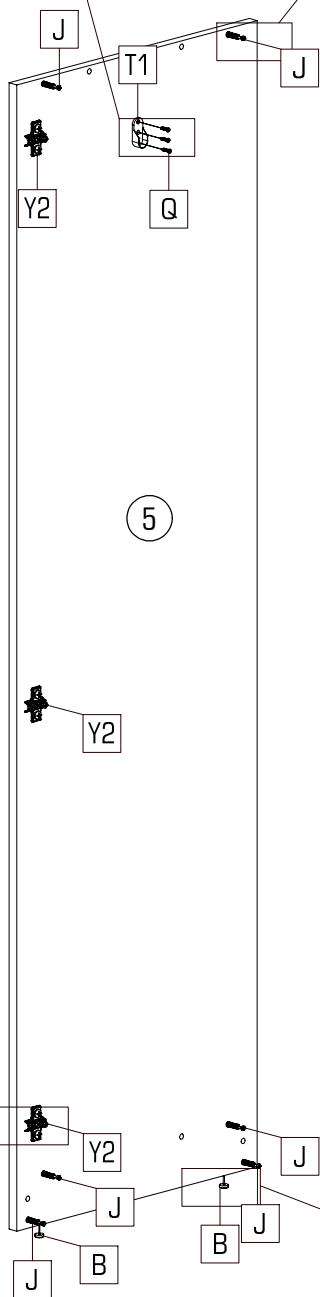
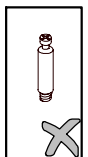
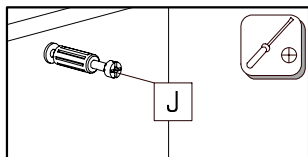
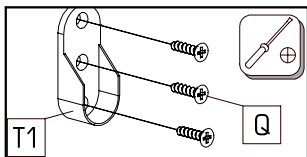

22244.01 Ø3,5x16	30091.00	22300.00 Ø7x50	27000.00 Ø8x30	21102.00 Ø1,6x20	70013.01 Ø15x13	70021.01	22430.00 Ø4x25
A 2x	B 8x	D 4x	F 16x	G 50x	H 12x	J 12x	K 6x
82030.00 L=148	24103.00 Ø8	22243.00 Ø3,5x15	24008.00 3,0	85101.01	70018.01	70017.59 L=914	
M 3x	N 4x	P 1x	Q 24x	R 16x	S 12x	T1 2x	T2 1x
22213.00 Ø4x70	31103.00	22236.00 Ø2,5x16	36002.07	36002.07	36002.07		
U 1x	V 1x	W 16x	Y1 9x	Y2 9x			

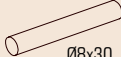
--	--	--	--	--	--	--	--	--	--

					
B	4x	J	12x	Q	6x
		J	12x	T1	2x
		Y2	9x		

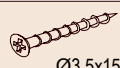

						
B 4x	F 8x	H 4x	K 6x	M 3x	Q 18x	Y1 9x

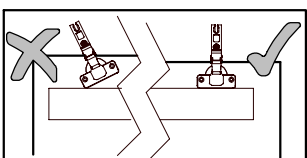
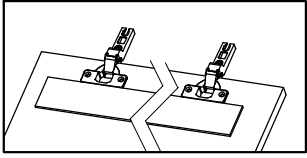
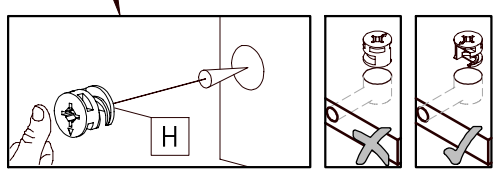
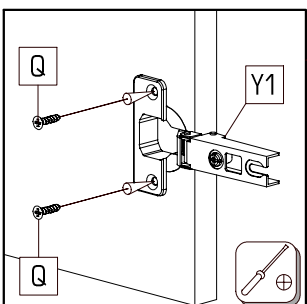
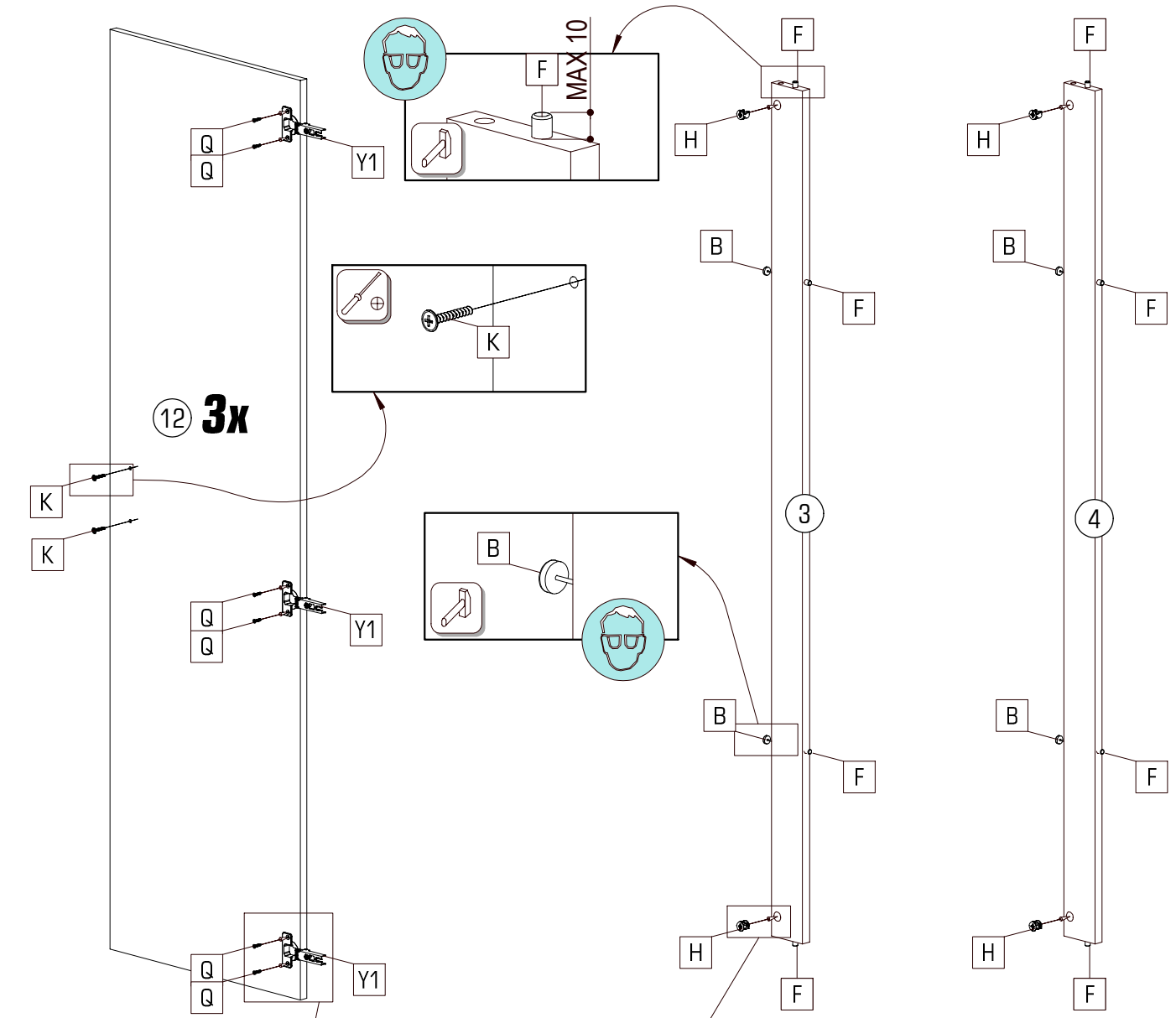

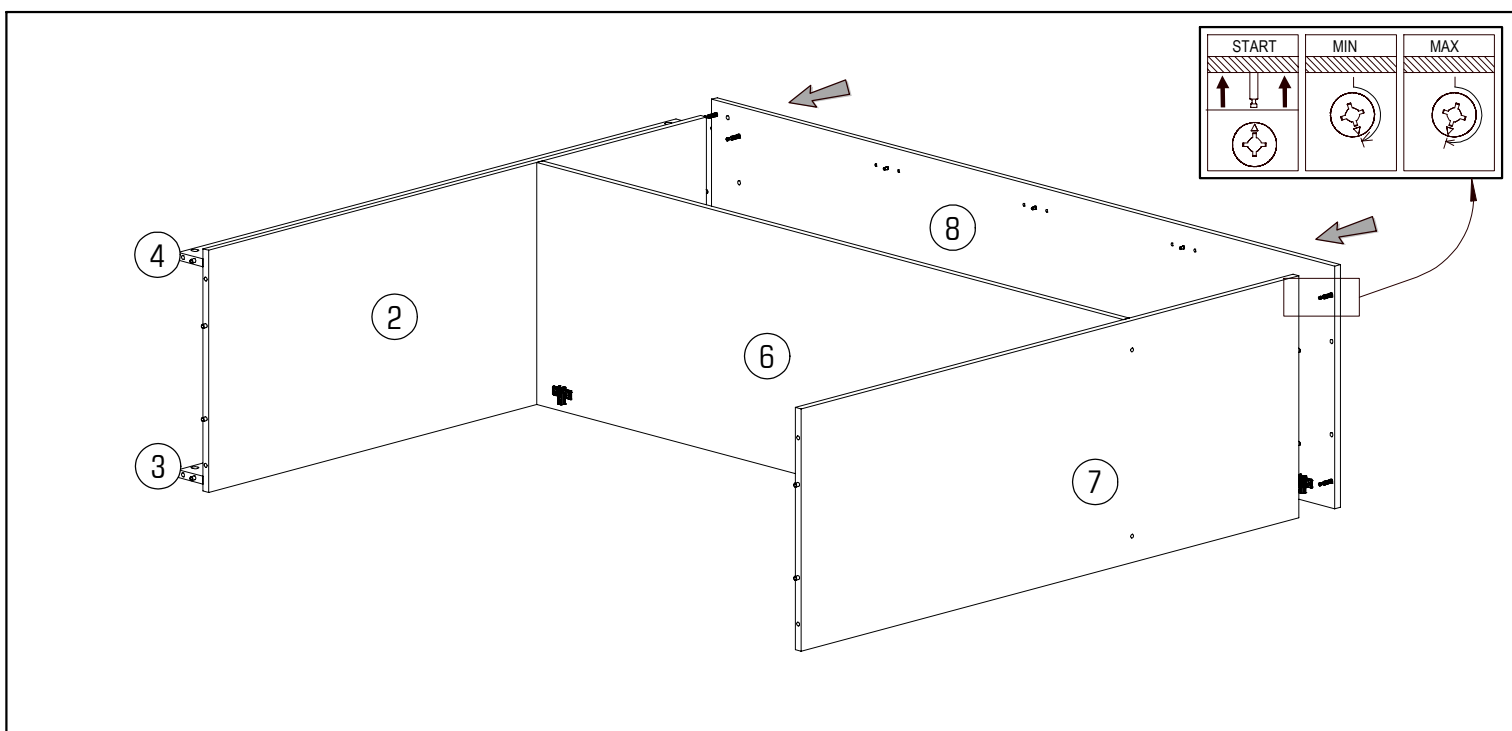
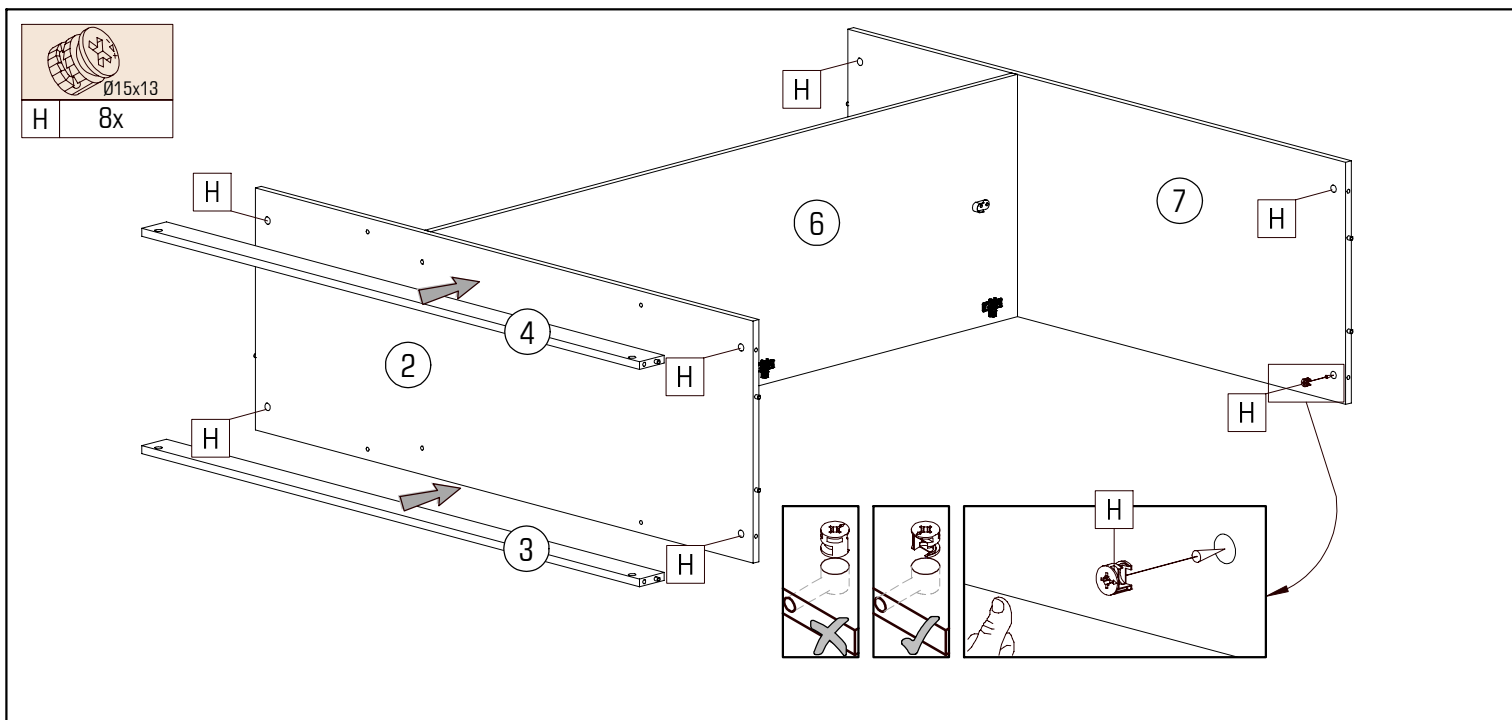
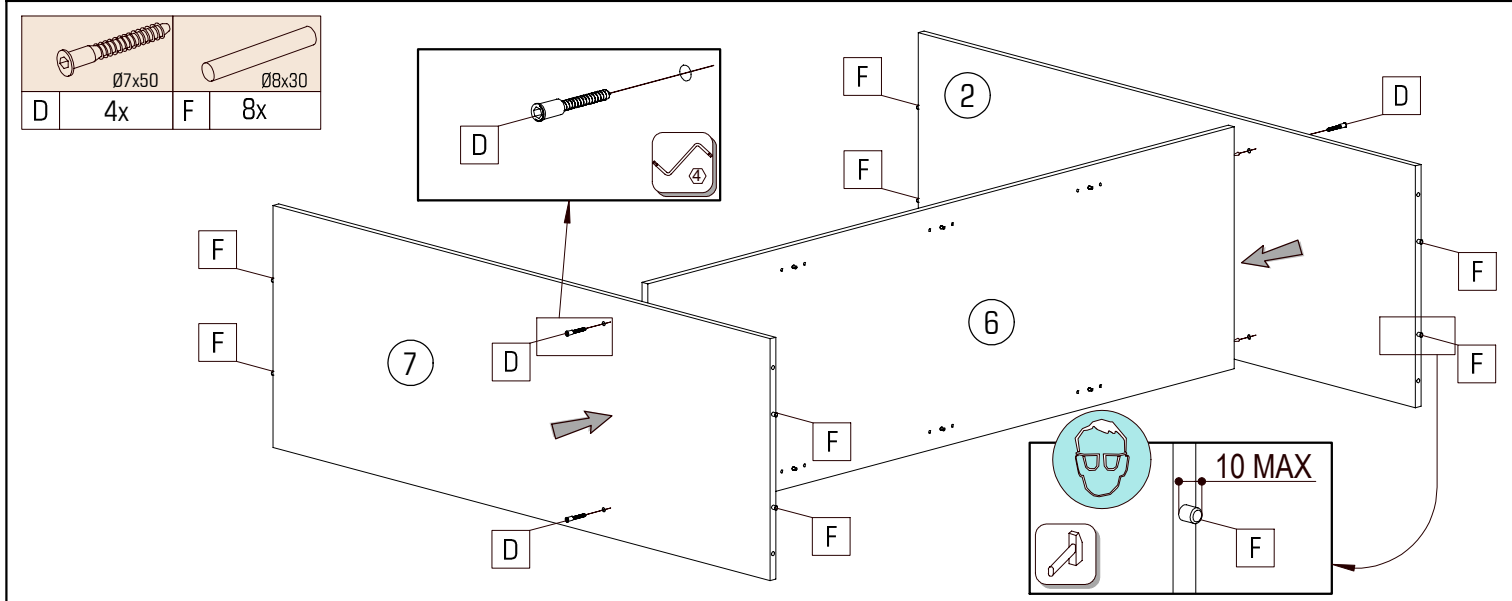

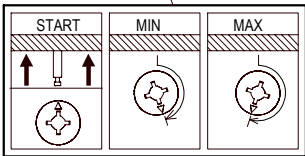
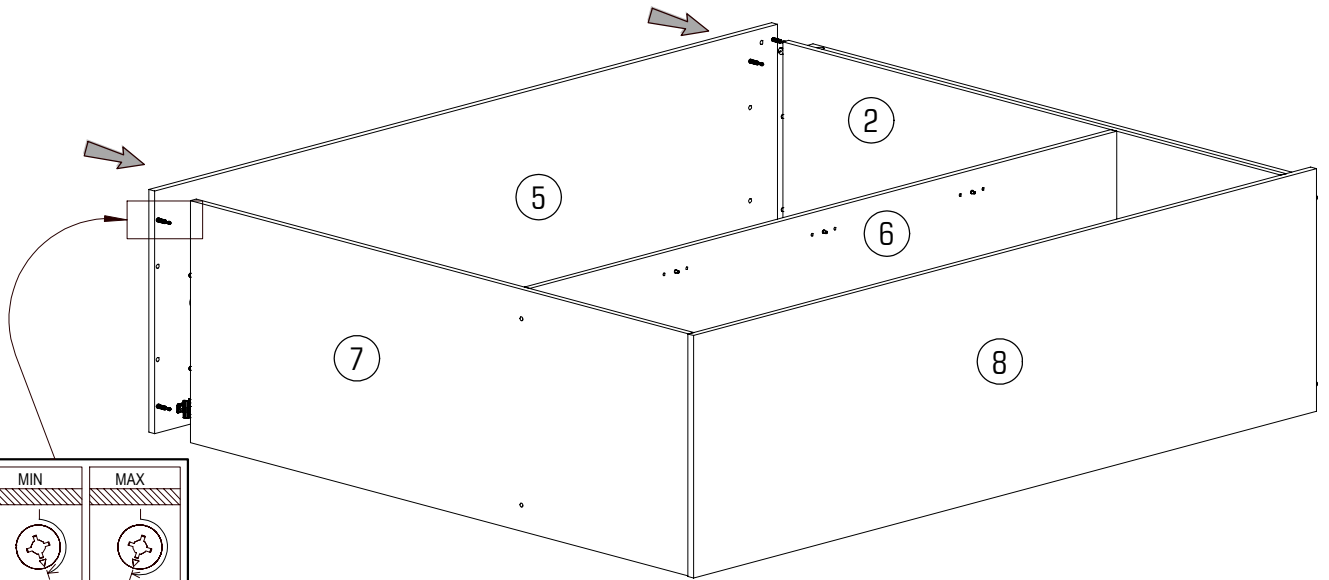



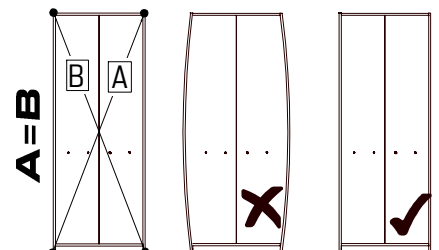
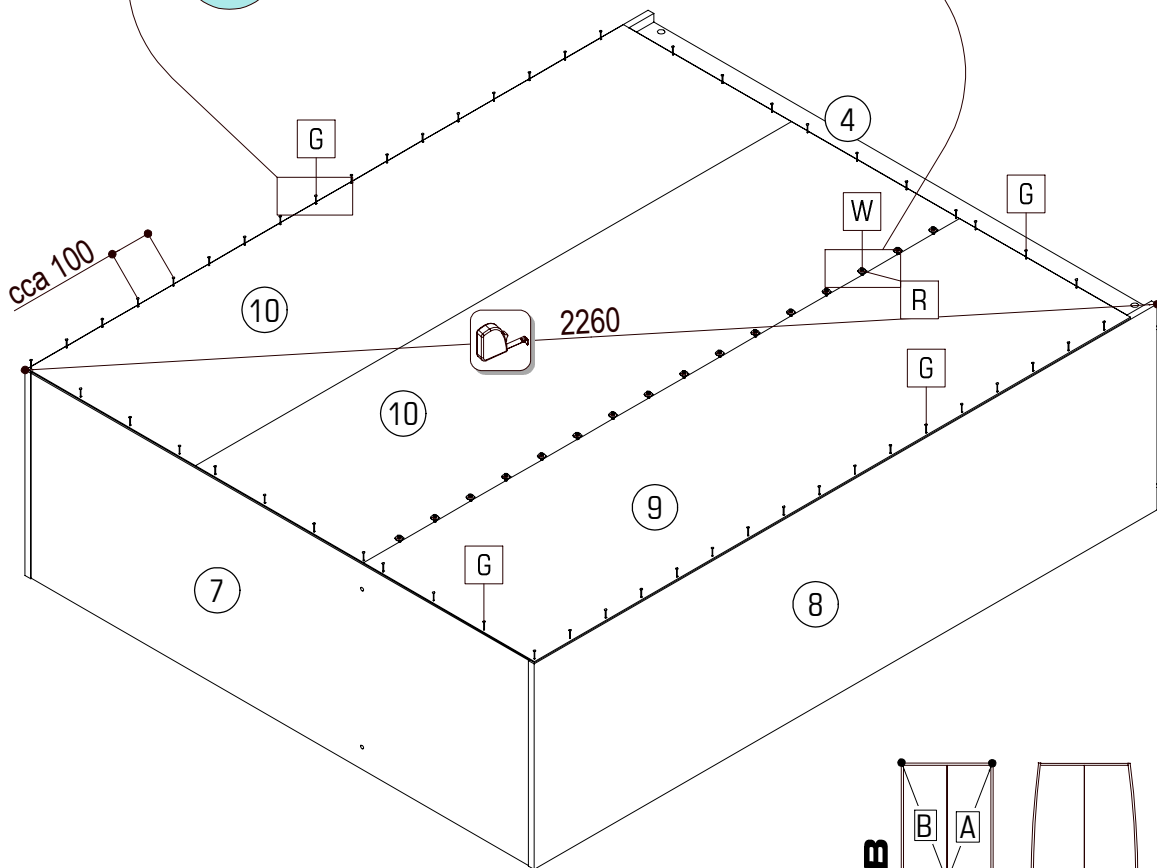
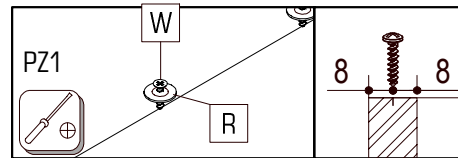
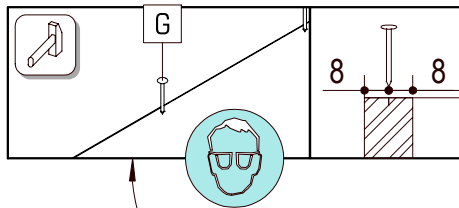

Ø1.6x20	3.0	Ø2.5x16
G 50x	R 16x	W 16x

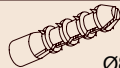

				
Ø3,5x16		Ø8	Ø4x70	
A	2x	N	4x	P
				1x
				1x

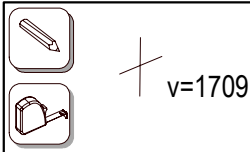

1.

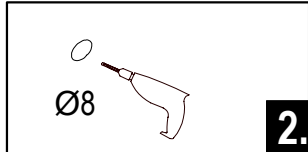

2.

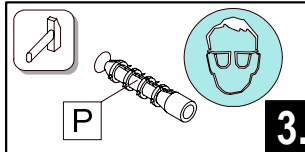

3.

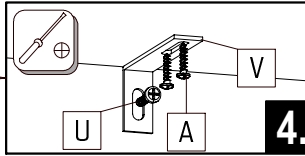

4.

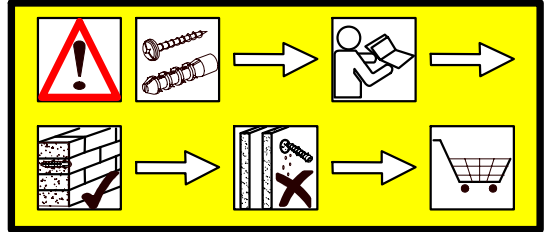
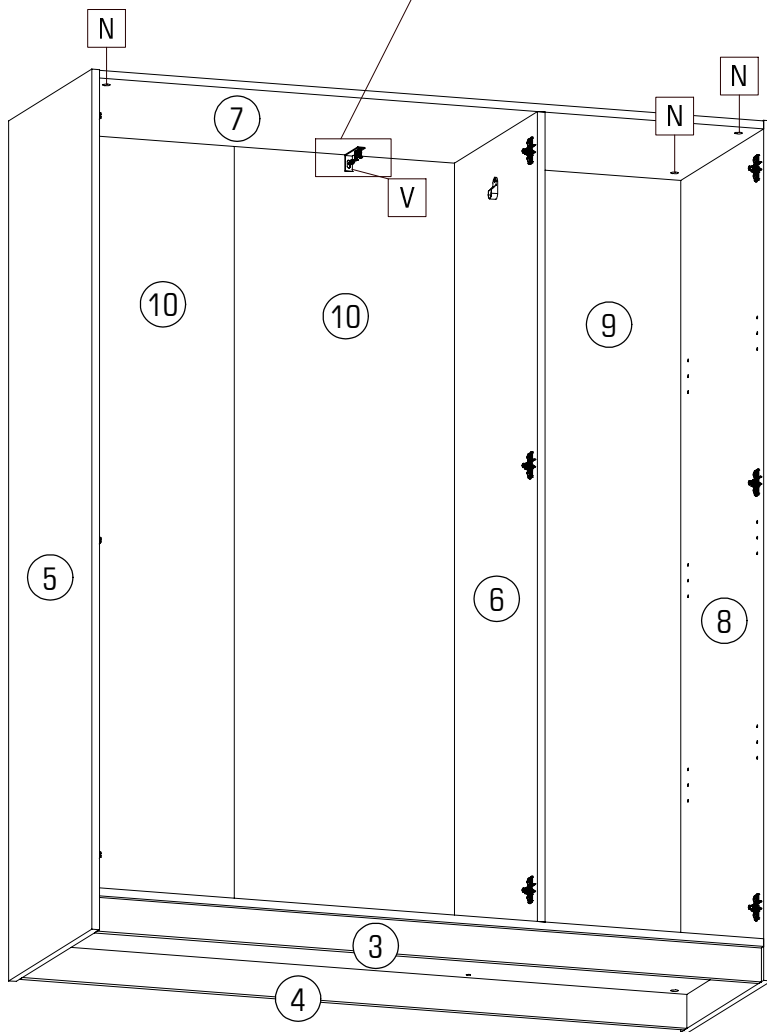

Upozornenie! Pevnosť steny sa musí pred montážou bezpodmienečne skontrolovať. Univerzálne hmoždenky, ktoré sú obsiahnuté v balení, používajte jedine pre pevné murivo ako je betón/tehla. Hmoždenky sa nesmú používať v prípade ľahkého staveného muriva, dutina tehla, u sádrokartónových dosiek alebo iných konštrukcií rámu. U týchto murív je nutné použiť špeciálne hmoždenky! Tieto je možné dostať v špeciálnych predajniach so stavebným materiálom (stavebniny). Pri nedodržaní pokynov nepreberajú výrobcovia/predajci a dodávateľa zodpovednosť za vzniknuté škody.

Upozornění! Před montáží je nutné zkontrolovat stav stěny. Přiložené univerzální hmoždinky jsou určeny pouze k použití pro pevné zdivo jako beton/cihly. Hmoždinky do zdi se nesmí používat u dutinová cihla, zdiva jako pórovitý stavební kámen, sádrokartónová deska nebo jiný měkký materiál. U těchto zdiv jsou nutné použít speciální hmoždinky! Jsou k dostání v speciálních prodejních se stavebním materiálem. Při nedodržení těchto pokynů výrobce/prodejce a dovozce neručí za způsobené škody.

Pažnja! Prije montaže obvezno provjerite svojstvo zida. Priložene univerzalne tiple namijenjene su isključivo za masivne zidove od betona/opeke. Tiple za masivne zidove ne smiju se koristiti za zidove kao npr šupljina opeka laki sastavni elementi, gips-kartonске ploče ili drugi modularni načini gradnje. Za te zidove potrebno su eventualno specijalne tiple! Iste su dostupne u specijaliziranim trgovinama građevinskim materijalom. U slučaju nepridržavanja prethodno navedenih napomena, proizvođač/trgovac i uvoznik ne preuzimaju odgovornost!

Achtung! Die Wandbeschaffenheit ist vor der Montage unbedingt zu prüfen. Die beigelegten Universaldübel sind ausschließlich nur zur Verwendung für festes Mauerwerk wie Beton/Ziegel. Die Mauerdübel dürfen nicht bei Mauerwerk wie Hohlraumziegel, Leichtbausteinen, Gipskartonplatte oder anderer Rahmenbauweise verwendet werden. Bei diesen Mauerwerken sind gegebenenfalls Spezialdübel zu verwenden! Diese sind in einem Fachgeschäft (Baumarkt) erhältlich. Bei Nichteinhaltung wird seitens Produzenten/Händler und Importeur keine Haftung übernommen.

Vigyázat! Szerelés előtt a falfelületet feltétlenül vizsgálja meg. A mellékelt univerzális tiplé kizárólag stabil falazathoz használható mint például beton/tégla. A fali tiplé nem használható könnyű építőkövek hez, üreg tégla, gipszkarton lapokhoz vagy más fávázás építményekhez. Ezekhez a falfelületekhez csak speciális tiplik használhatóak, melyek szaküzletekben (barkácsruházakban) beszerezhetőek. Fentiek figyelmen kívül hagyása esetén a gyártó/kereskedő vagy forgalmazó nem vállal felelősséget.

Uwaga! Ścianę należy sprawdzić przed montażem. Dołączone uniwersalne kolki rozporowe są odpowiednie tylko do stosowania w mocnych murach, takich jak beton lub cegła. Nie rób za pomocą kółków rozporowych murowanych, takich jak pustak, lekka kostka, powierzchnie takie jak płyty gipsowo-kartonowe lub inne systemy ram. Jeśli dotyczy, muszą to być określone kolki rozporowe być użytych! Są one dostępne w specjalistycznym sklepie (sklepie ze sprzętem) niezgodność, producent / sprzedawca lub importer nie ponoszą odpowiedzialności.

Prudentă! Zidul trebuie examinat înainte de asamblare prizele de perete sunt adecvate numai pentru utilizarea în zidărie fermă, cum ar fi betonul bloc sau cărămida. Nu folosiți zidăria zidurilor de perete, cum ar fi cărămida goală, blocul ușor, suprafețe cum ar fi gips-carton sau altă încadrare sisteme. Dacă este cazul, trebuie folosite anumite prize de perete! Acestea sunt disponibile la un magazin specializat (magazin de hardware). În caz de nerespectare, producătorul / vânzătorul cu amănuntul sau importatorul nu își asumă răspunderea.

Увага! Стан стіни необхідно перевірити перед установкою. Укладені універсальні дюбелі призначені лише для використання з фіксованими Кладка, як бетон / цегла. Анкери для стін не повинні використовуватися для кладки Порожни цегли, легкі будівельні блоки, гіпсокартон або інша каркасна конструкція бути використаними. З цією кладкою можуть застосовуватися спеціальні дюбелі використанні! Вони доступні в спеціалізованому магазині (магазині апаратних засобів) Виробник / дилер та імпортер не несе відповідальності.

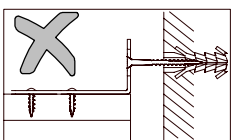
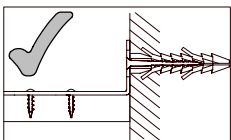
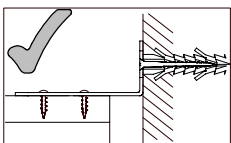

	L=914
T2	1x

