



GRIFON

A		1
B	 Prawy/Right	4
C	 M6x20 mm Lewy/Left	12

①

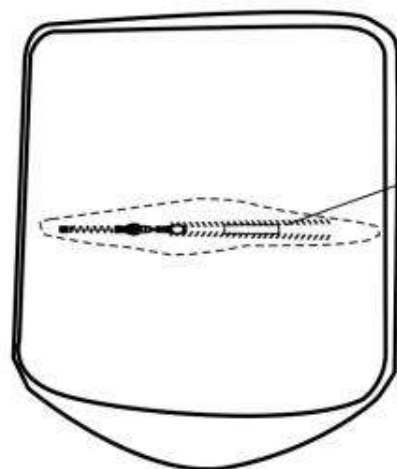

②

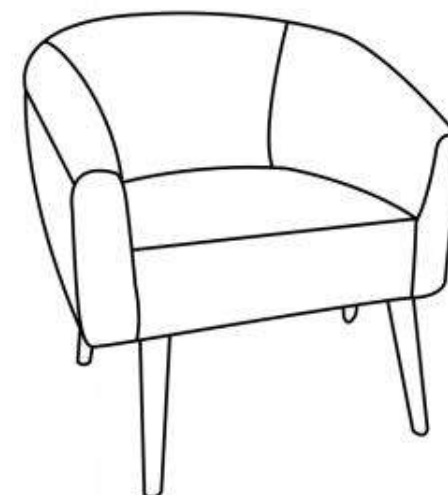
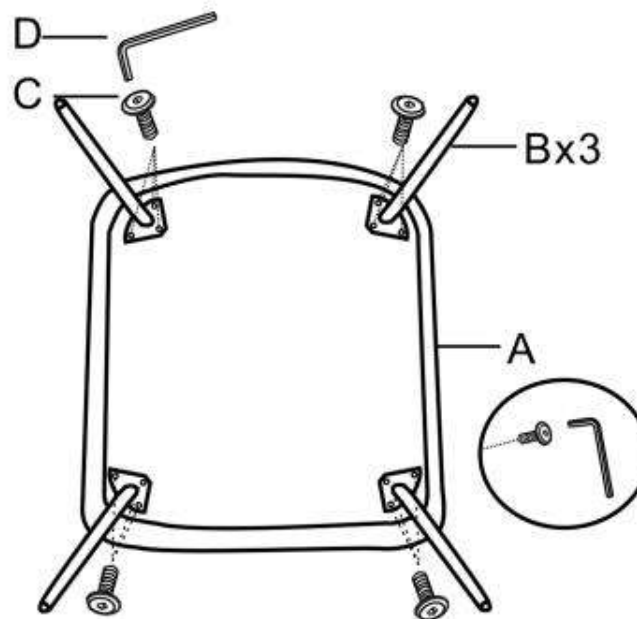
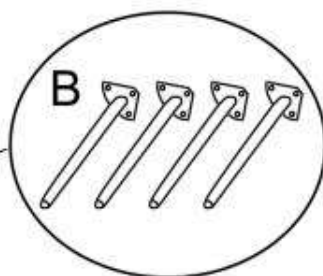

 max. 100 kg

v.1

HALMAR Sp. z o.o.

ul. Centralnego Okręgu Przemysłowego 2, 37-450 Stalowa Wola, POLSKA / POLAND
tel. +48 15 843 28 10, fax: +48 15 842 19 57, e-mail: office@halmar.com.pl

NOWOŚĆ