

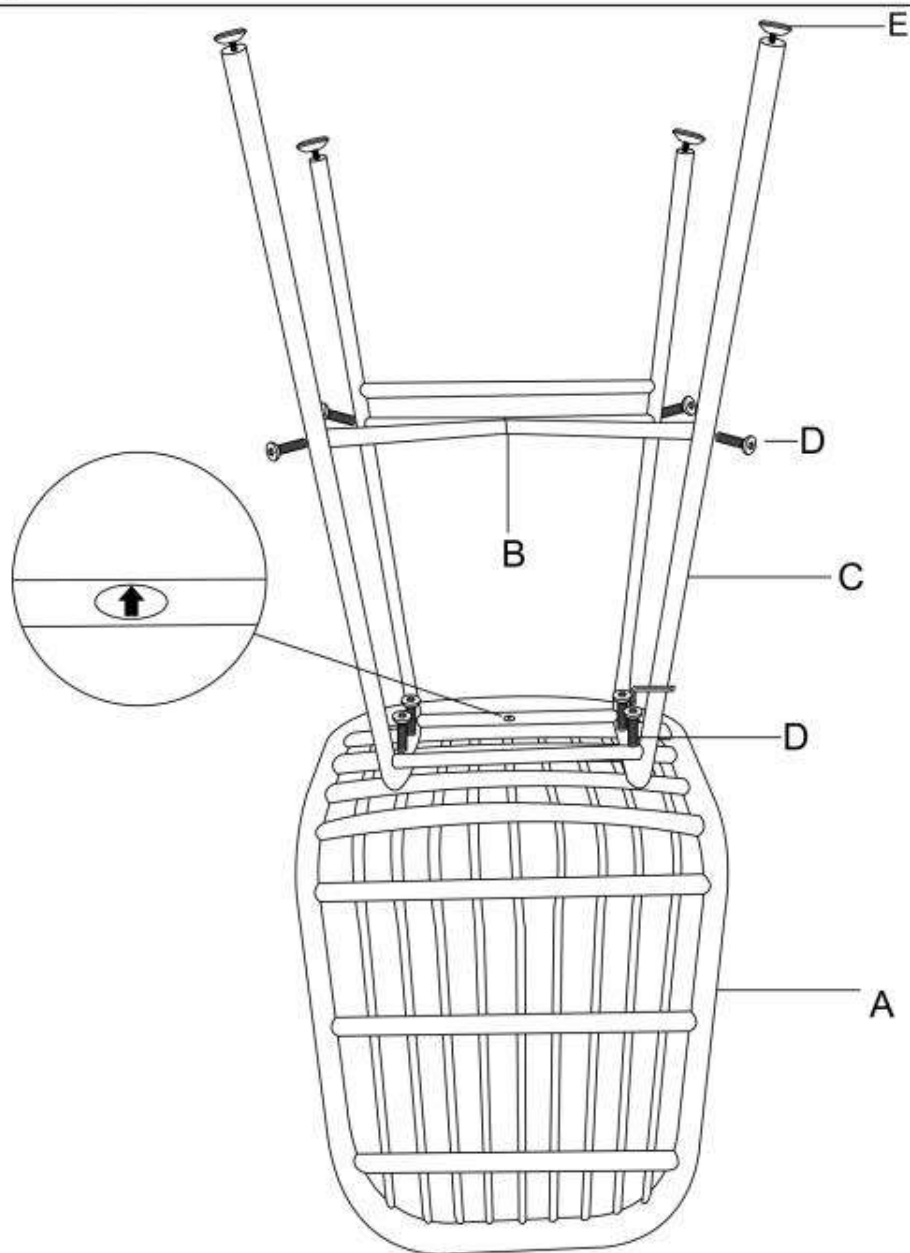





# H/97



A		1
B		1
C		1
D		8
E		4



 max. 100 kg

v.1