

# K469

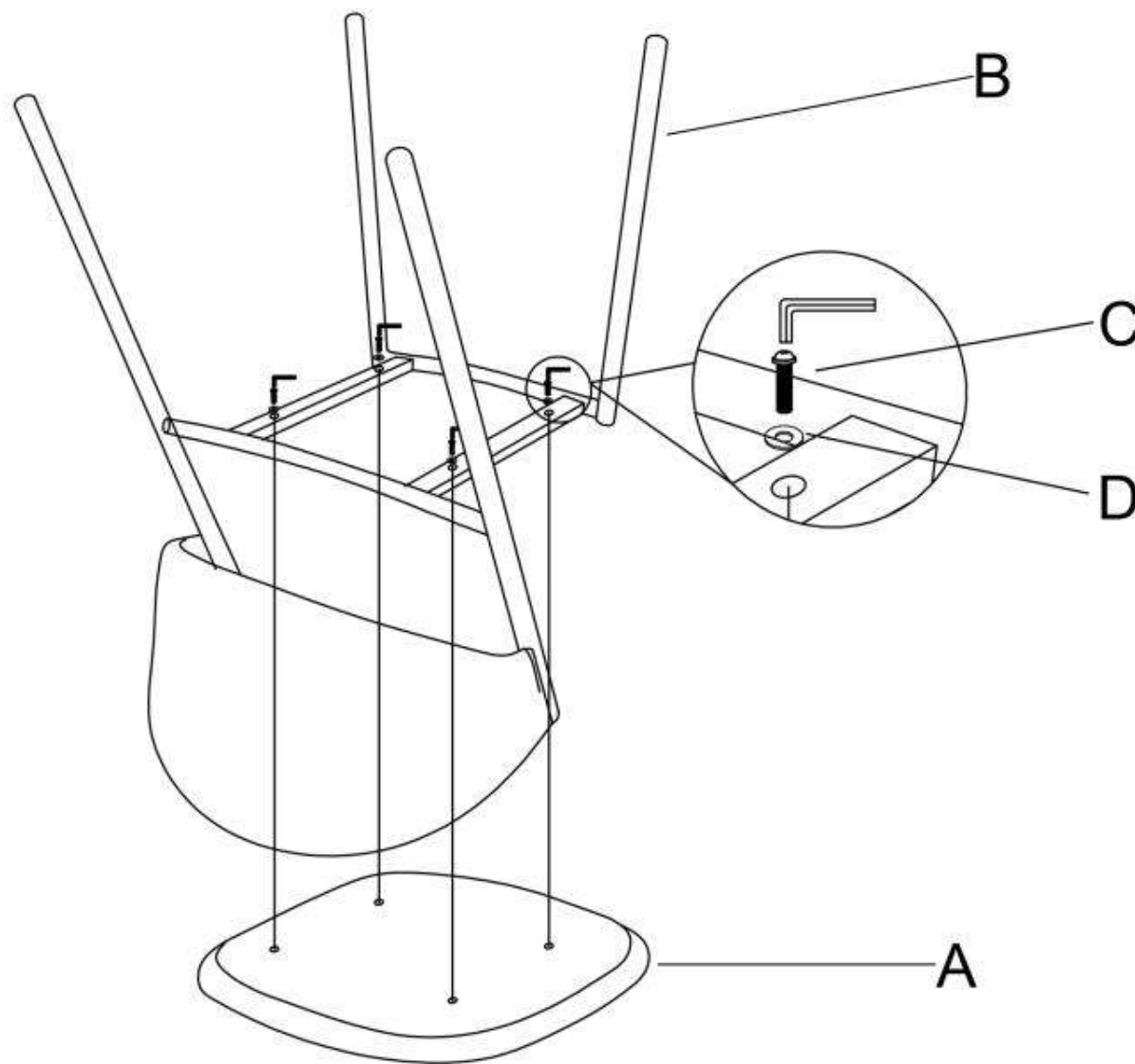

A		1
B		1
C		4
D		4

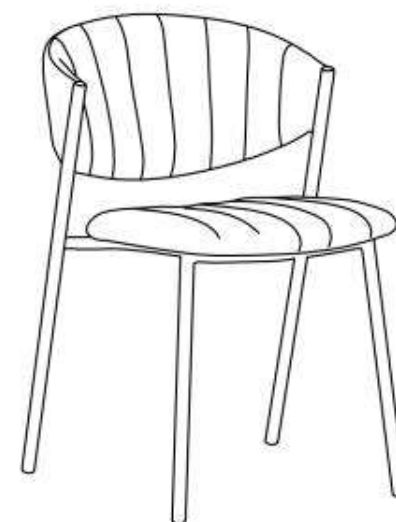

max. 100 kg

v.1