

# KOLI C-1

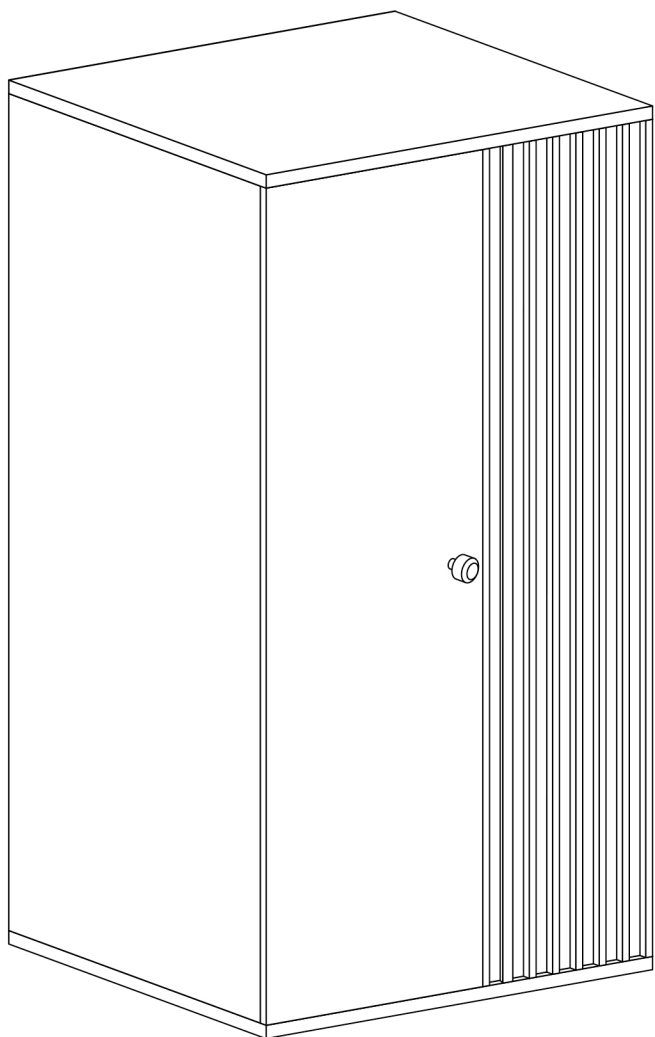

1	1836	560	16	1
2	1836	544	16	1
3	864	580	32	1
4	864	580	32	1
5	1836	560	16	1
6	452	560	16	2
7	342	544	16	3
8	1875	364	2,5	1
9	1875	472	2,5	1
10	1828	484	16	1
11	1828	356	32	1

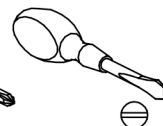
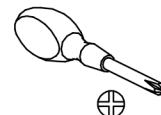
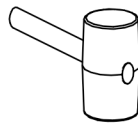
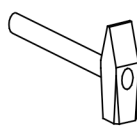
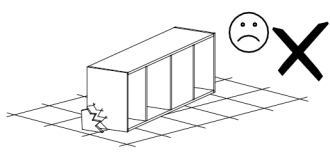
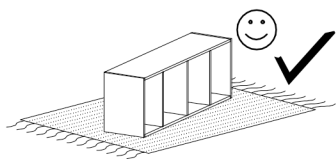
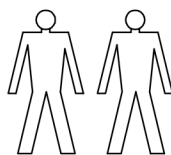
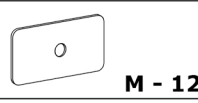
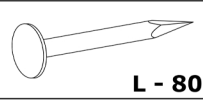
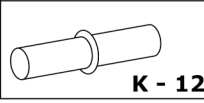
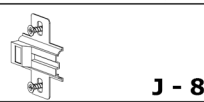
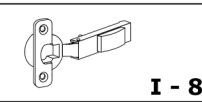
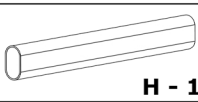
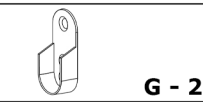
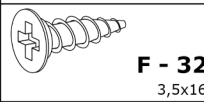
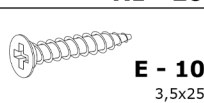
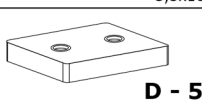
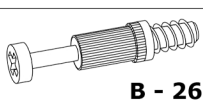
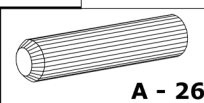
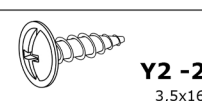
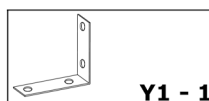
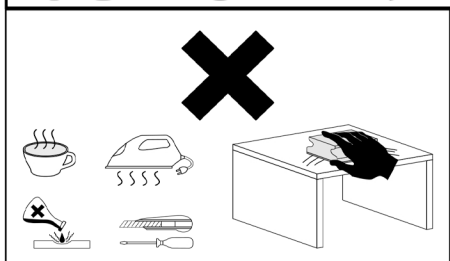
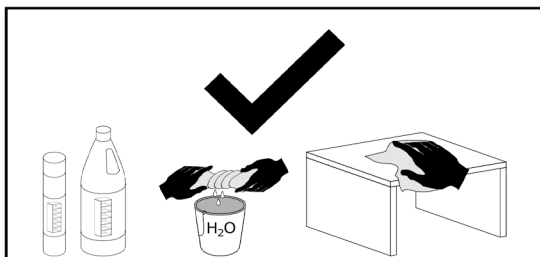
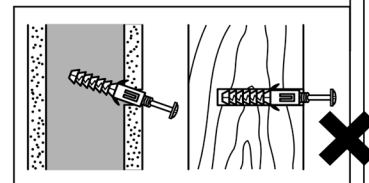
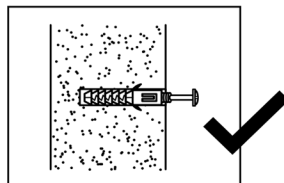
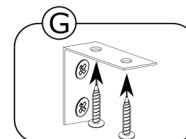
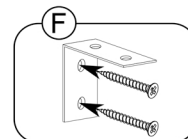
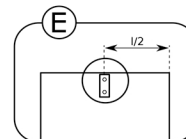
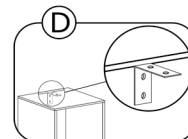
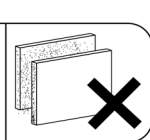
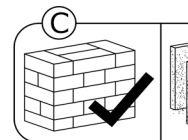
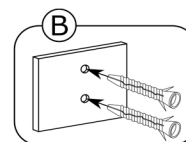
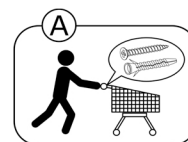
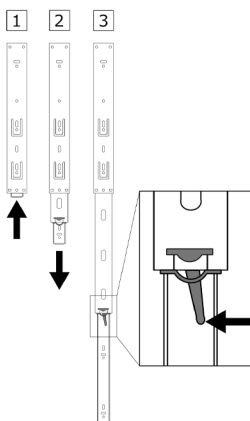

I

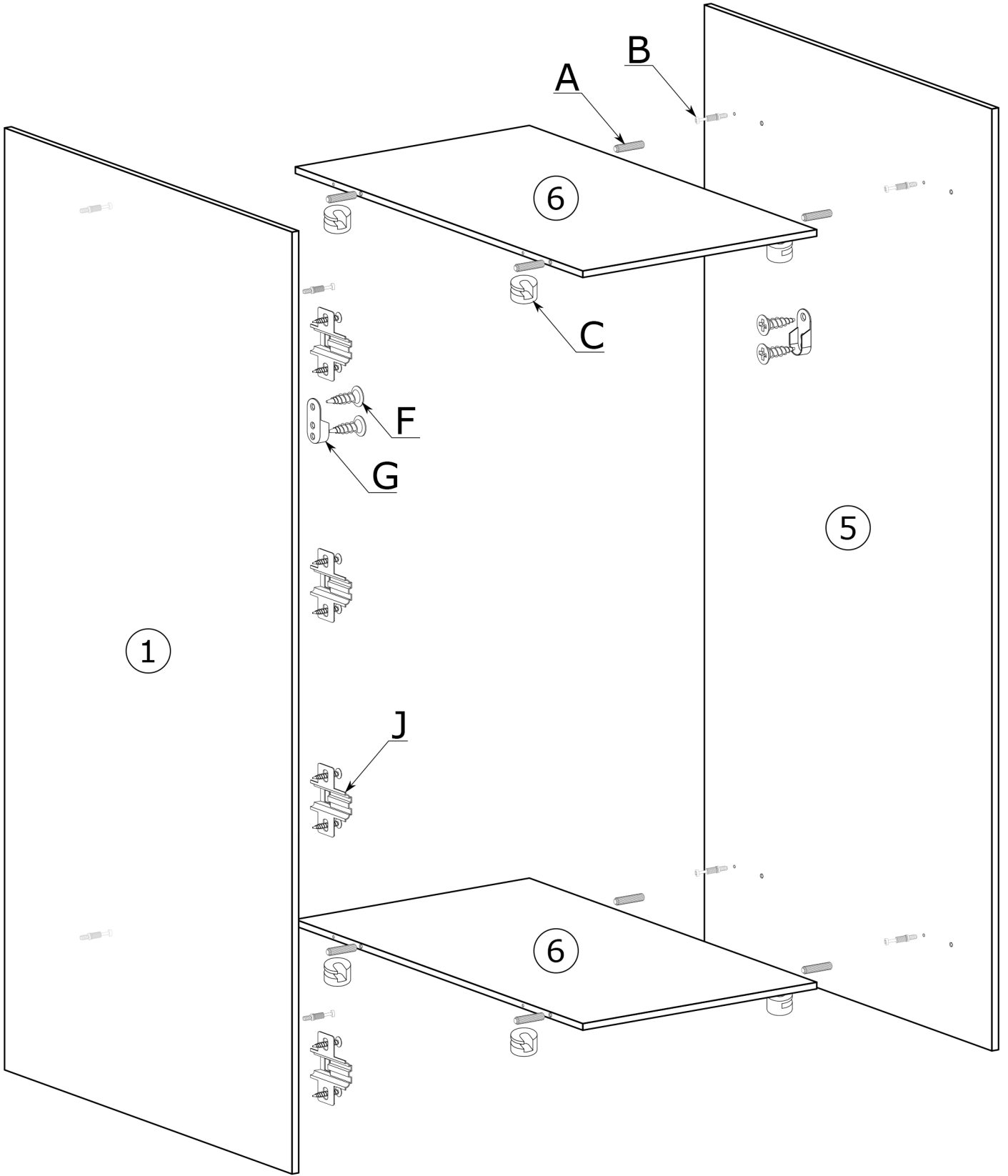

II

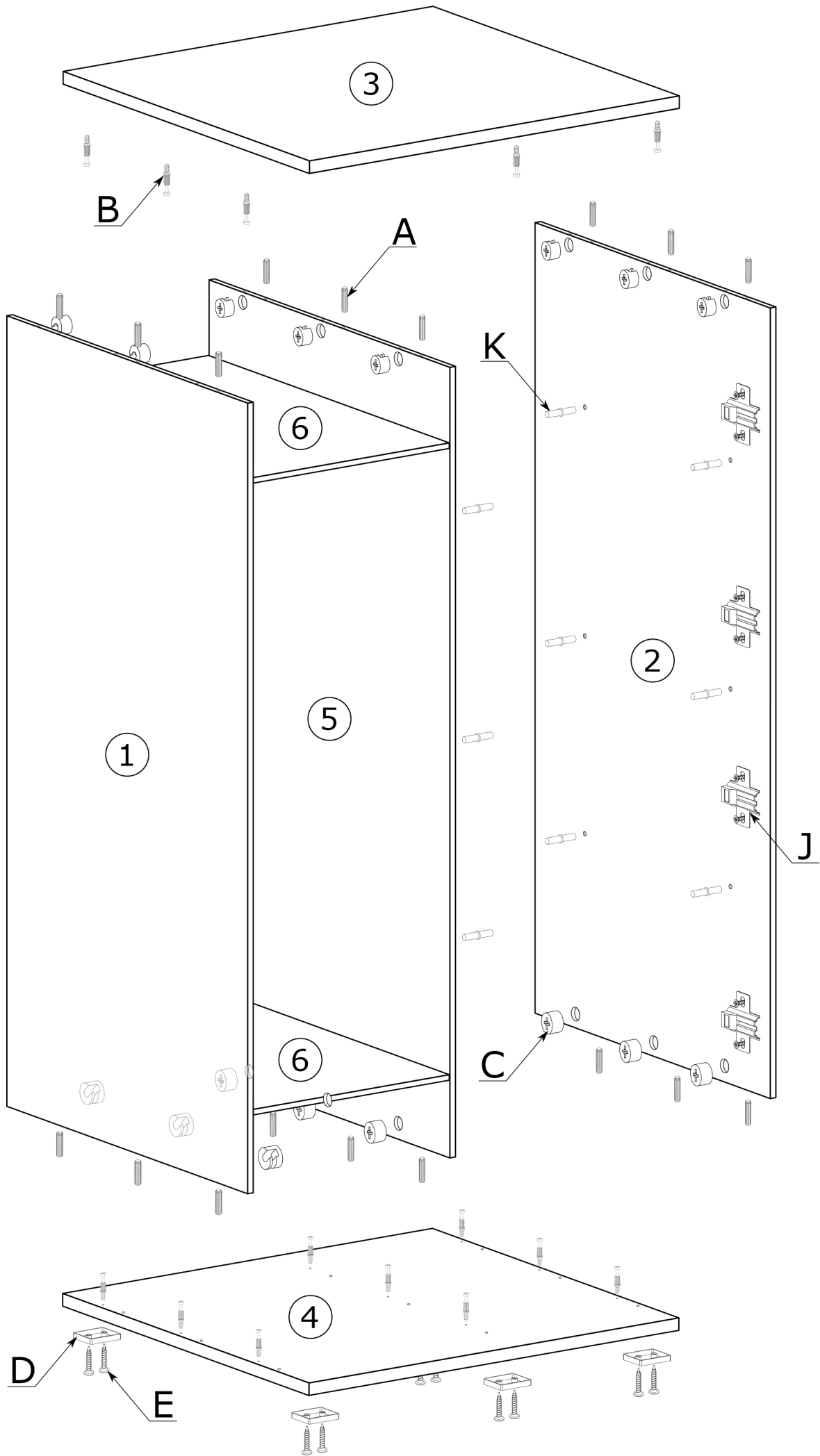

III

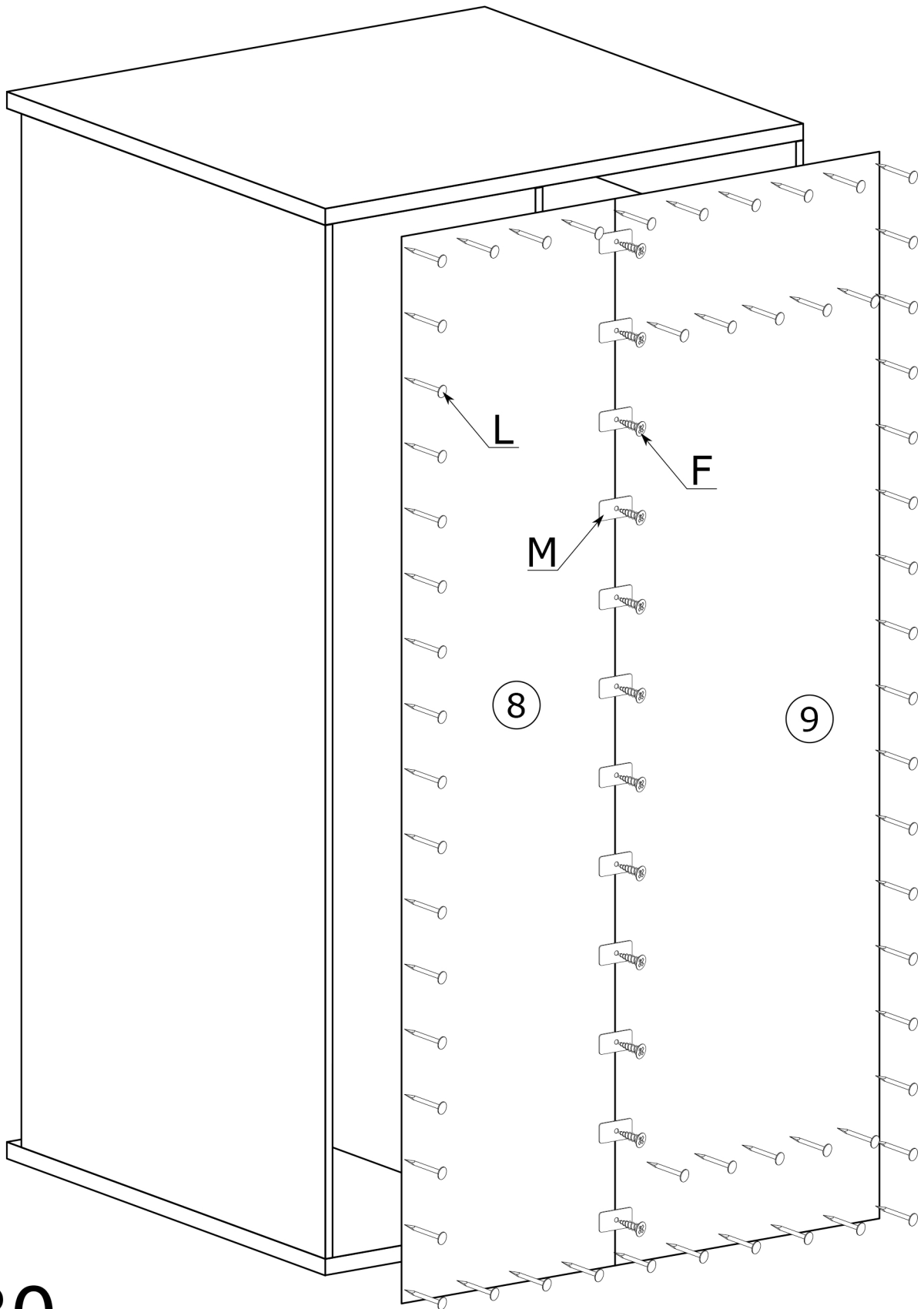

x80

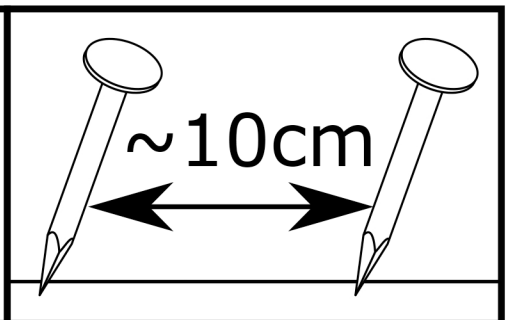
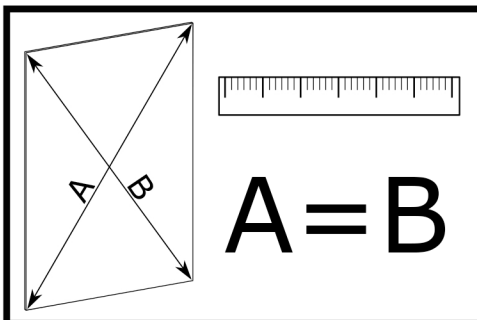
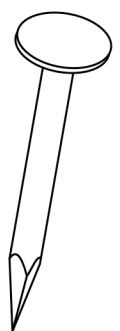

IV

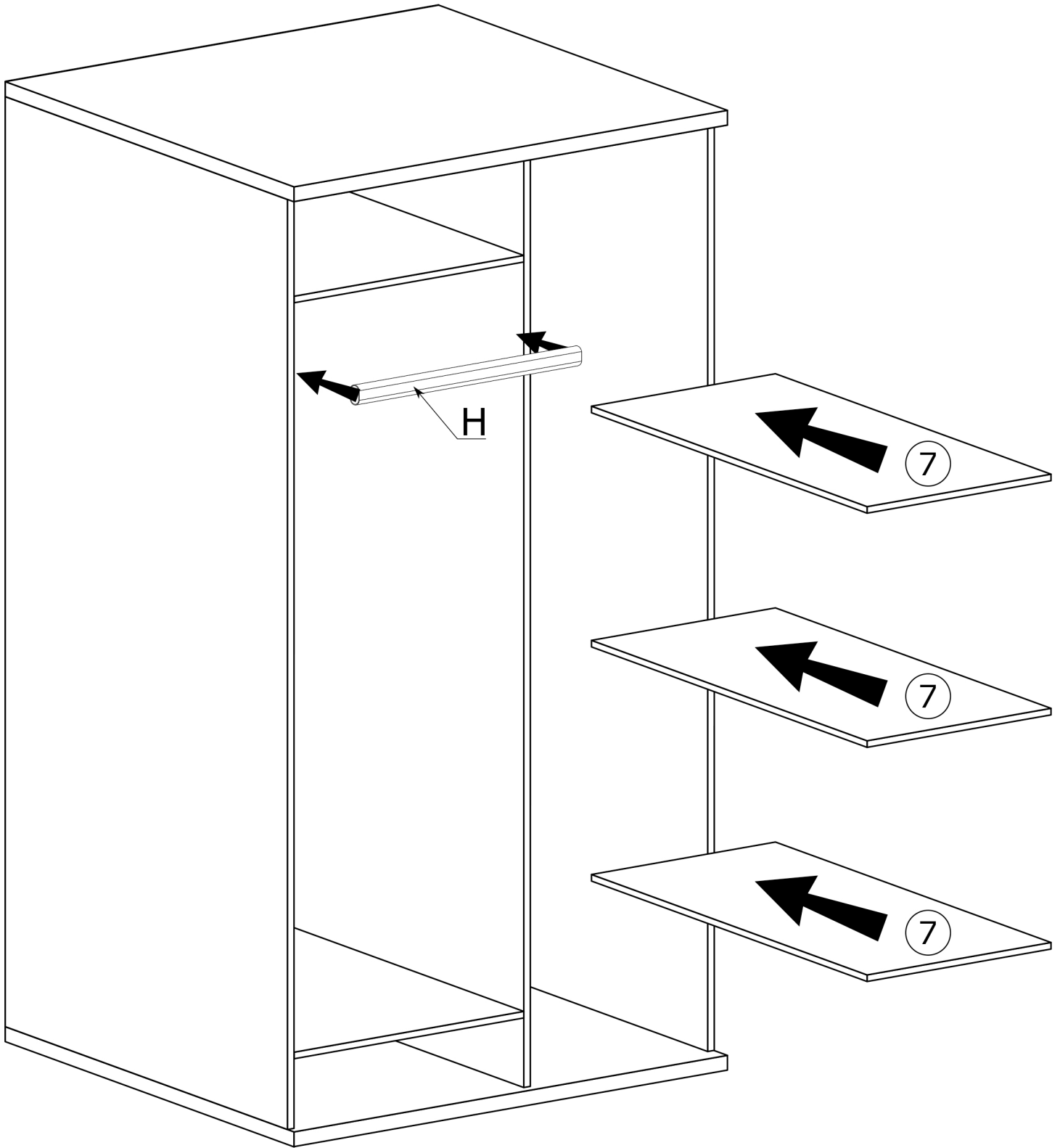

V

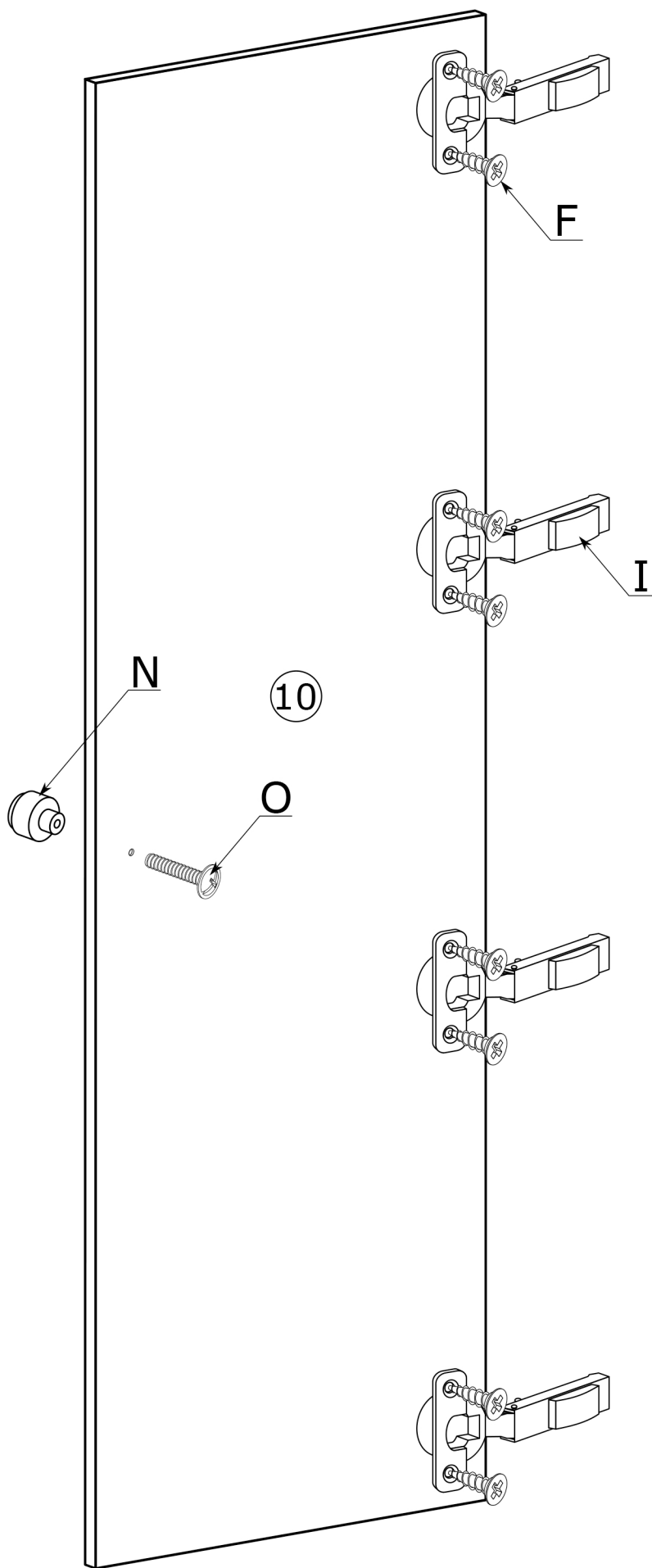

10

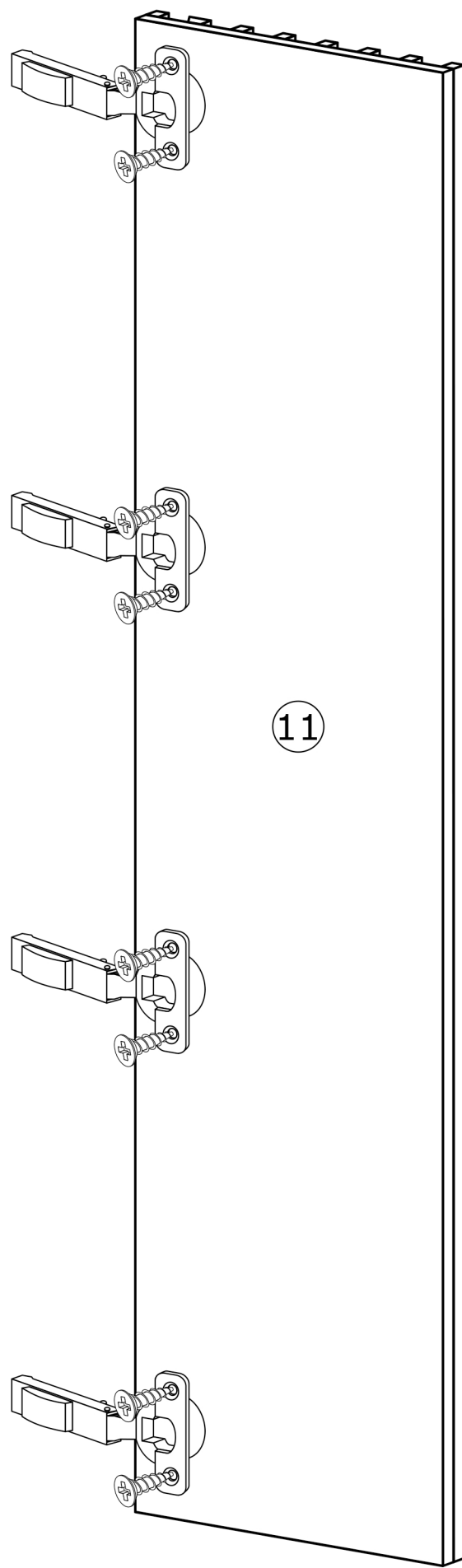

11

VI

