

KOLI C-12

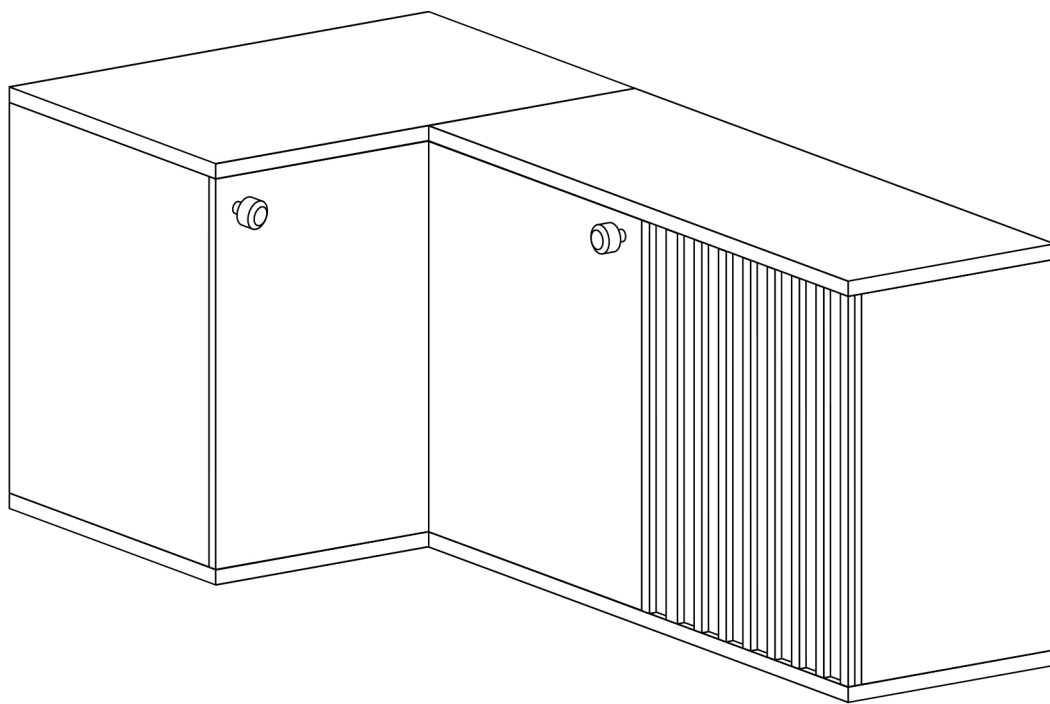

	[mm]	[mm]	[mm]	
1	780	386	16	1
2	780	370	16	1
3	820	406	32	2
4	820	406	32	2
5	780	402	16	1
6	780	120	16	1
7	776	386	16	1
8	796	370	16	1
9	820	816	2,5	1
10	820	802	2,5	1
11	820	300	2,5	1
12	772	402	16	1
13	772	402	16	1
14	772	402	32	1

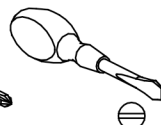
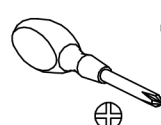
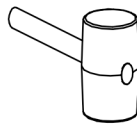
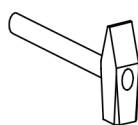
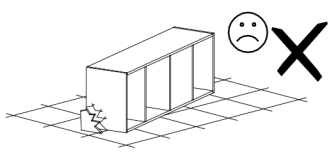
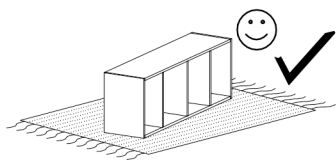
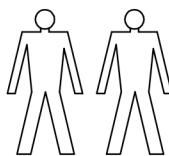

X1 - 24 St.

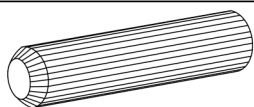

A - 16 St.

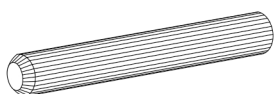

A1 - 6 St.

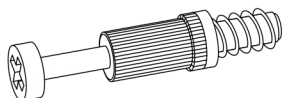

B - 12 St.

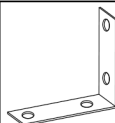

Y1 - 2 St.

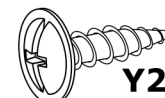

Y2 - 4 St.
3,5x16 mm

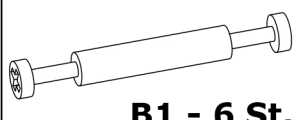

B1 - 6 St.

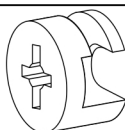

C - 24 St.



D - 8 St.

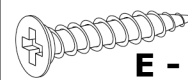

E - 16 St.
3,5x25 mm

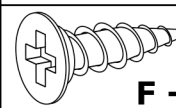

F - 28 St.
3,5x16 mm

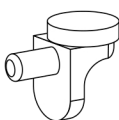

G - 2 St.

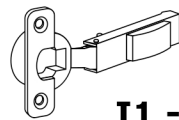

I1 - 2 St.

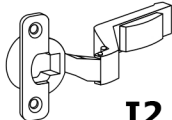

I2 - 2 St.

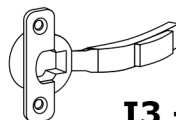

I3 - 2 St.

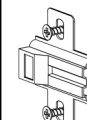

J - 6 St.

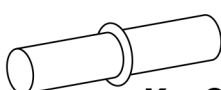

K - 9 St.



L - 60 St.

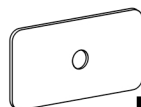

M - 8 St.

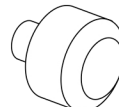

N - 2 St.

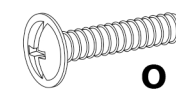

O - 2 St.
3,5x22 mm

I

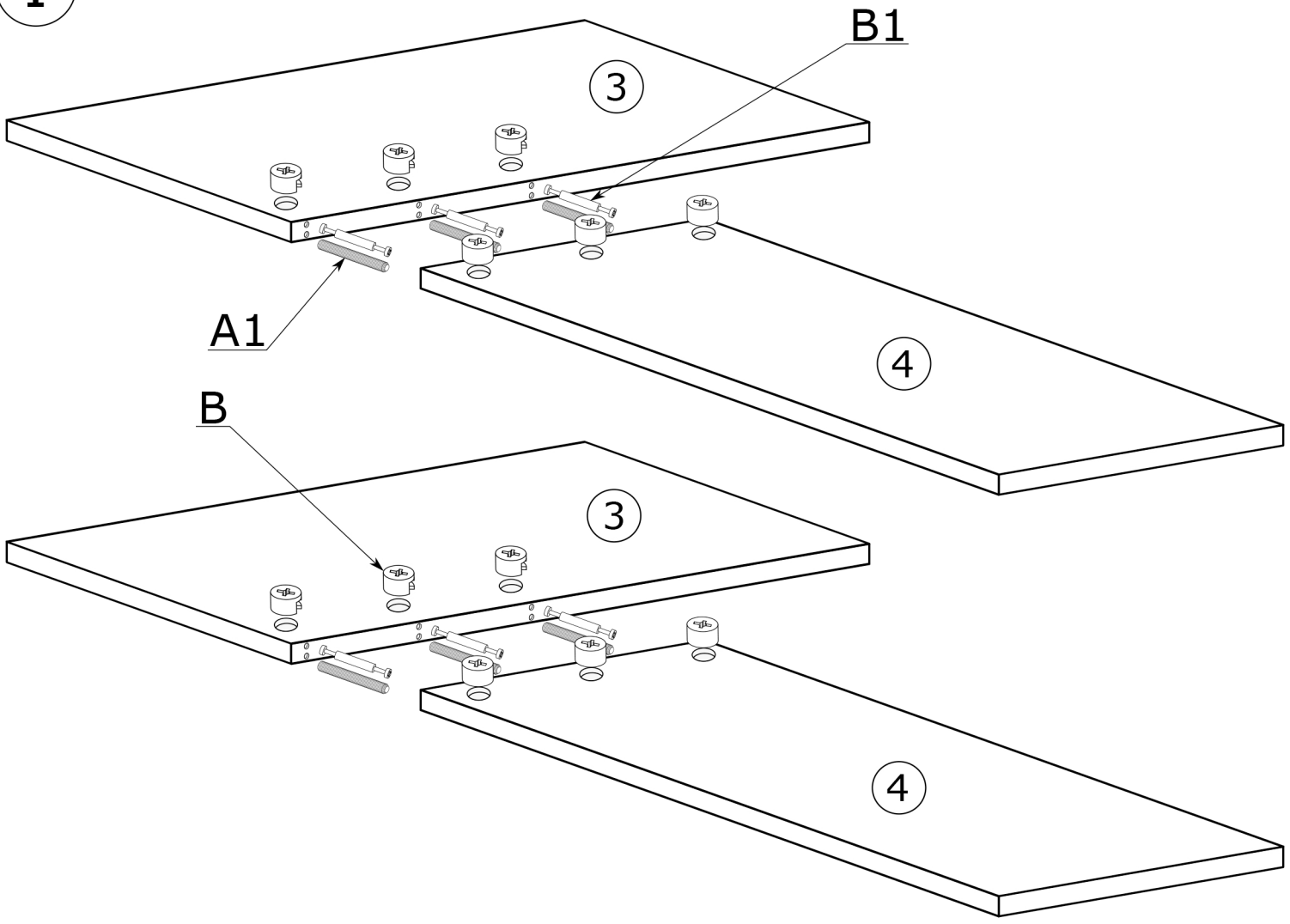

II

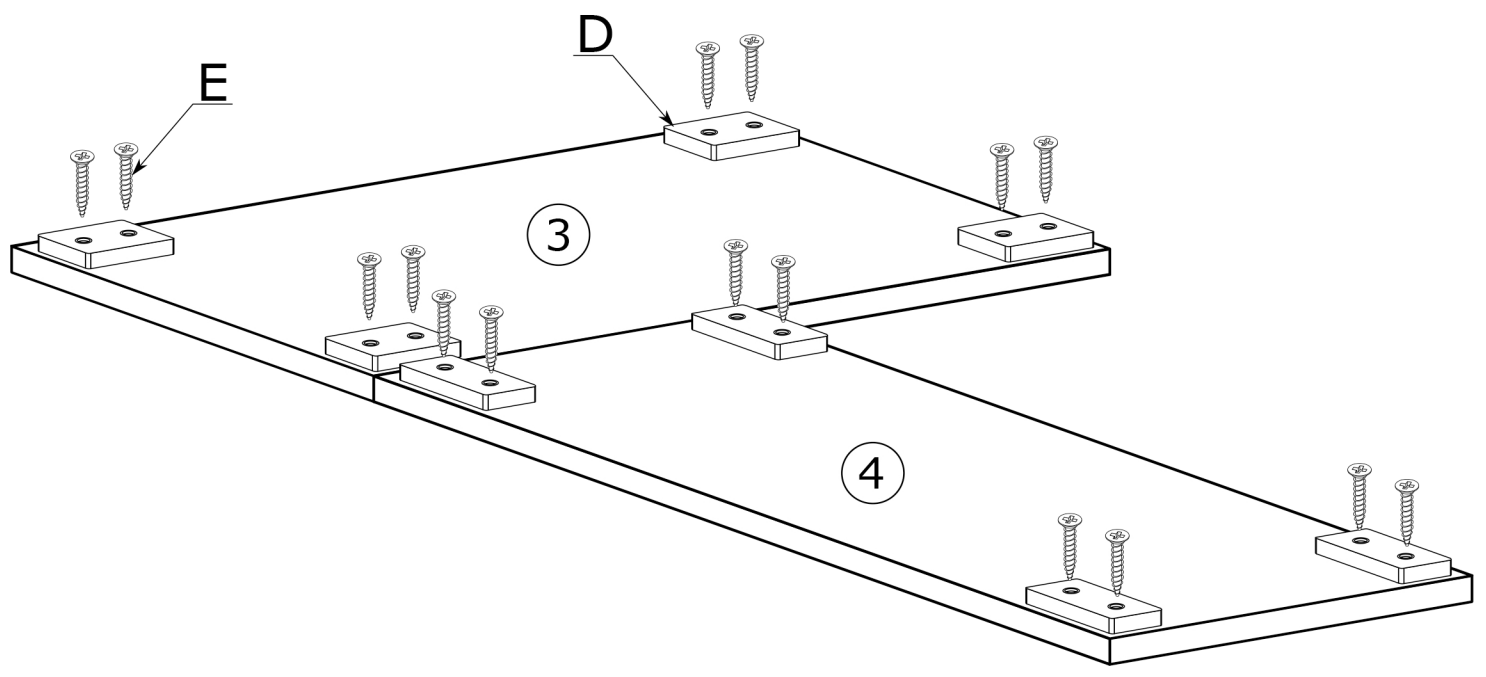

III

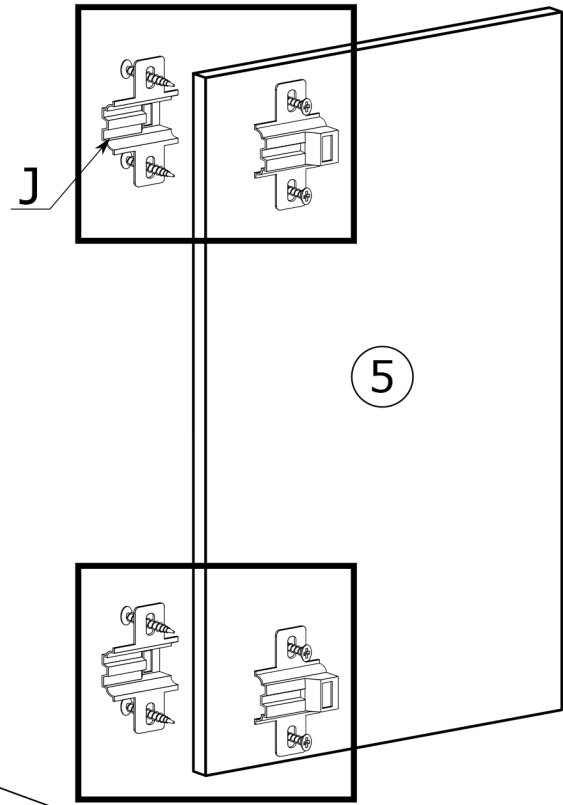
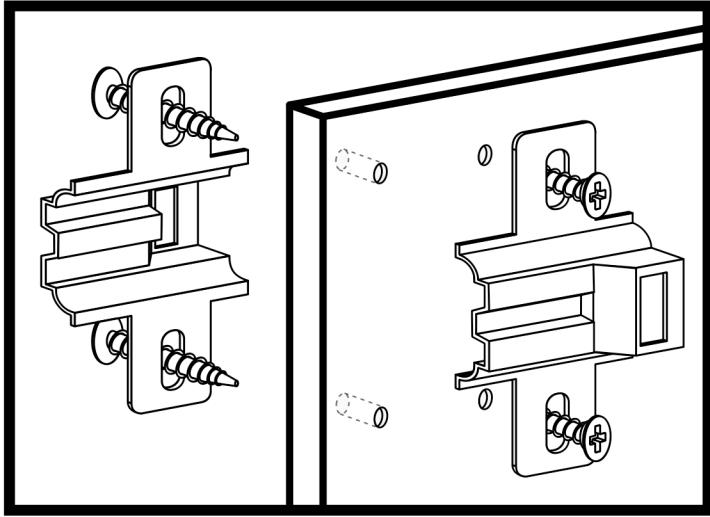

IV

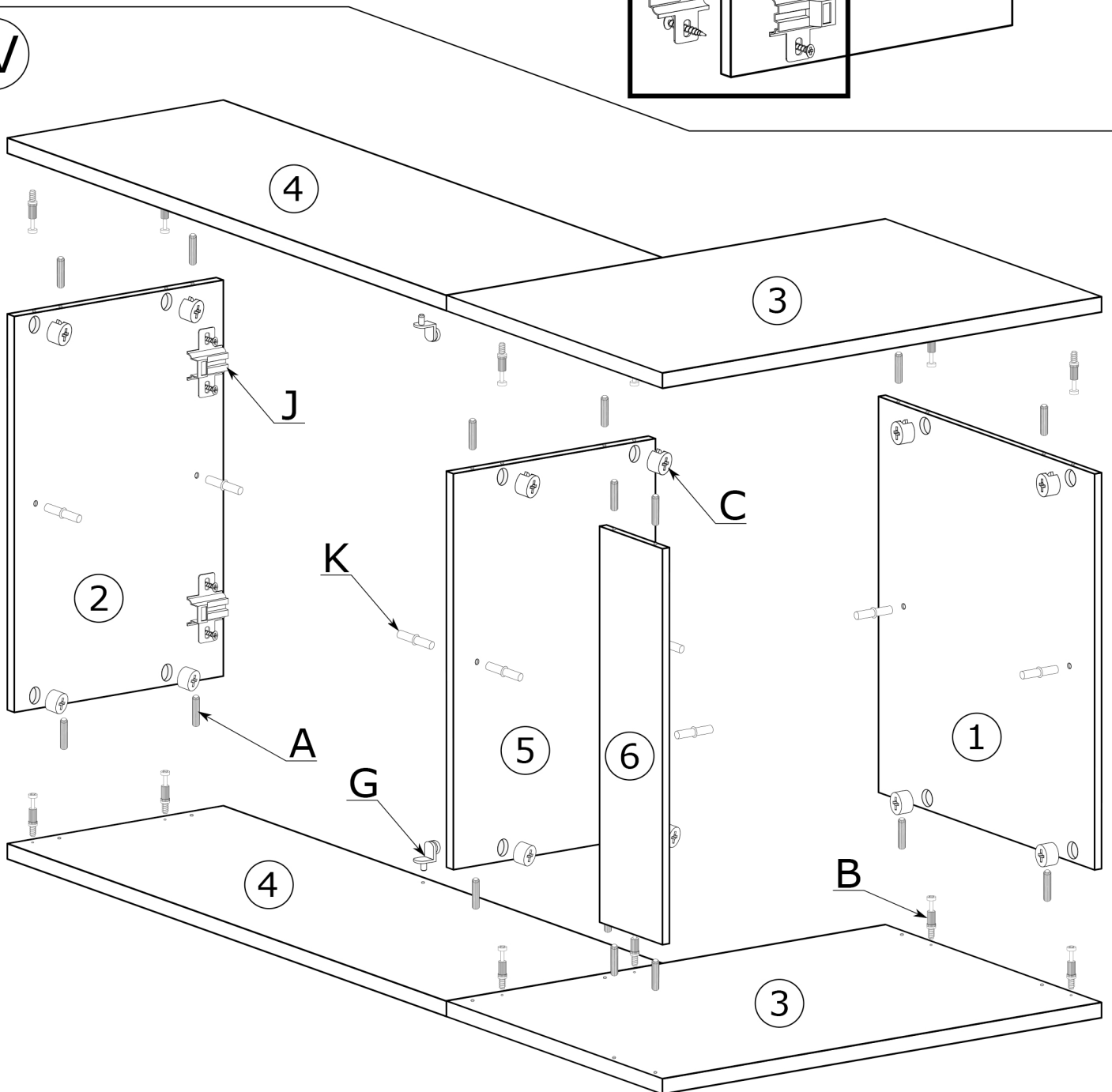

V

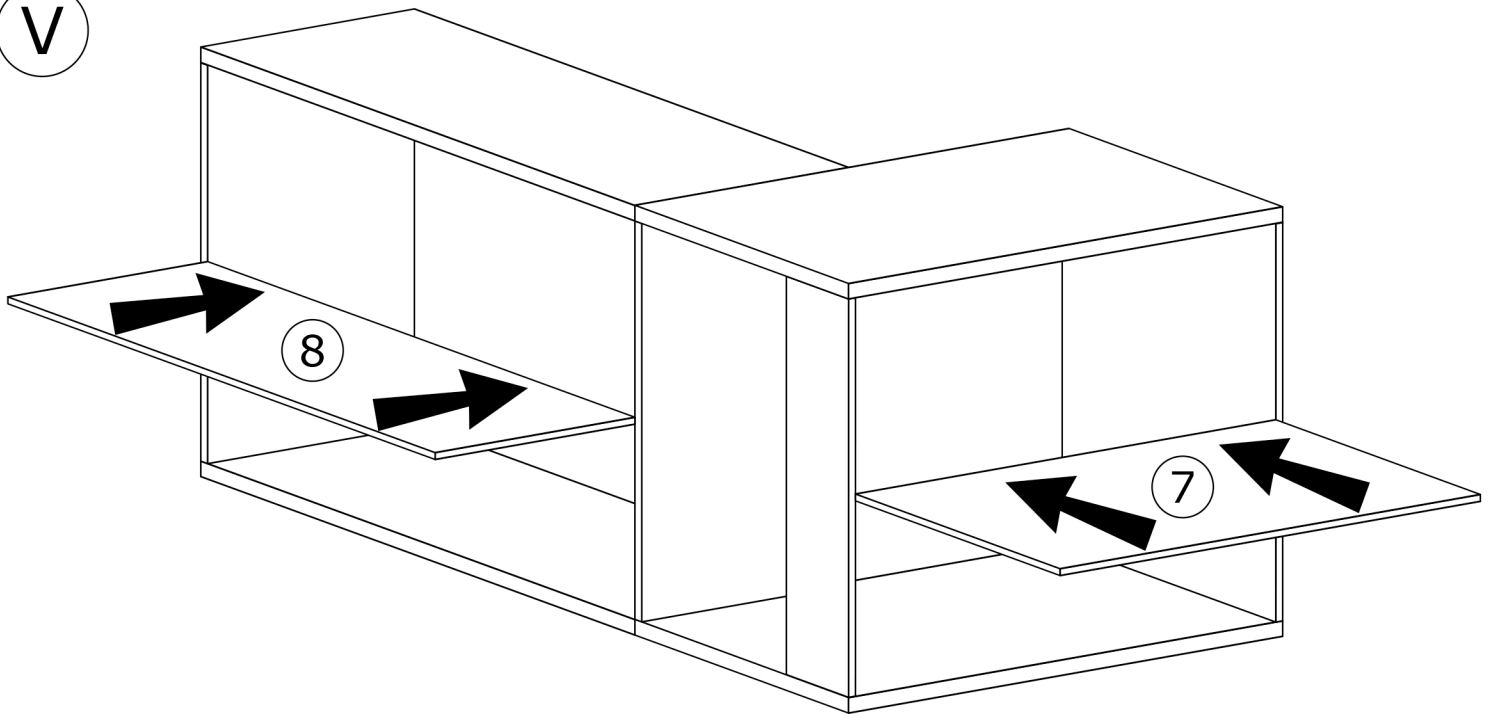

VI

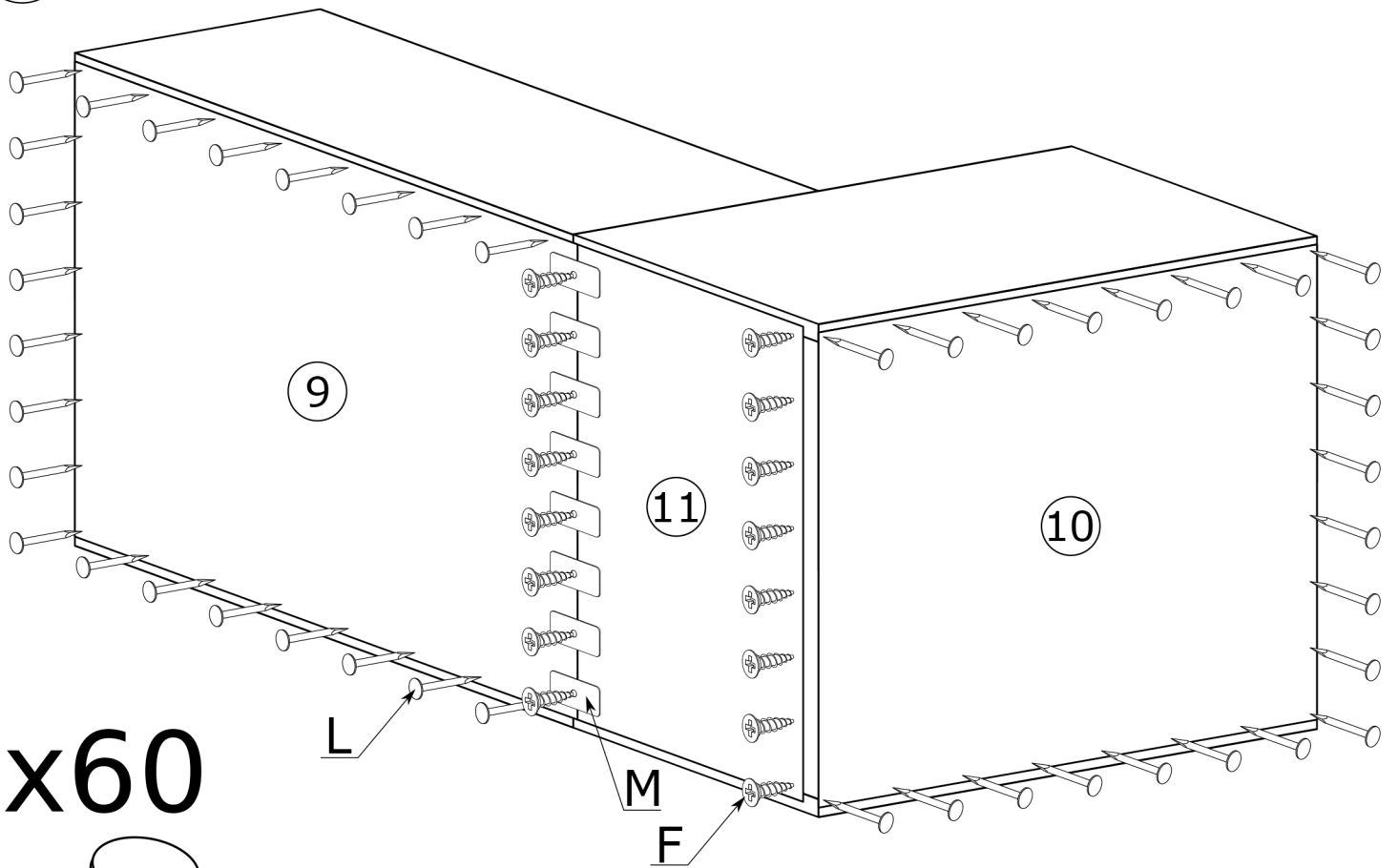

x60

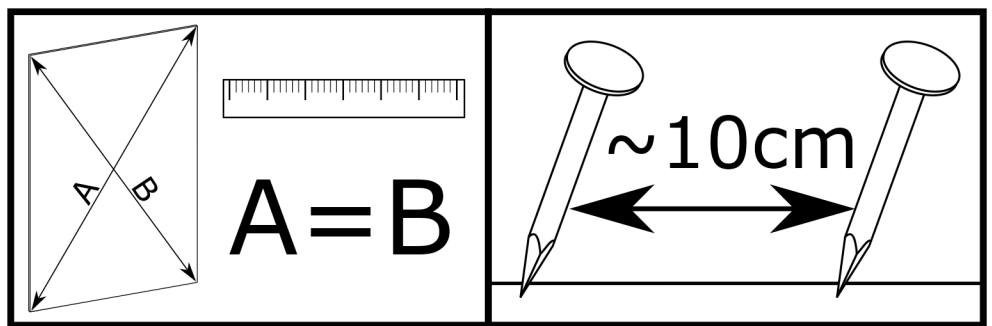
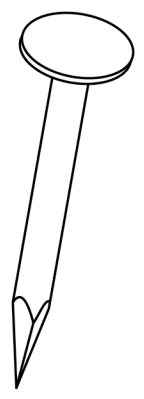

VII

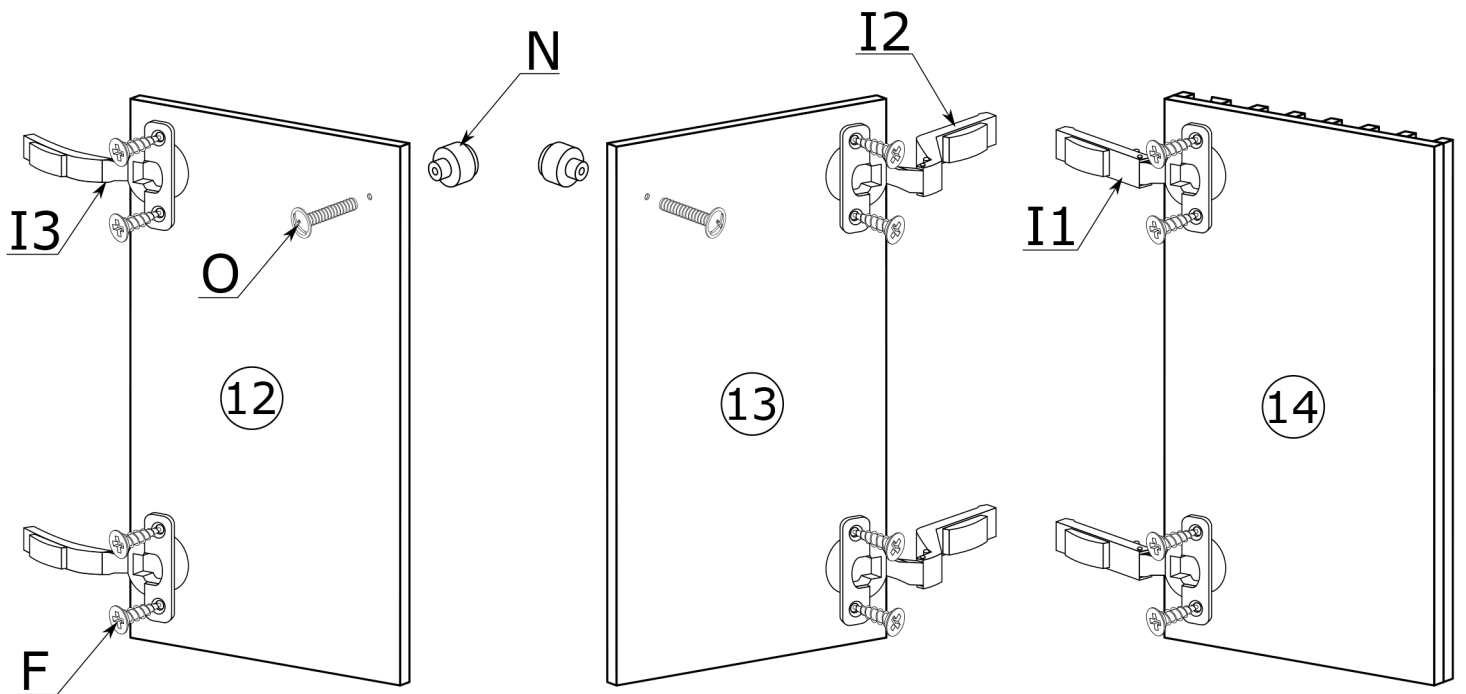

VIII

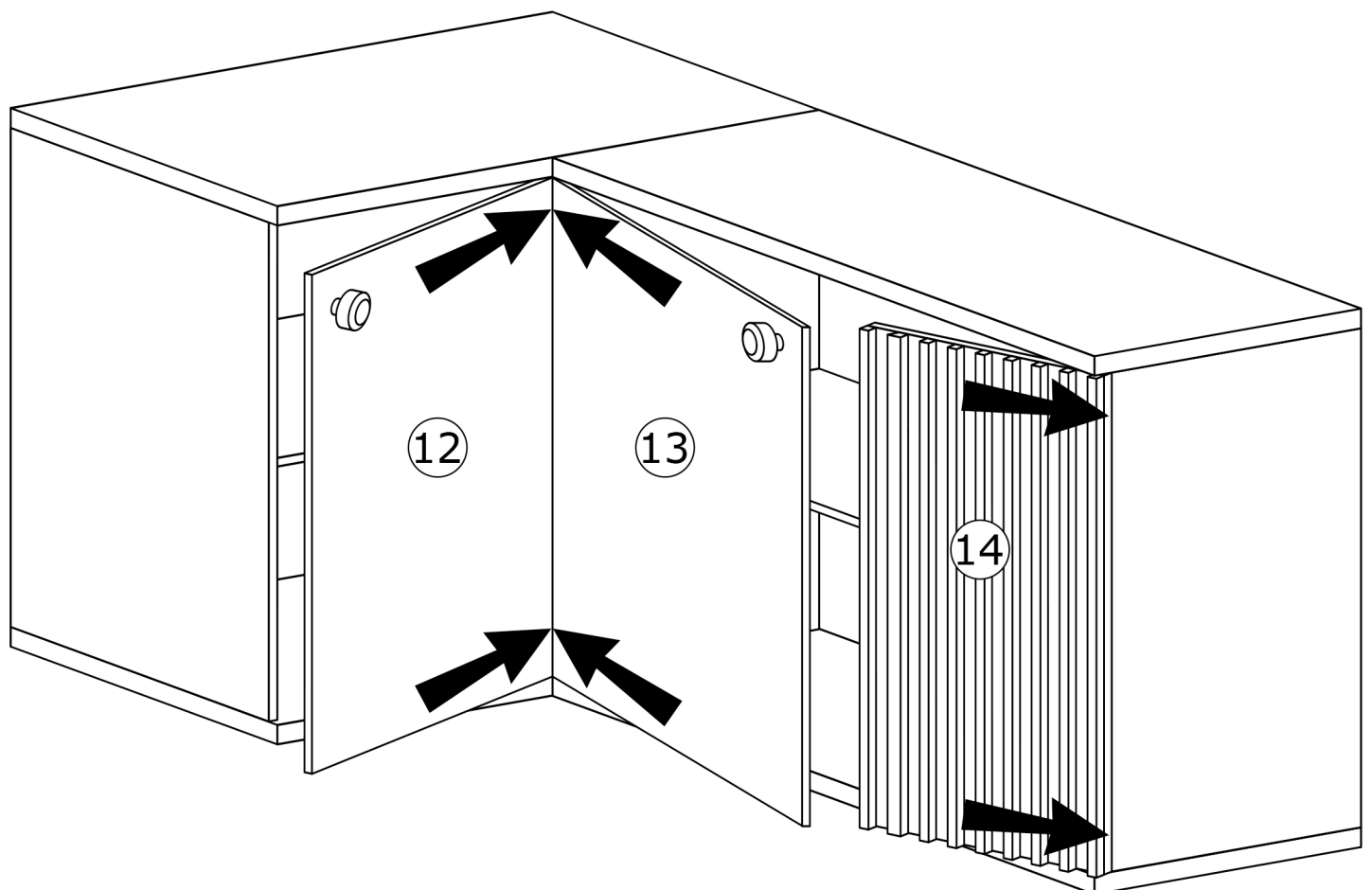

II

