

# KOLI C-21

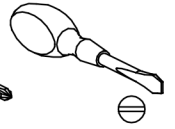

1	1000	550	16	1
2	600	520	4	1

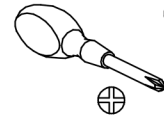
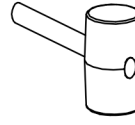
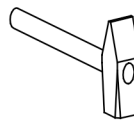
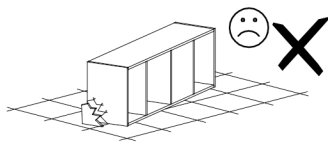
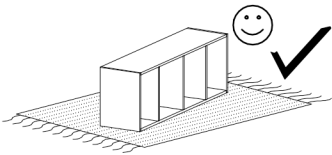
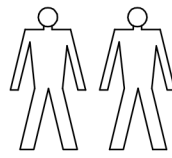
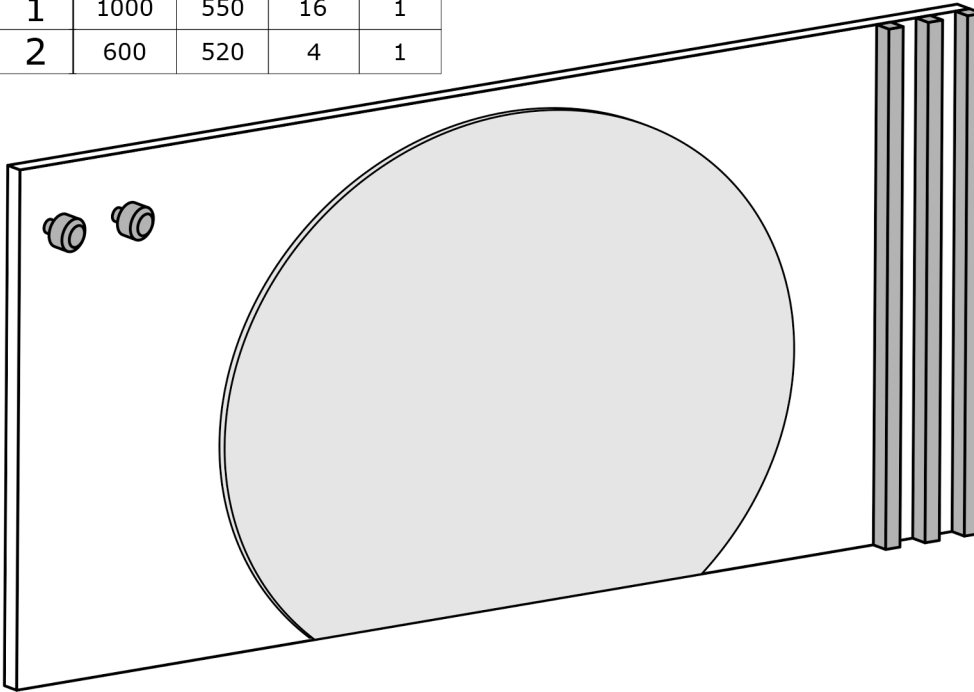

I

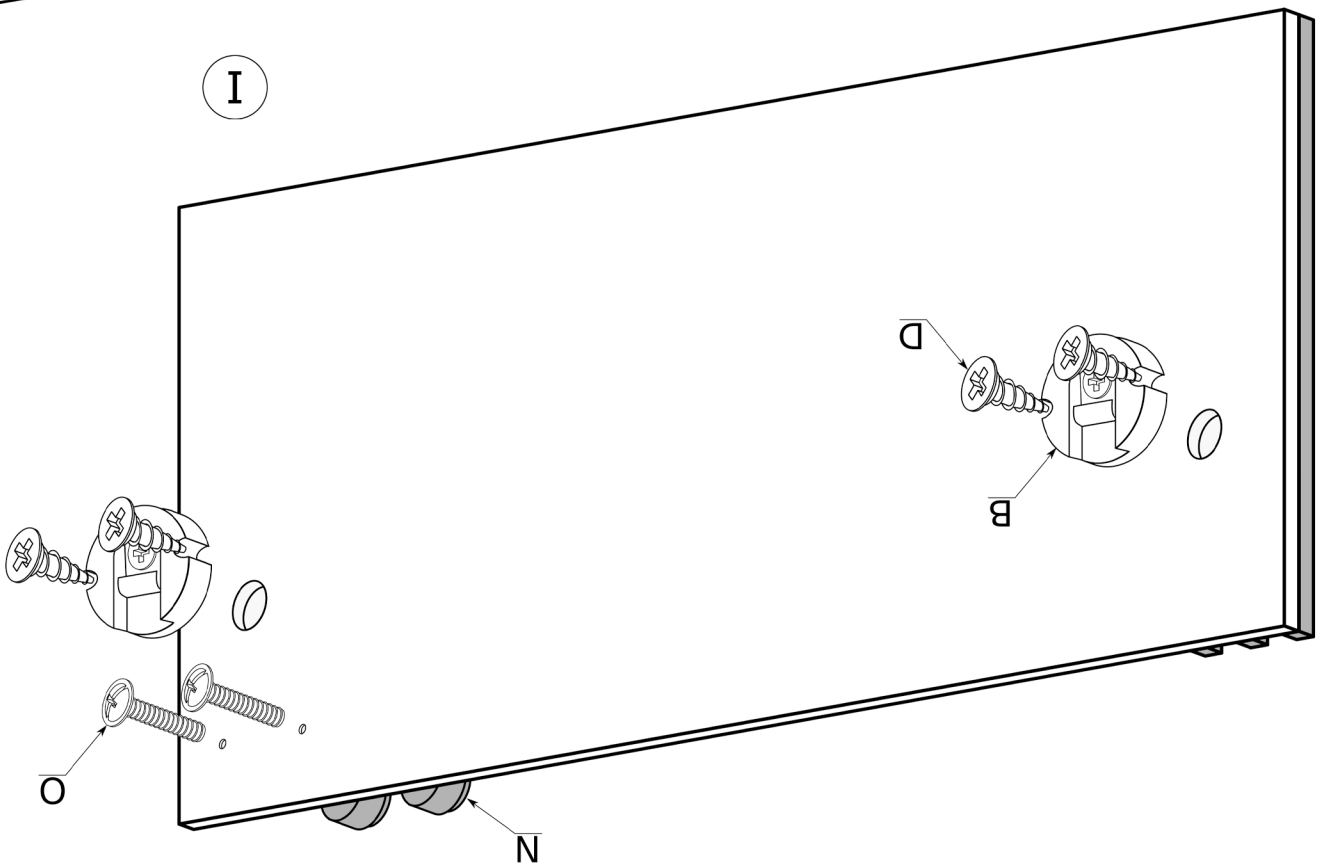

**B - 2 St.**

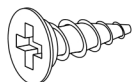

**D - 4 St.**  
3,5x13 mm

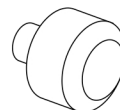

**N - 2 St.**

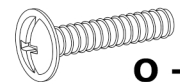

**O - 2 St.**  
3,5x20 mm