

NESEBAR XL

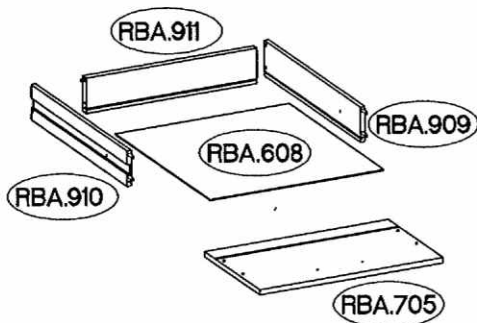
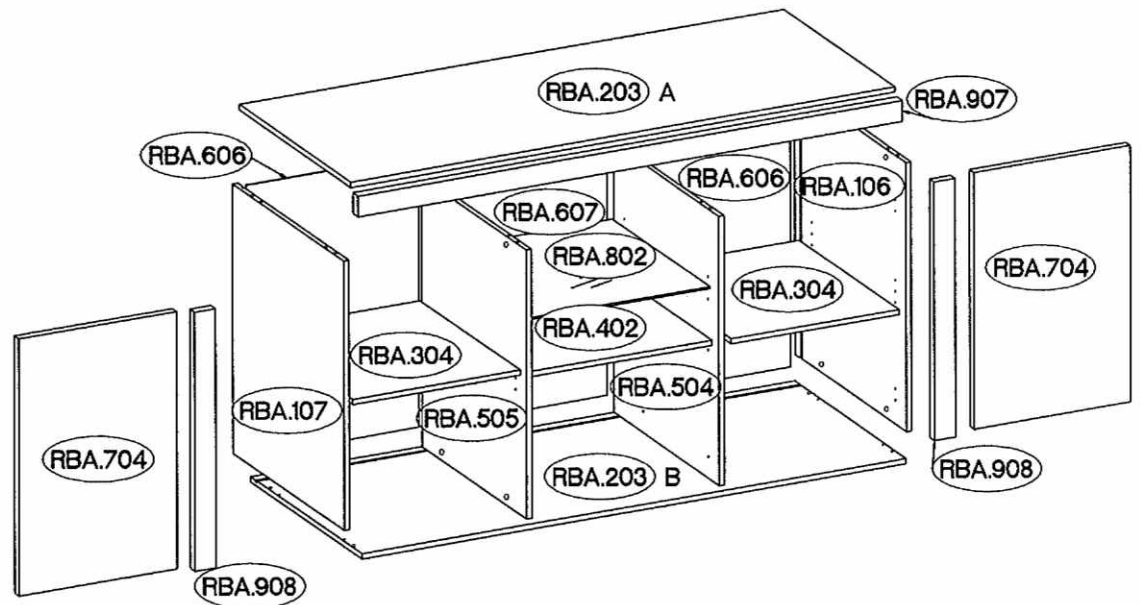
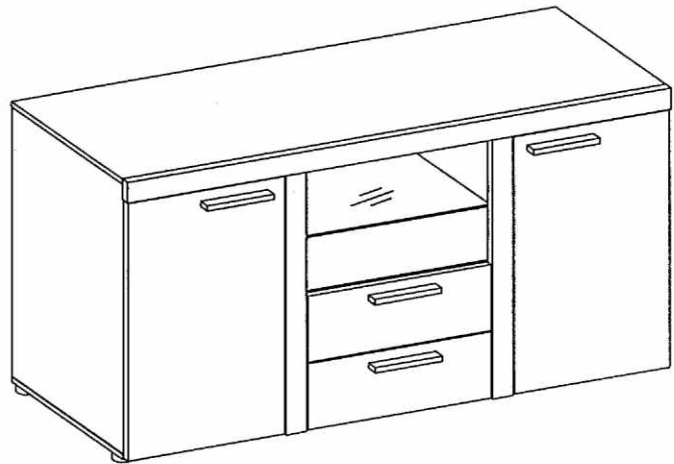

J14	O7	L9
8	2	2

M3	B2	T9	F10	P14
8	4	9	6	6

L2	P5	P1	R2	J12	U1	O1	I	T4
10	10	26	8	4	4	1	2	2

E	H	P7	D2	C	A	L	S1	J3	G
16	4	13	20	20	16	14	4	8	4

1

310/27mm I	 T4	±8x30mm A	±15/12mm C	L=20mm D2	±6,3x20mm M3	 F10	±4.0x25mm P14	±4.0x16mm P1
2	2	16	20	20	8	6	6	13
 T9	±20/8mm J14							
9	8							

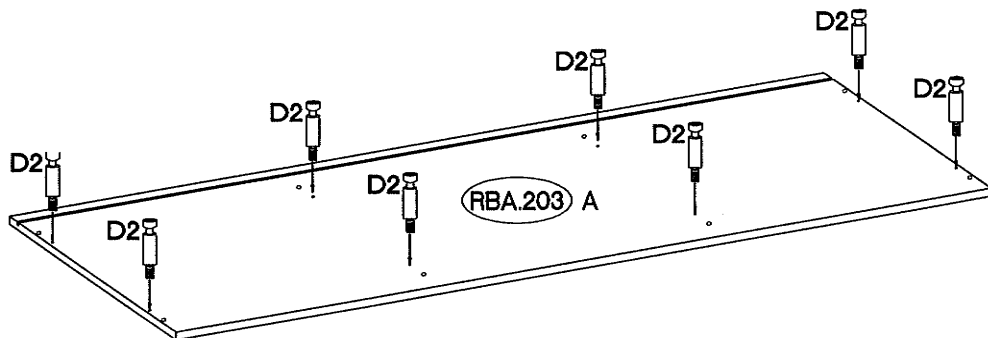
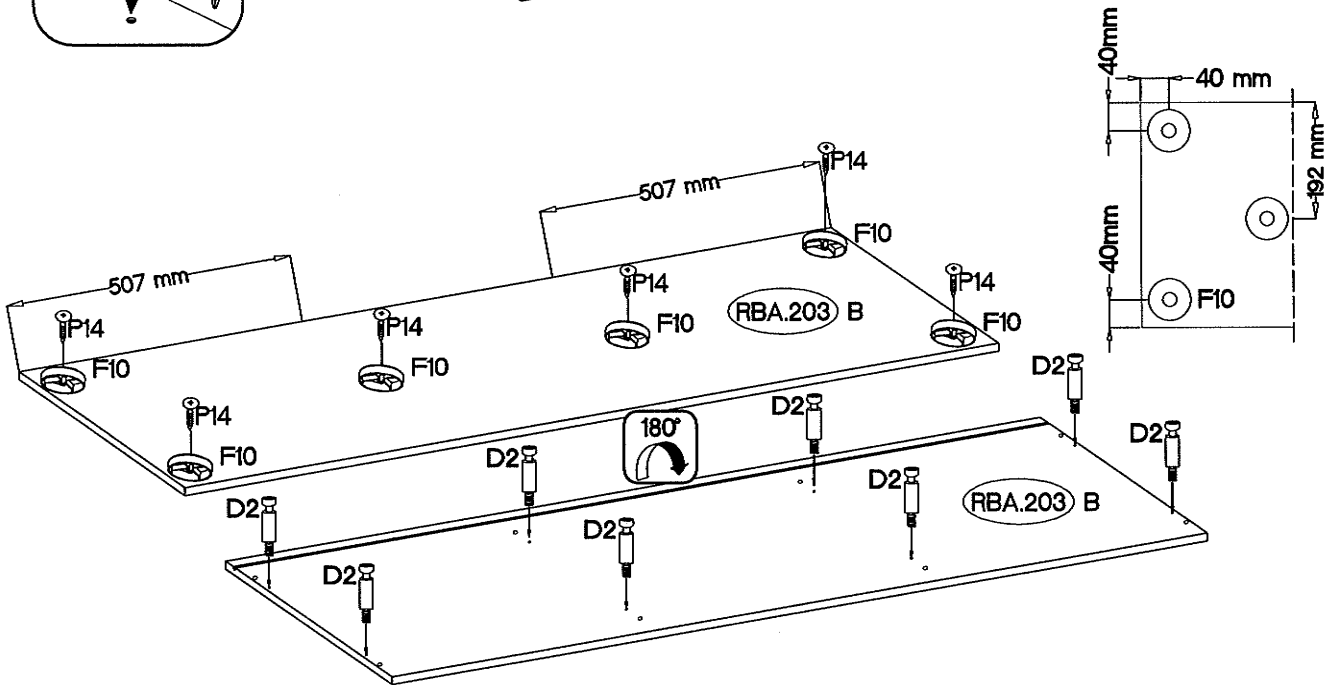
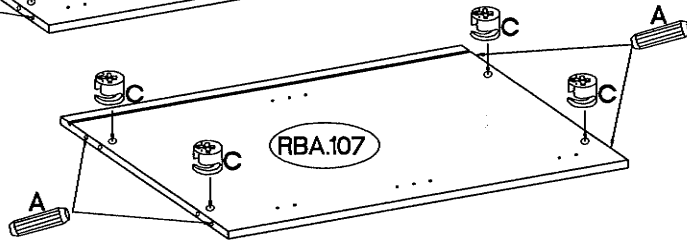
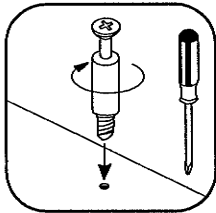
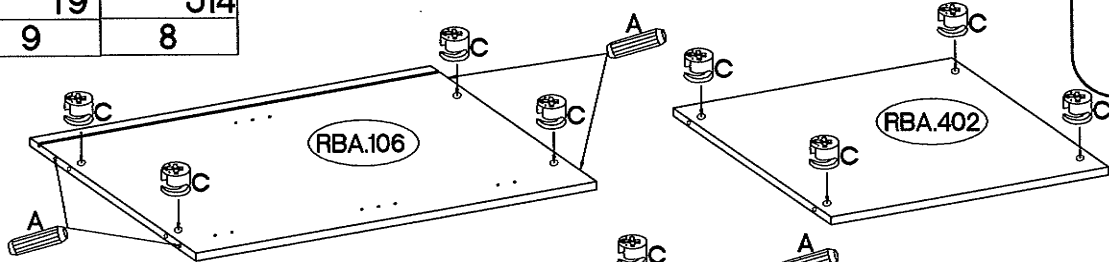

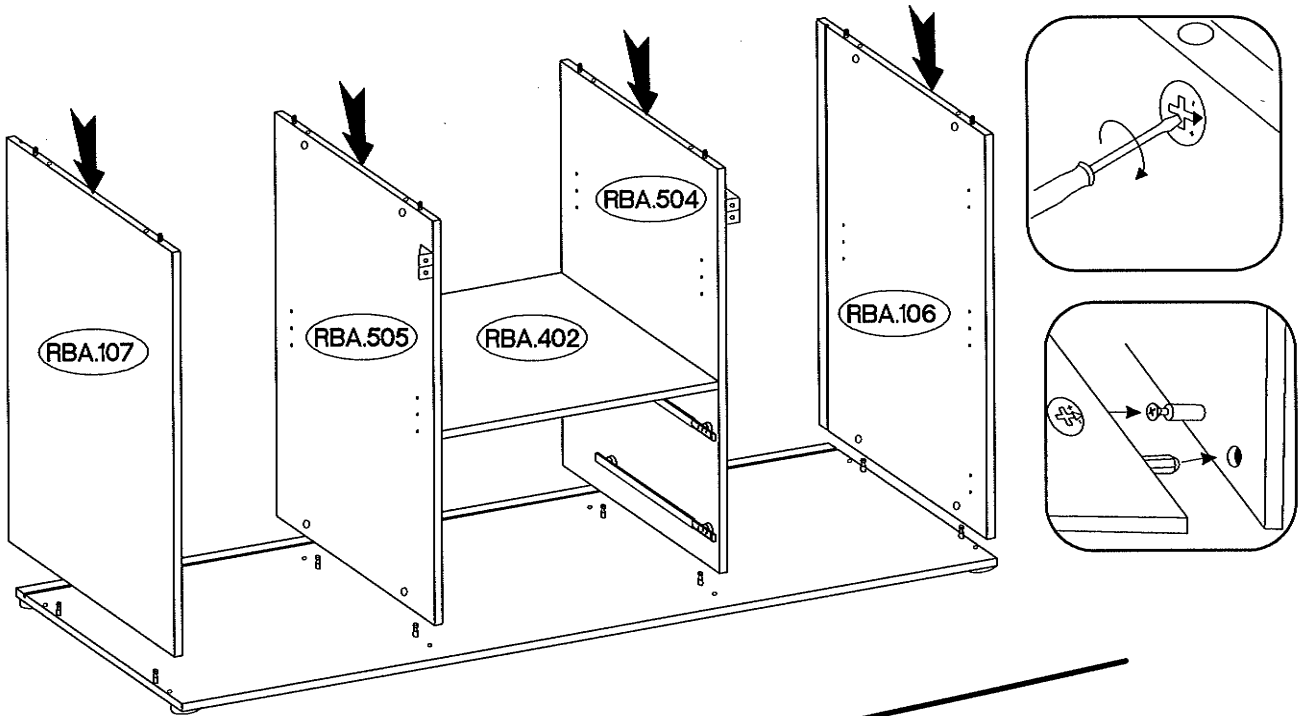

3

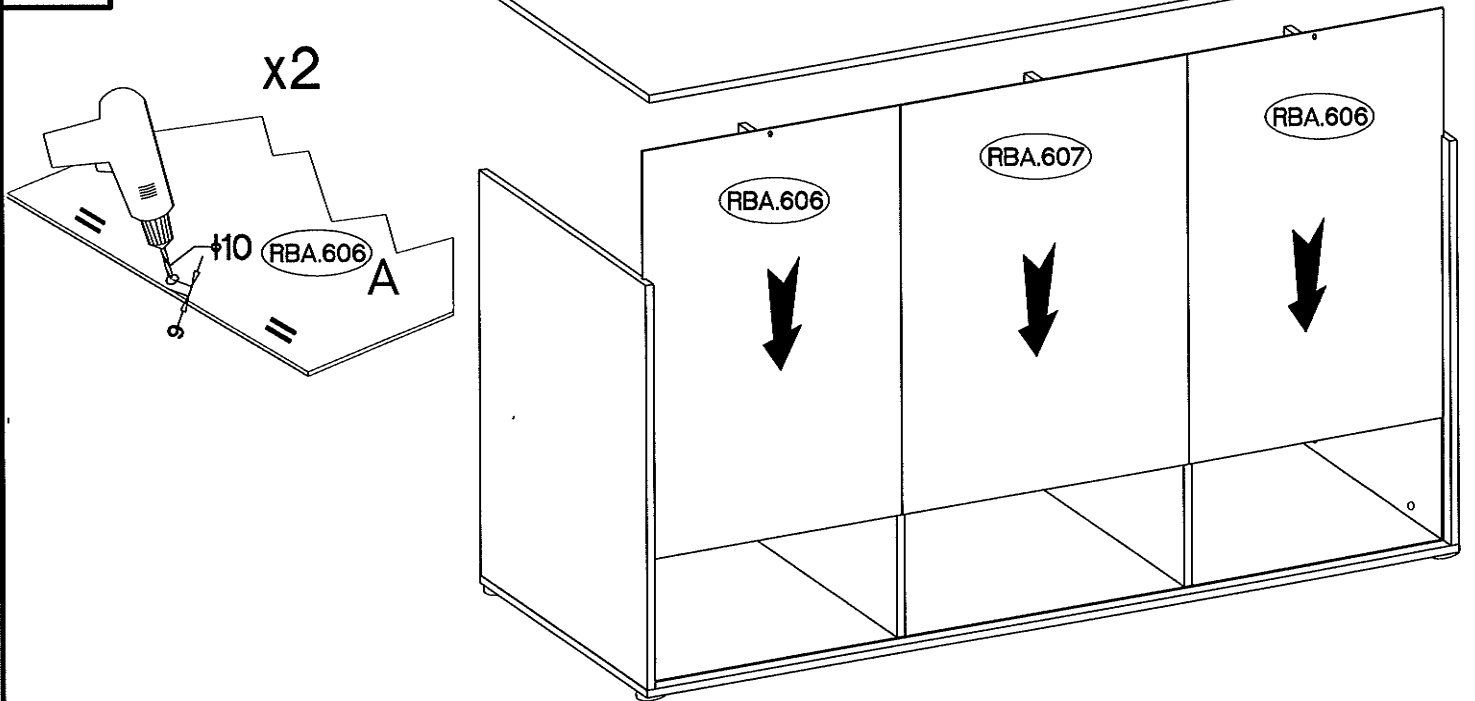

4



5

 P7 13	 L2 10	 L 10
---	---	--

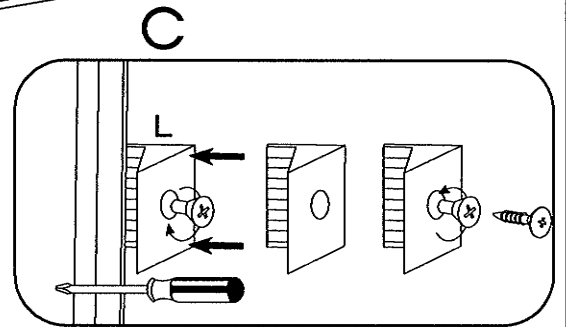
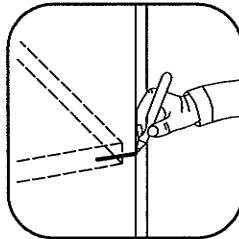
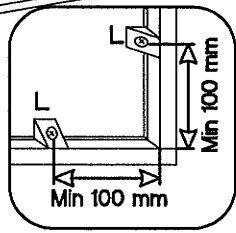
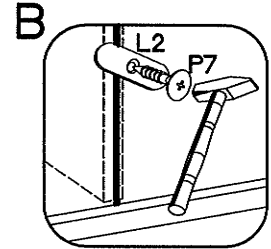
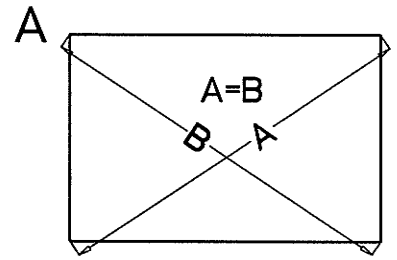
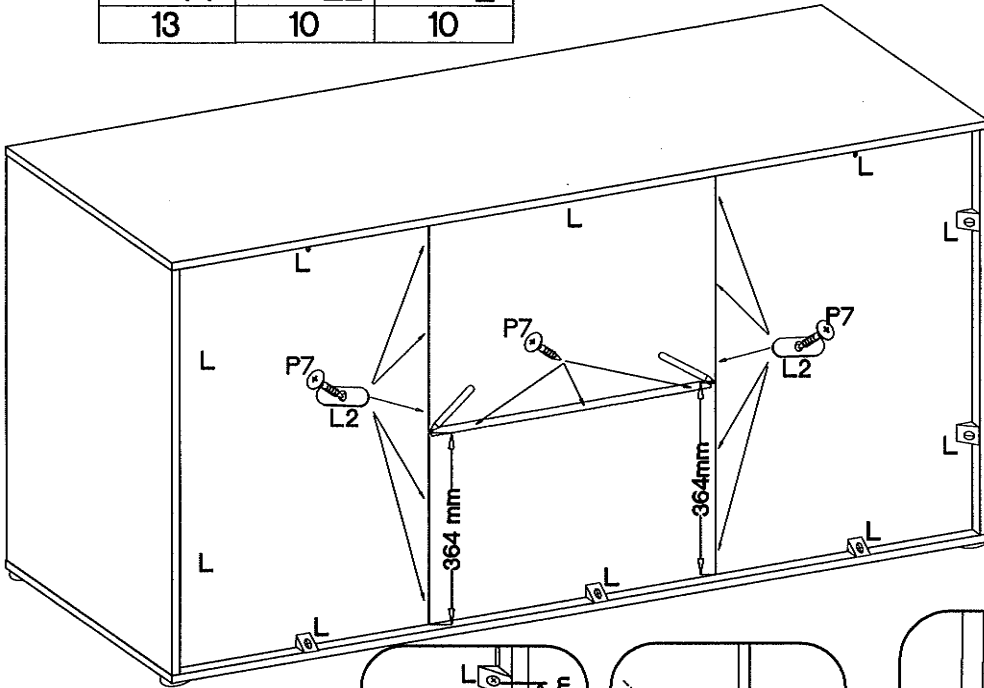

6

 P1 13

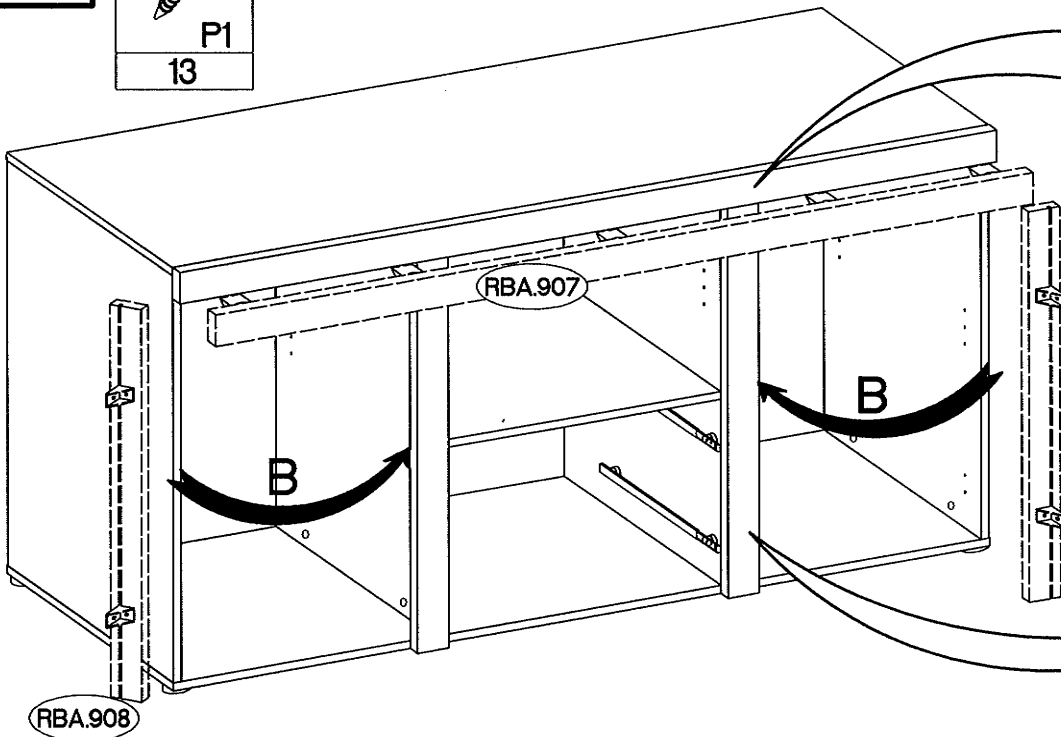

x2

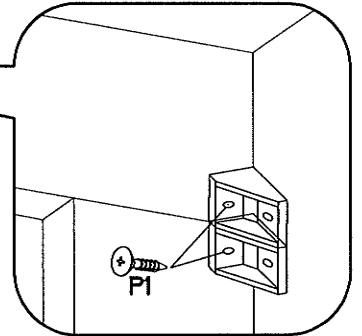

x9

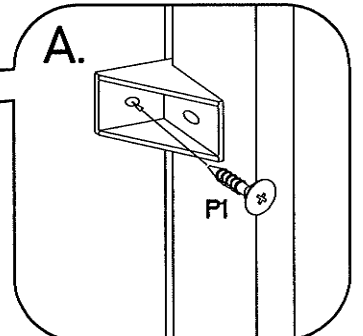

7

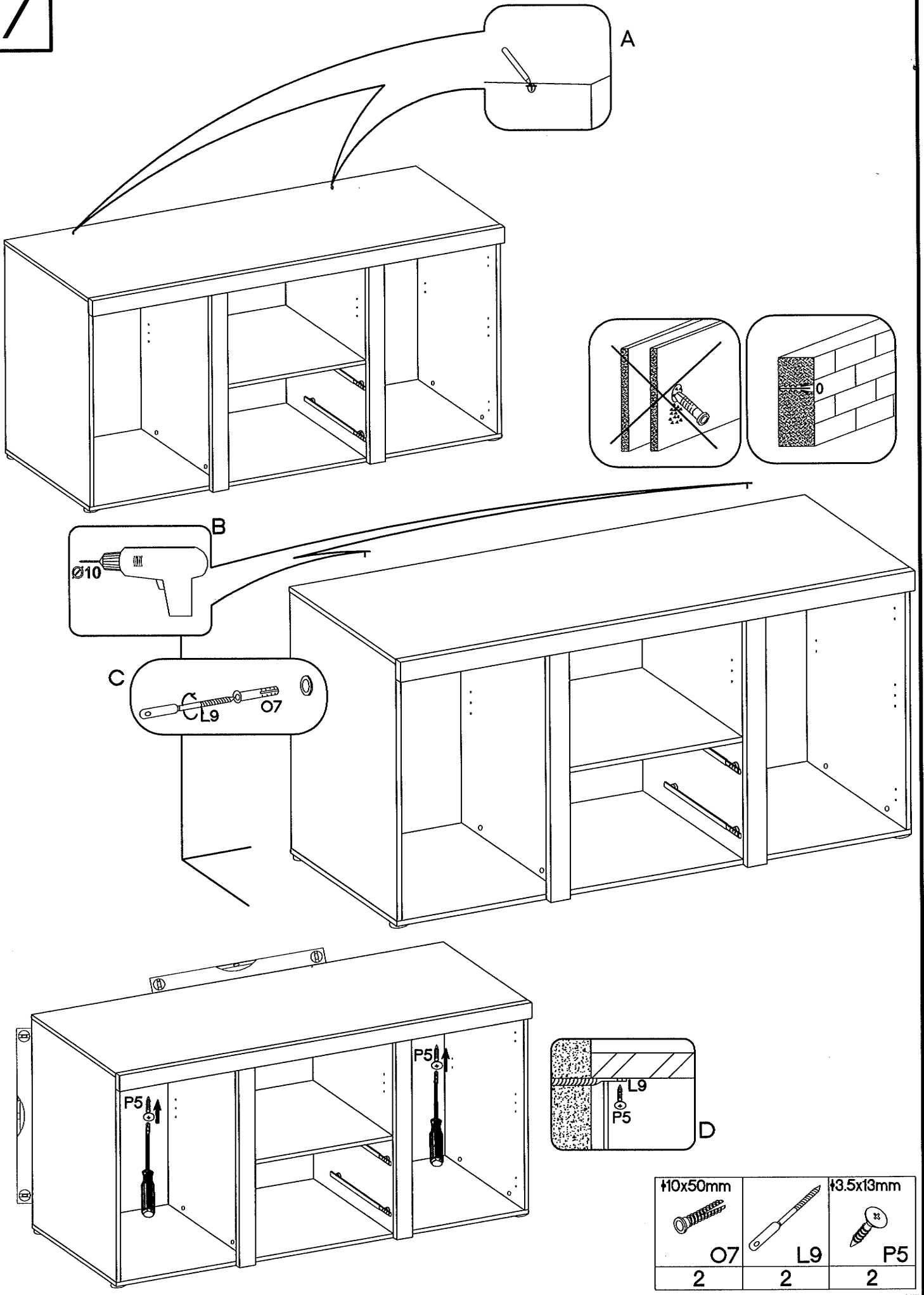

A

B

C

D

Ø10

L9

O7

P5

P5

†10x50mm

†3.5x13mm

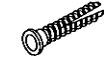

O7

L9





P5

2

2

2

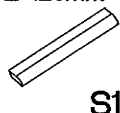

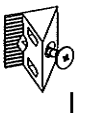
8

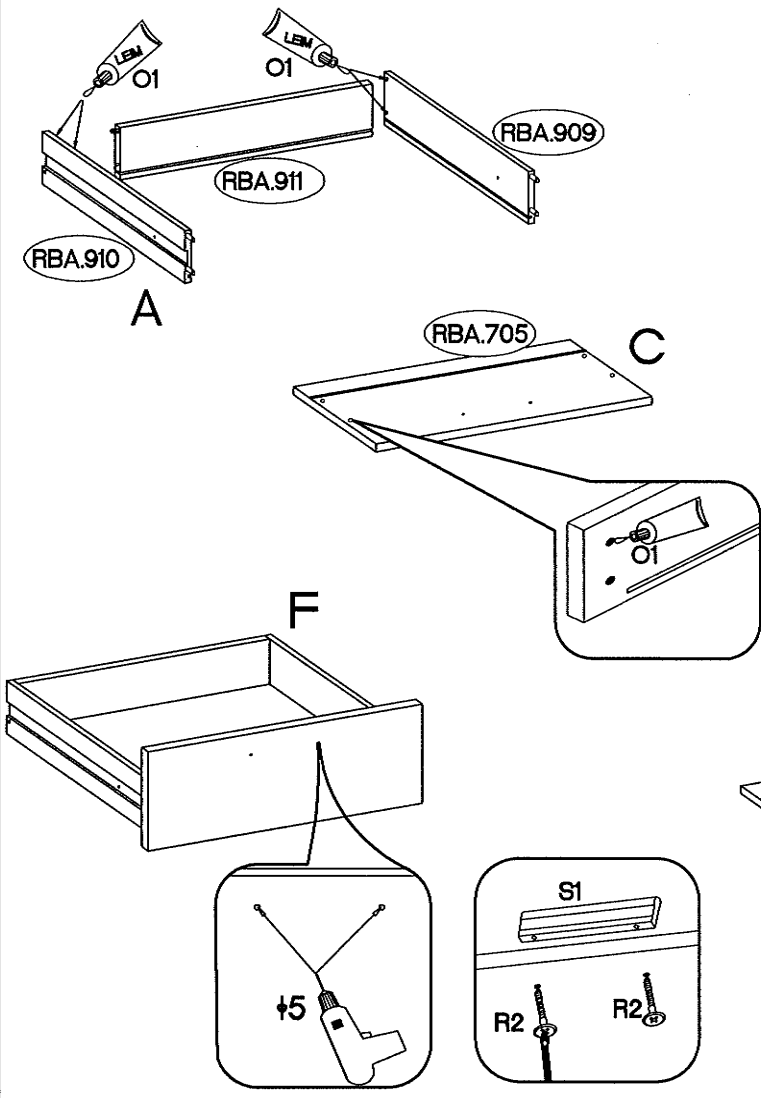
$\pm 6 \times 42 \text{mm}$  B2 4	 O1 1	$L=128 \text{mm}$  S1 2	$\pm 4.0 \times 30 \text{mm}$  R2 4	 L 4
--	---	--	--	--



x2

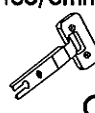



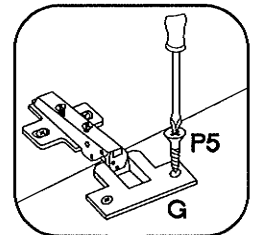
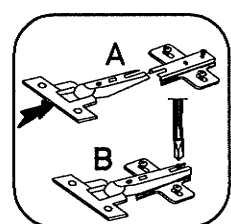

9

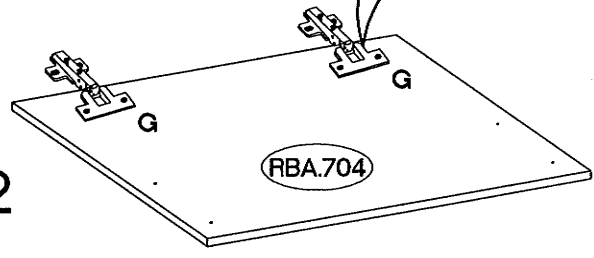
$H=0$  H 4	$\pm 35/0 \text{mm}$  G 4	$\pm 3.5 \times 13 \text{mm}$  P5 8
---	--	--



x2



±5/16mm  J3	 J12	L=128mm  S1	±4.0x30mm  R2	M4x9mm  U1	 E
8	4	2	4	4	16

