

DALAN

| | | |
|--|-----|------------|
| | 740 | 1/5 |
| | 740 | |
| | 400 | |
| | | mm |

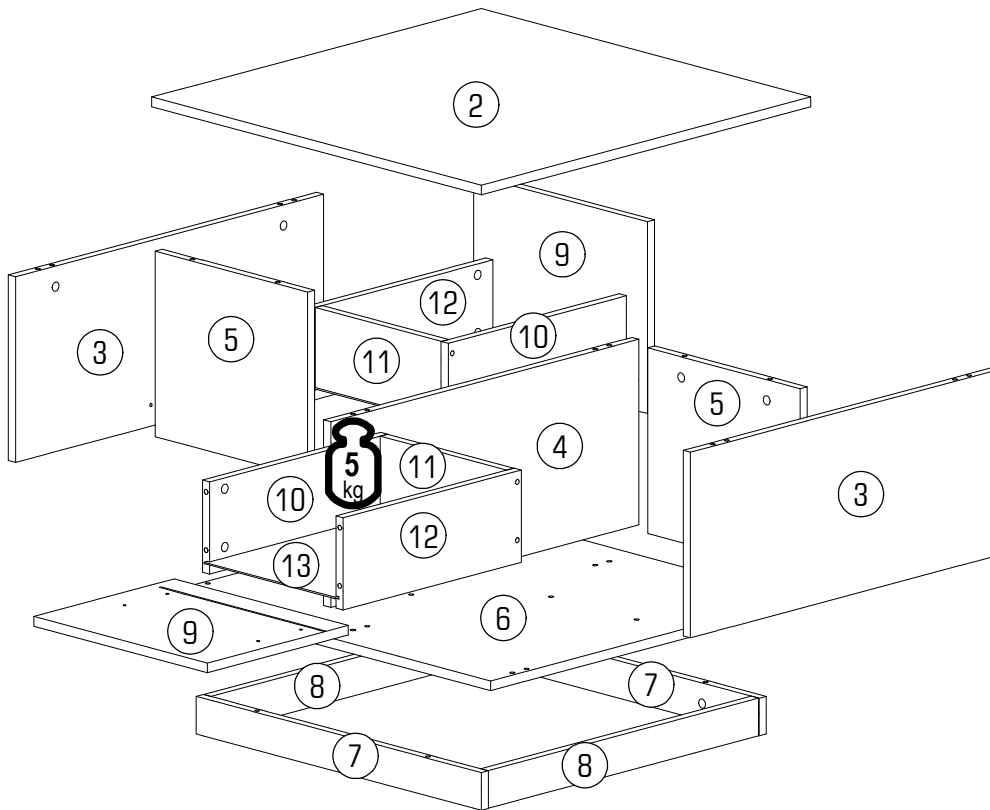

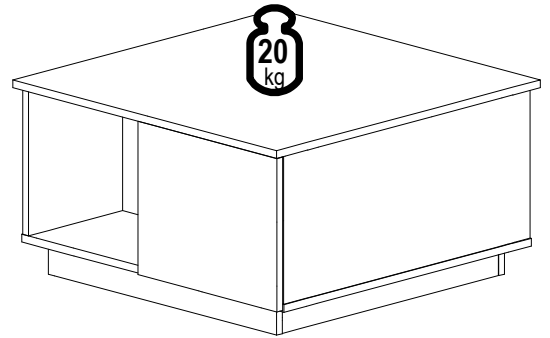

| ID | ID | | | |
|-------|----|-------------|----|-----|
| 15679 | ② | 740*740*16 | 1x | 1/1 |
| 15680 | ③ | 306*692*16 | 2x | 1/1 |
| 15681 | ④ | 306*692*16 | 1x | 1/1 |
| 15682 | ⑤ | 306*342*16 | 2x | 1/1 |
| 15683 | ⑥ | 736*694*16 | 1x | 1/1 |
| 15684 | ⑦ | 640*62*16 | 2x | 1/1 |
| 15685 | ⑧ | 608*62*16 | 2x | 1/1 |
| 15686 | ⑨ | 390*316*16 | 2x | 1/1 |
| 15687 | ⑩ | 400*152*16 | 2x | 1/1 |
| 15688 | ⑪ | 284*132*16 | 2x | 1/1 |
| 15689 | ⑫ | 400*152*16 | 2x | 1/1 |
| 15690 | ⑬ | 406*294*2,5 | 2x | 1/1 |

| | | | |
|--------------|----------|------------|-------|
| 50 min | | 3m | |
| ≤ 0,5 kg | PZ 2 | 600 mm | 4 |



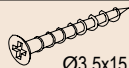

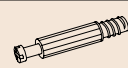

| | | | | | | | | | |
|-------------------------|-------------------------|-------------------------|-----------------------|-----------------------|--------------|------------------------|------------------------|--------------|-----|
| 22244.01 Ø3,5x16 | 33008.00 L=400mm | 22243.00 Ø3,5x15 | 22300.00 Ø7x50 | 27000.00 Ø8x30 | 30091.00 | 22705.00 Ø6,3x8 | 70013.01 Ø15x13 | 70021.01 | |
| A | B | C | D | E | F | G | H | J | K |
| 6x | 2x | 16x | 18x | 16x | 8x | 16x | 26x | 26x | 18x |

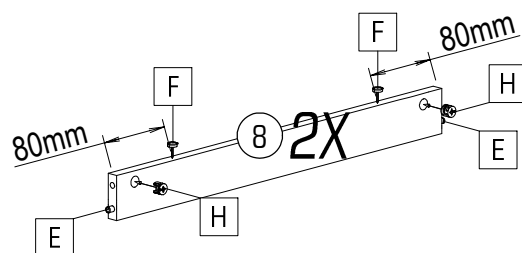
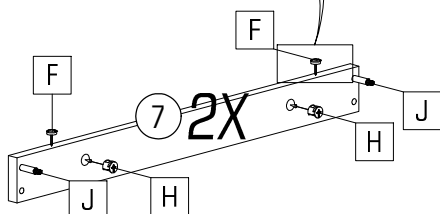
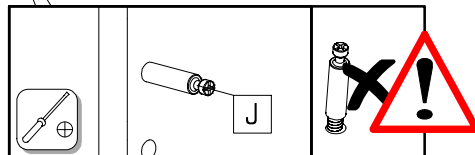
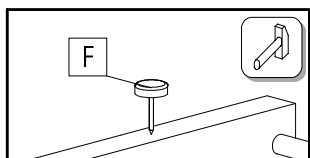
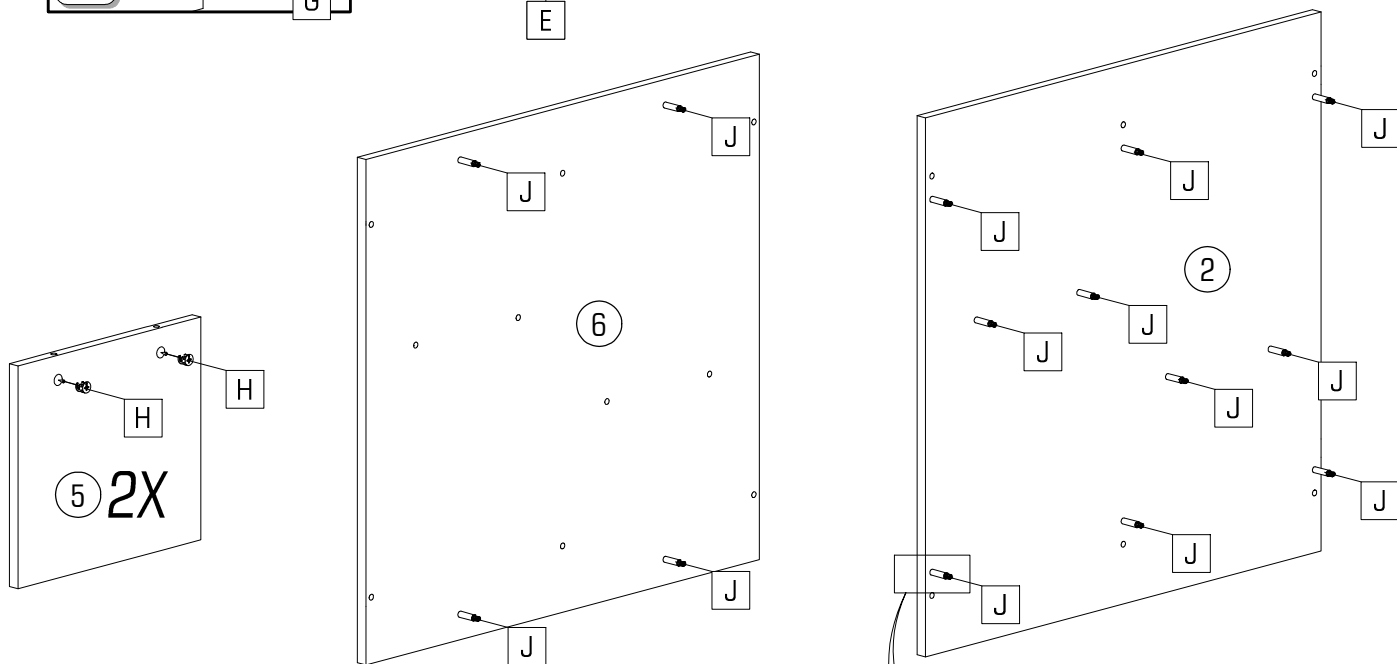
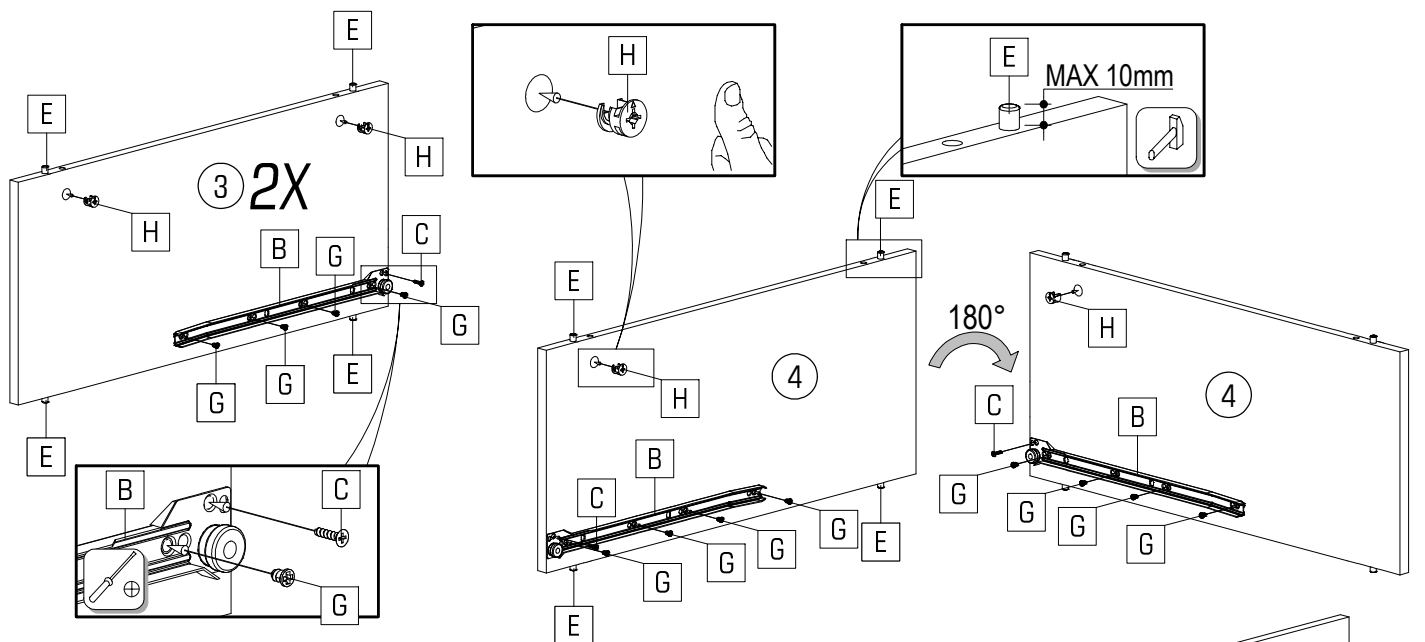

| | | | | | | |
|--|---|---|---|---|---|--|
|  |  |  |  |  |  |  |
| B 2x | C 4x | E 16x | F 8x | G 16x | H 14x | J 18x |

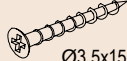

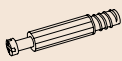
| | | | | | |
|--|---|---|---|---|---|
|  |  |  |  |  |  |
| A | B | C | D | H | J |
| 6x | 2x | 12x | 8x | 8x | 8x |

