

# KORNY

Art.-Nr.

327 170  
327 171

↔	1600
↕	1771
↗	520
	mm

1/10

vO

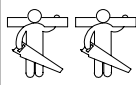

PZ2, PZ1

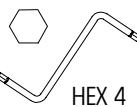

HEX 4



0,5 kg



3m

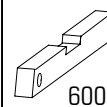

600 mm





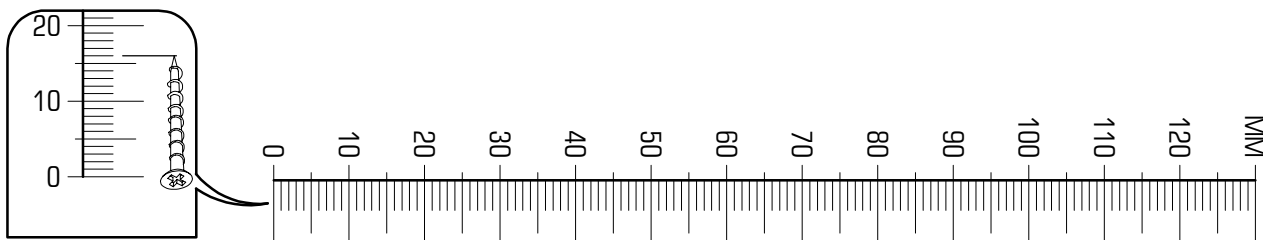
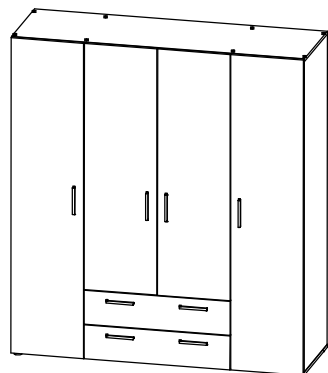
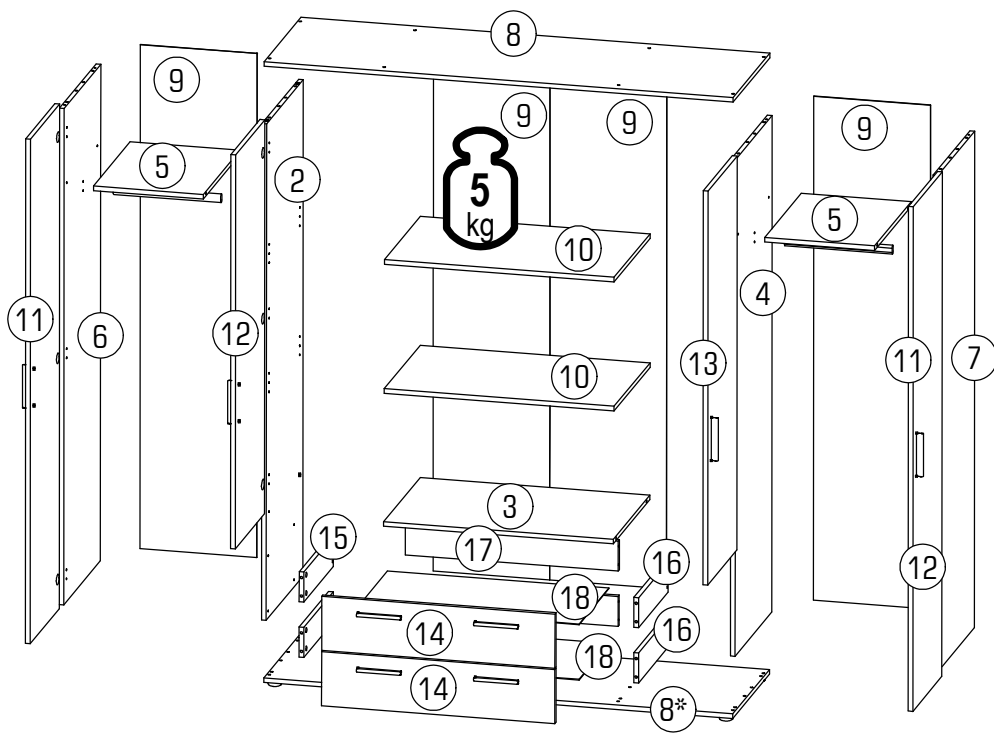
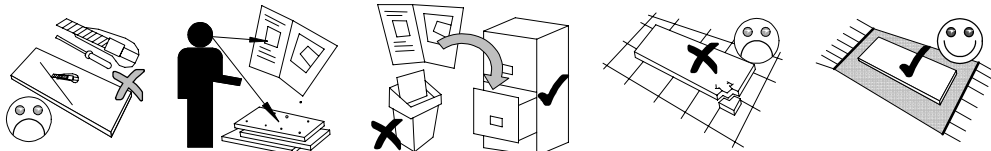

Ø8

ID	ID	Image	Image	Image
18910	②	499*1724*16	1x	1/3
18912	③	784*498*16	1x	3/3
18911	④	499*1724*16	1x	1/3
18913	⑤	375*498*16	2x	3/3
18908	⑥	1724*499*16	1x	1/3
18909	⑦	1724*499*16	1x	1/3
18915	⑧	1600*500*16	2x	3/3
18914	⑨	1750*398*3	4x	2/3
18916	⑩	784*490*16	2x	3/3
18922	⑪	1752*396*16	2x	2/3
18923	⑫	1368*396*16	1x	2/3
18924	⑬	1368*396*16	1x	2/3
18917	⑭	796*188*16	2x	2/3
18918	⑮	400*104*16	2x	2/3
18919	⑯	400*104*16	2x	2/3
18920	⑰	104*726*16	2x	2/3
15735	⑱	406*756*3	2x	3/3

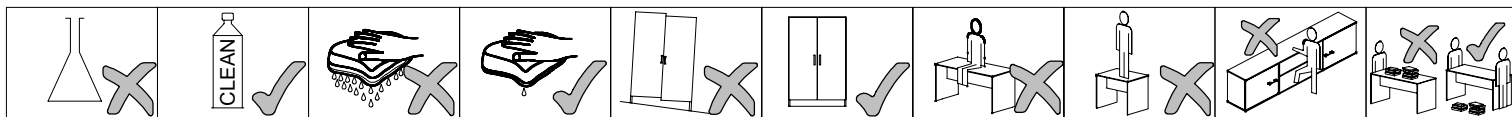

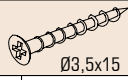
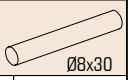
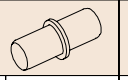

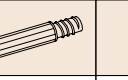
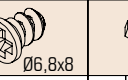
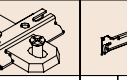

	21102,00		Ø1,6x20	75x	22213,00		Ø4,0x70	1x	22236,00		Ø2,5x16	34x	22243,00		Ø3,5x15	48x	22244,01		Ø3,5x16	14x	22300,00		Ø7x50	24x	22430,00		Ø4x25	16x	24008,00		3,0	34x	24103,00		Ø8	1x
	27000,00		Ø6x30	32x	30080,00		Ø44x15	6x	22250,00		Ø4x25	6x	31103,00		1x	35101,01		8x	70013,01		Ø15x13	20x	70018,01		4x	70021,01		20x	22705,00		Ø6,8x8	8x				
	32030,00		L=150	20x	36002,07		8x	8x	36002,07		6x	36002,07		6x	36013,02		6x	36013,02		6x	70017,60		L=367	2x	33008,00		L=400	2x	33008,00		L=400	2x				

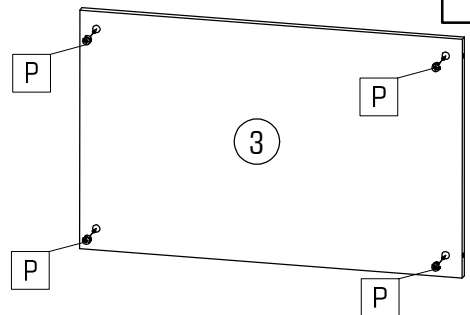
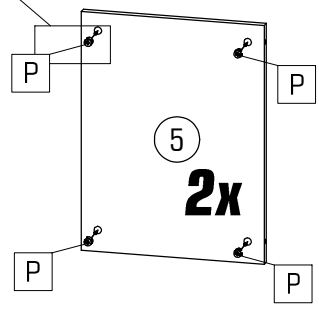
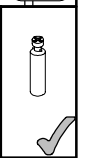
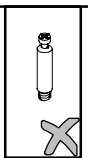
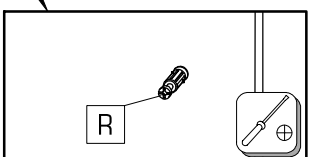
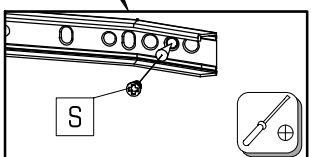
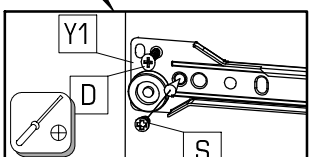
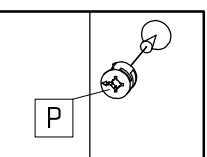
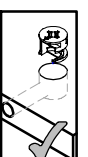
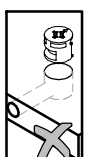
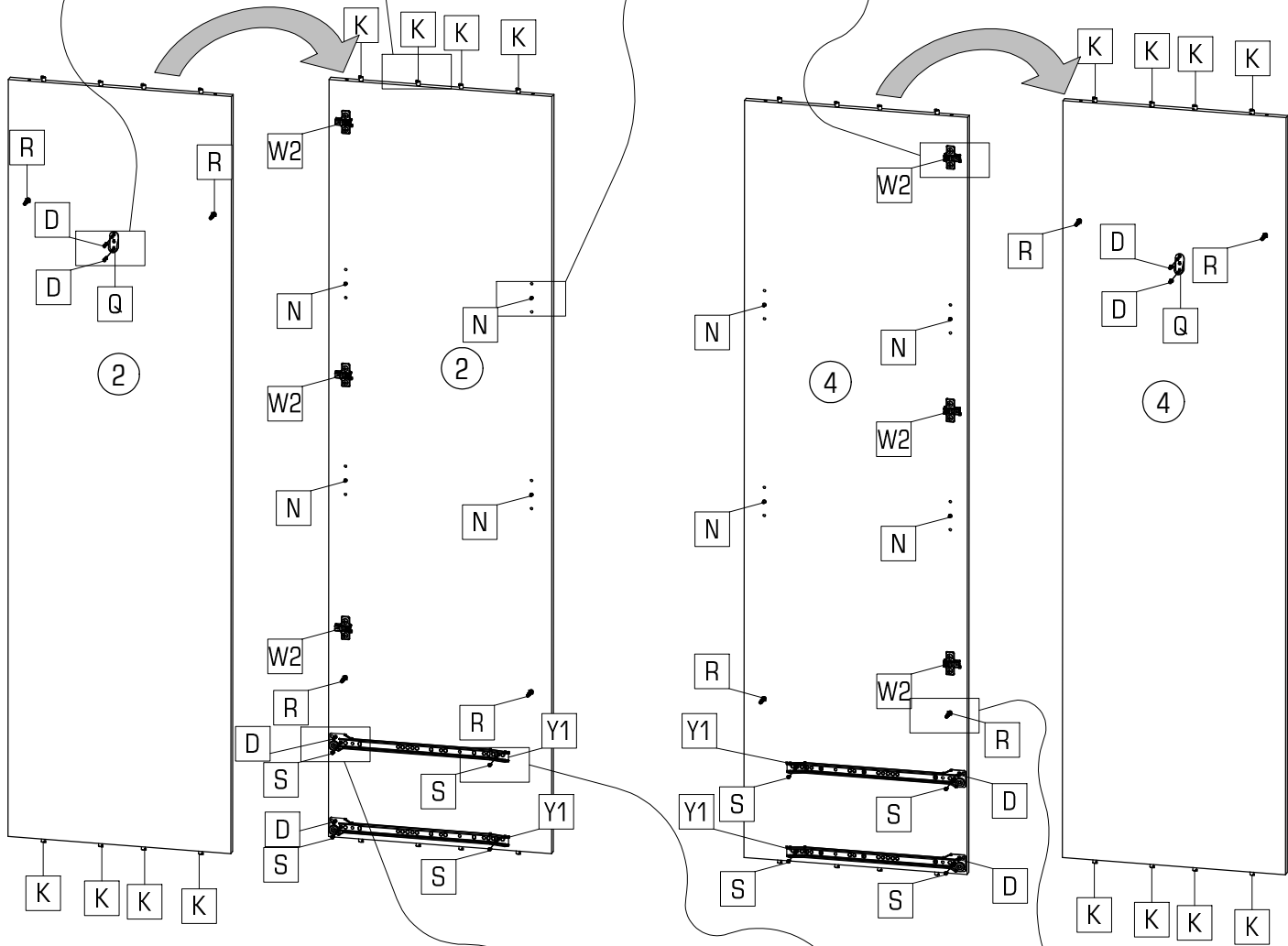
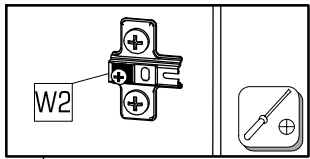
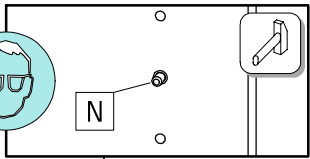
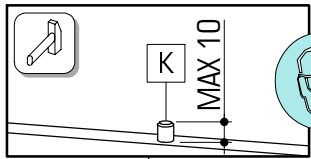
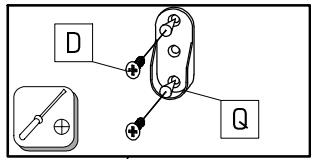

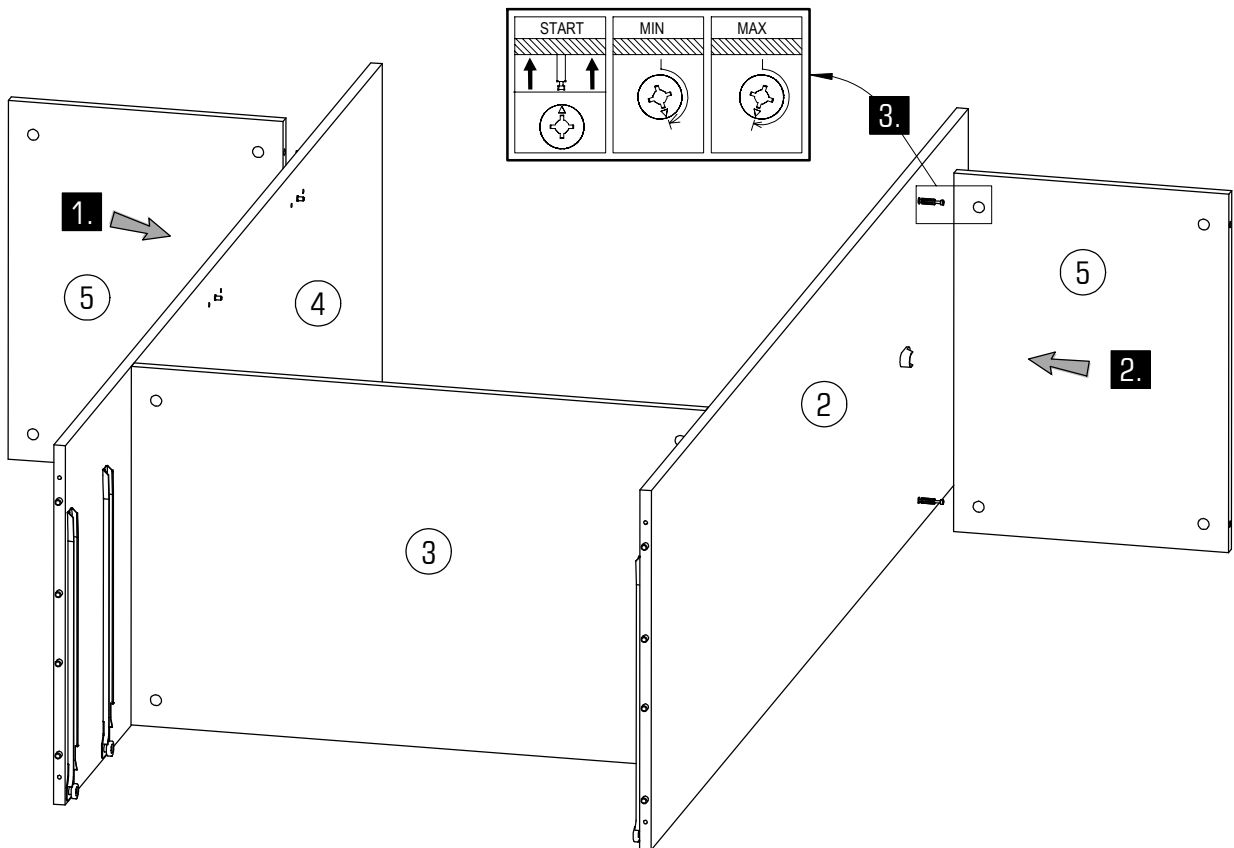
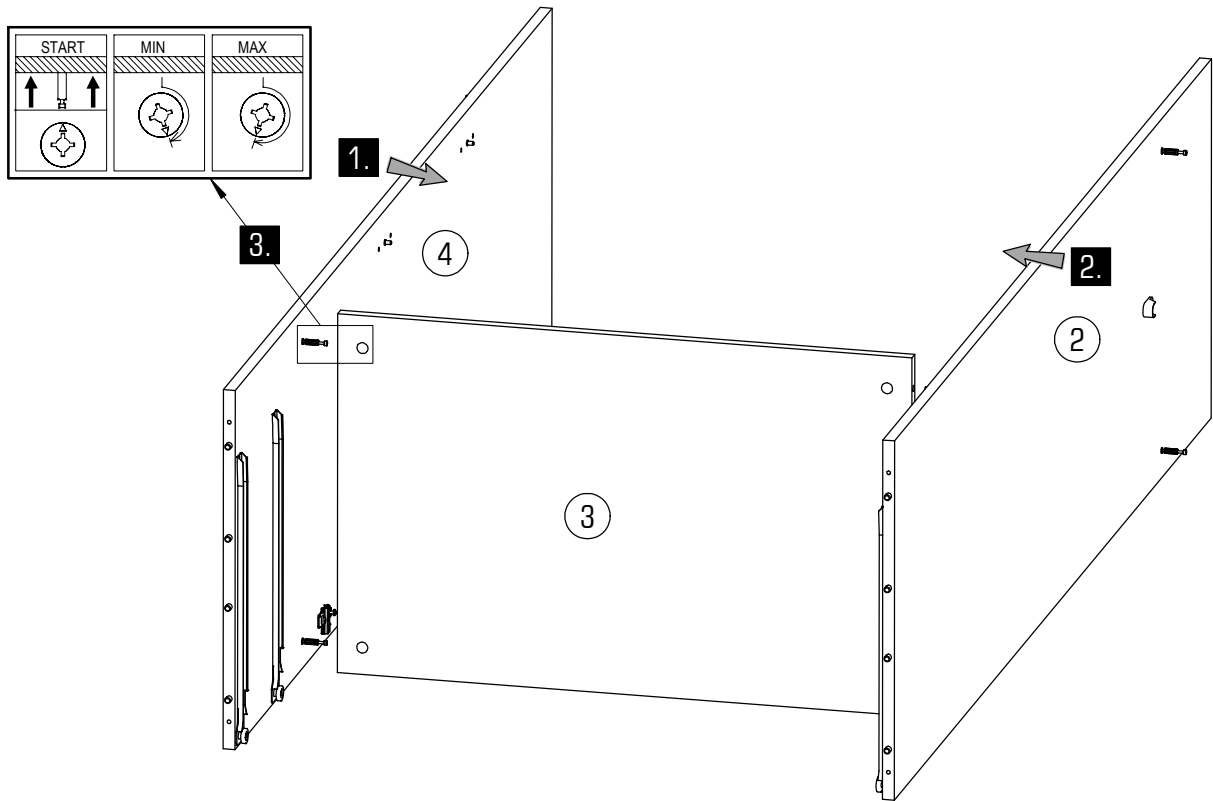

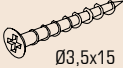
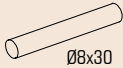
								
D 8x	K 16x	N 8x	P 12x	Q 2x	R 8x	S 8x	W2 6x	Y1 2x

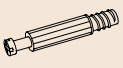



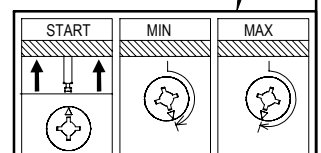
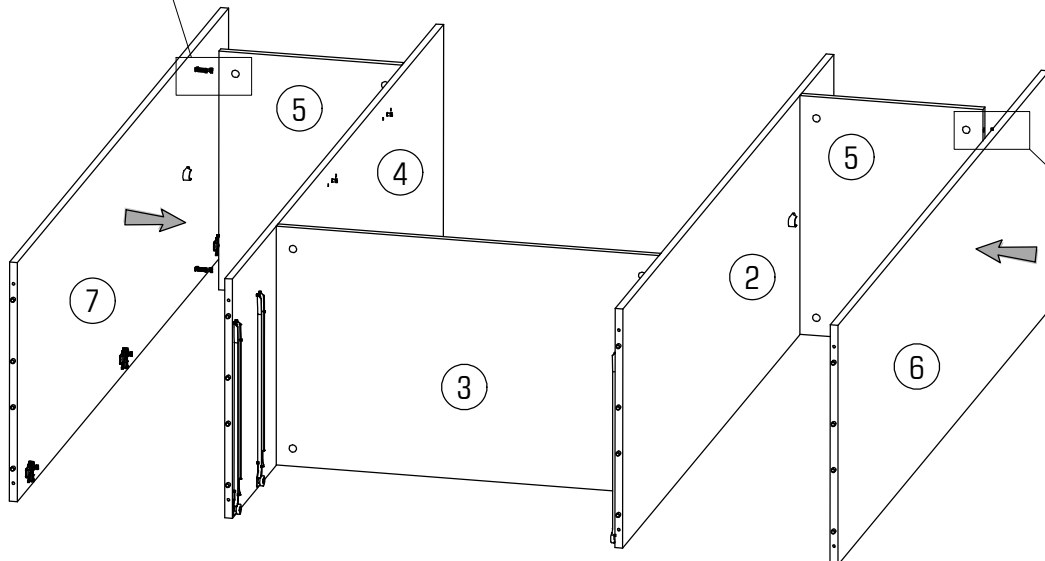
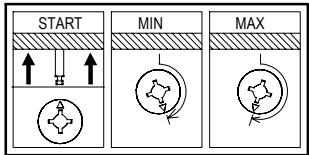
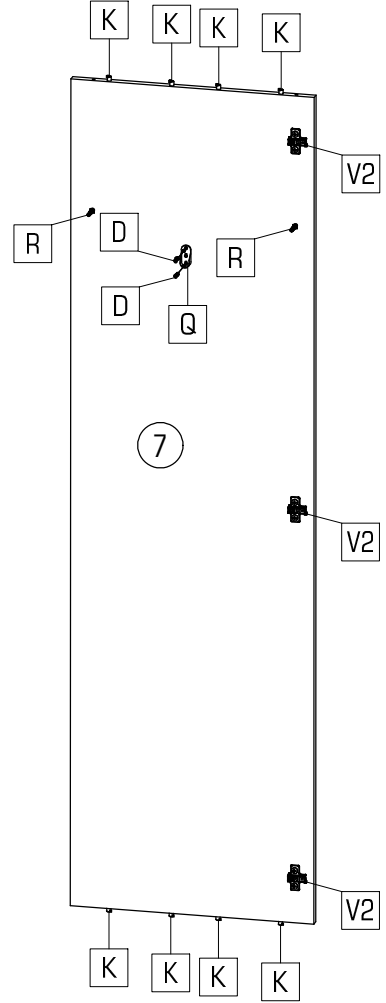
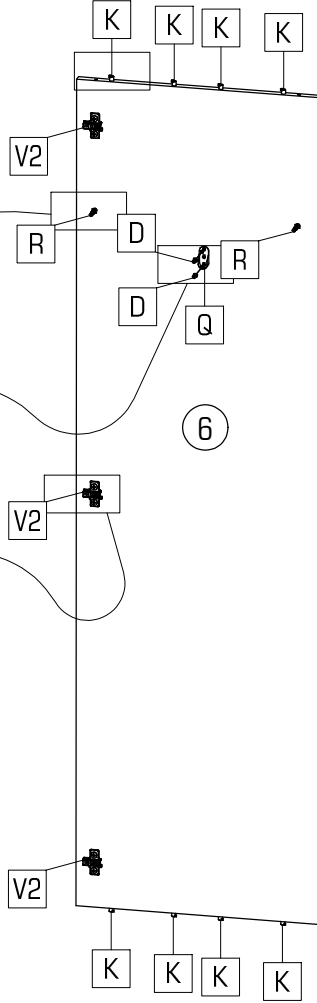
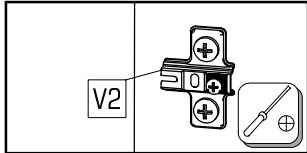
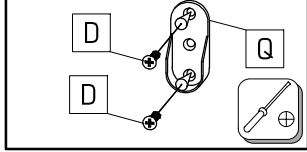
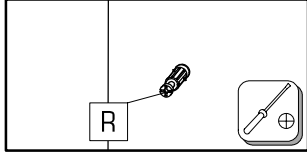
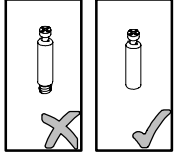
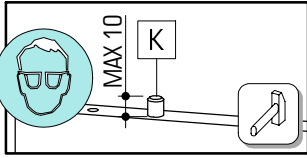



				
D	K	Q	R	V2
4x	16x	2x	4x	6x

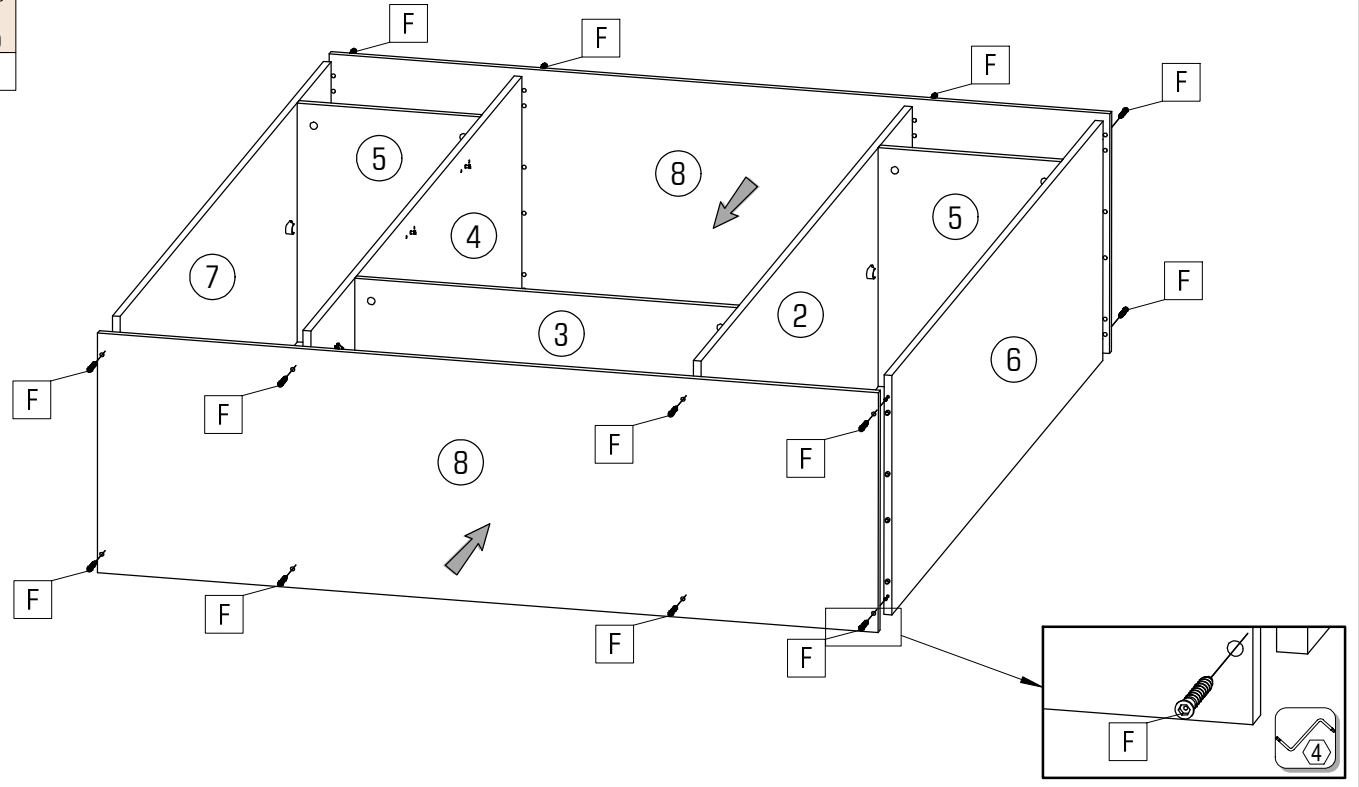

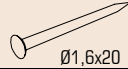
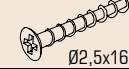



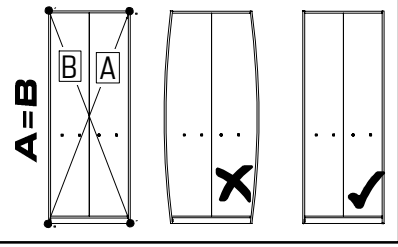
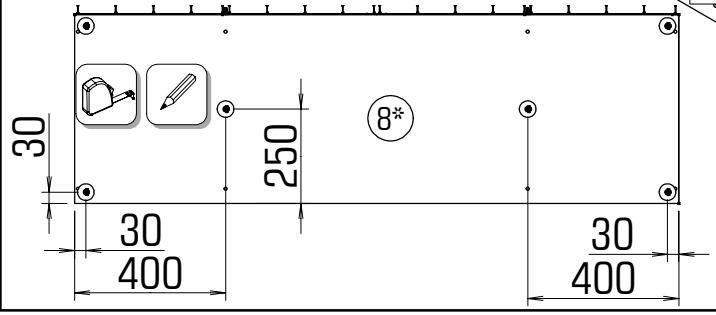
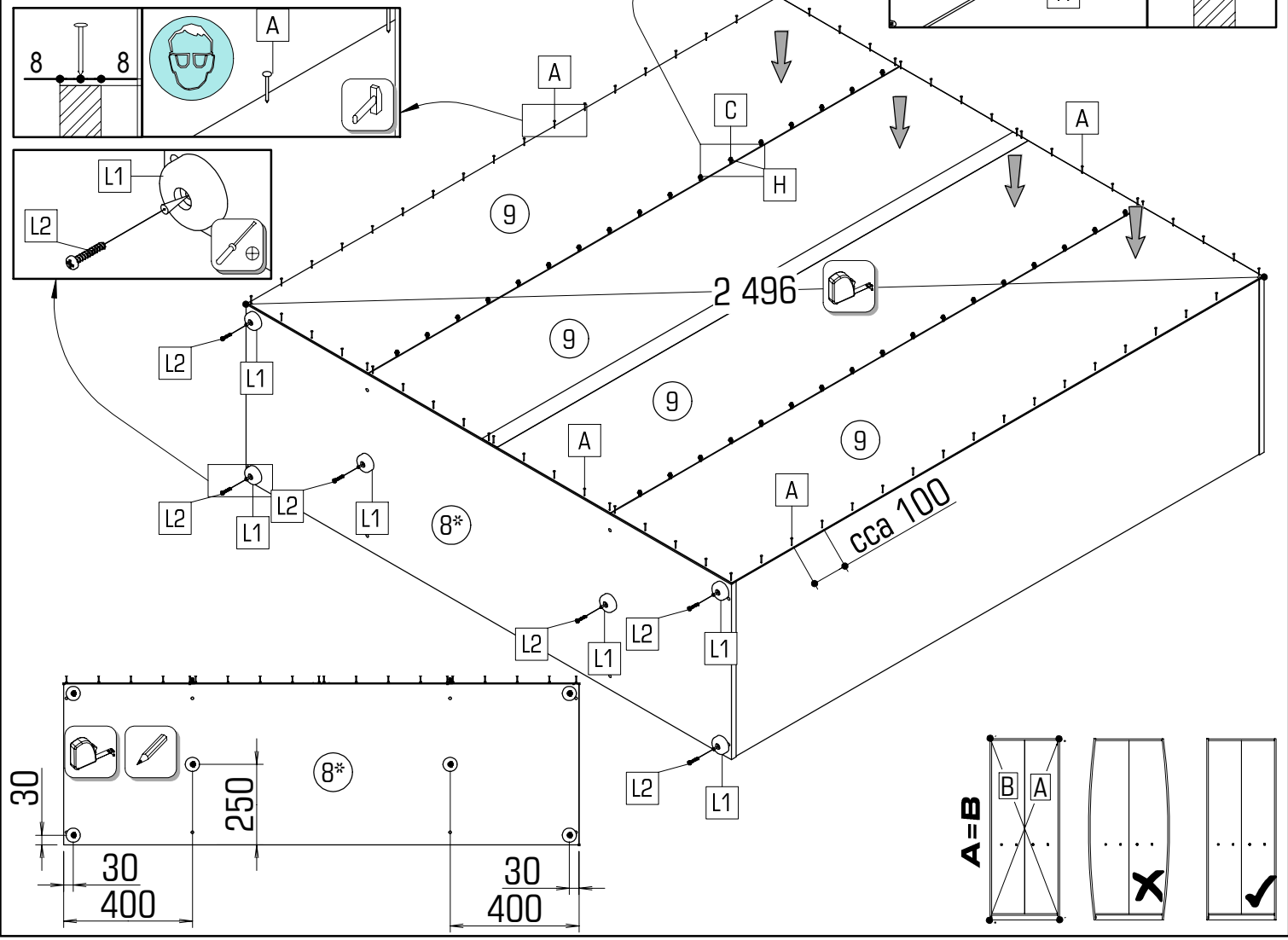

	Ø7x50
F	16x



	Ø1,6x20		Ø2,5x16		3,0		Ø4x15		Ø4x25
A	75x	C	34x	H	34x	L1	6x	L2	6x



					
B	E	J	M	T1	T2
1x	2x	1x	1x	12x	8x

X
2x

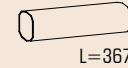

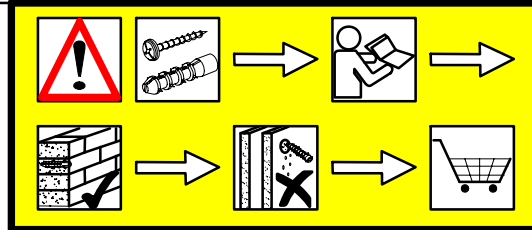
Upozornenie! Pevnosť steny sa musí pred montážou bezpodmienečne skontrolovať. Univerzálne hmoždenky, ktoré sú obsiahnuté v balení, používajte jedine pre pevné murivo ako je betón/tehla. Hmoždenky sa nesmú používať v prípade ľahkého staveného muriva, dutina tehla, u sádkartónových dosiek alebo iných konštrukcií rámu. U týchto murív je nutné použiť špeciálne hmoždenky! Tieto je možné dostať v špeciálnych predajniach so stavebným materiálom (stavebníky). Pri nedodržaní pokynov nepreberajú výrobcovia/predajci a dodávateľa zodpovednosť za vzniknuté škody.

Upozornění! Před montáží je nutné zkontrolovat stav stěny. Přiložené univerzální hmoždinky jsou určeny pouze k použití pro pevné zdivo jako beton/cihly. Hmoždinky do zdi se nesmí používat u dutinové cihly, zdiva jako pórovitý stavební kámen, sádkartónová deska nebo jiný měkký materiál. U těchto zdiv jsou nutné použít speciální hmoždinky! Jsou k dostání v speciálních prodejnách se stavebním materiálem. Při nedodržení těchto pokynů výrobce/prodejce a dovozce neručí za způsobené škody.

Pažnja! Prije montaže obavezno provjerite svojstvo zida. Priložene univerzalne tiple namijenjene su isključivo za masivne zidove od betona/opeke. Tiple za masivne zidove ne smiju se koristiti za zidove kao npr šupljina opeka laki sastavni elementi, gips-kartonske ploče ili drugi modulami načini gradnje. Za te zidove potrebne su eventualno specijalne tiple! Iste su dostupne u specijaliziranim trgovinama građevinskim materijalom. U slučaju nepridržavanja prethodno navedenih napomena, proizvođač/trgovac i uvoznik ne preuzimaju odgovornost!

Achtung! Die Wandbeschaffenheit ist vor der Montage unbedingt zu prüfen. Die beigelegten Universaldübel sind ausschließlich nur zur Verwendung für festes Mauerwerk wie Beton/Ziegel. Die Mauerdübel dürfen nicht bei Mauerwerk wie Hohlraumziegel, Leichtbausteinen, Gipskartonplatte oder anderer Rahmenbauweise verwendet werden. Bei diesen Mauerwerken sind gegebenenfalls Spezialdübel zu verwenden! Diese sind in einem Fachgeschäft (Baumarkt) erhältlich. Bei Nichteinhaltung wird seitens Produzenten/Händler und Importeur keine Haftung übernommen.





Vigyázat! Szerelés előtt a falfelületet feltétlenül vizsgálja meg. A mellékelt univerzális tipl kizárólag stabil falazathoz használható mint például beton/tégla. A fal tipl nem használható könnyű építőkövek hez, üreg téglá, gipszkarton lapokhoz vagy más fávázás építményekhez. Ezekhez a falfelületekhez csak speciális tiplik használhatóak, melyek szaküzletekben (barkácsáruházakban) beszerezhetőek. Fentiek figyelmen kívül hagyása esetén a gyártó/kereskedő vagy forgalmazó nem vállal felelősséget.

Uwaga! Ścianę należy sprawdzić przed montażem. Dołączone uniwersalne kolki rozporowe są odpowiednie tylko do stosowania w mocnych murach, takich jak beton lub cegła. Nie rób z pomocą kółków rozporowych murowanych, takich jak pustak, lekka kostka, powierzchnie takie jak płyty gipsowo-kartonowe lub inne systemy ram. Jeśli dotyczy, muszą to być określone kolki rozporowe być użytym! Są one dostępne w specjalistycznym sklepie (sklepie ze sprzętem) niezgodność, producent / sprzedawca lub importer nie ponoszą odpowiedzialności.

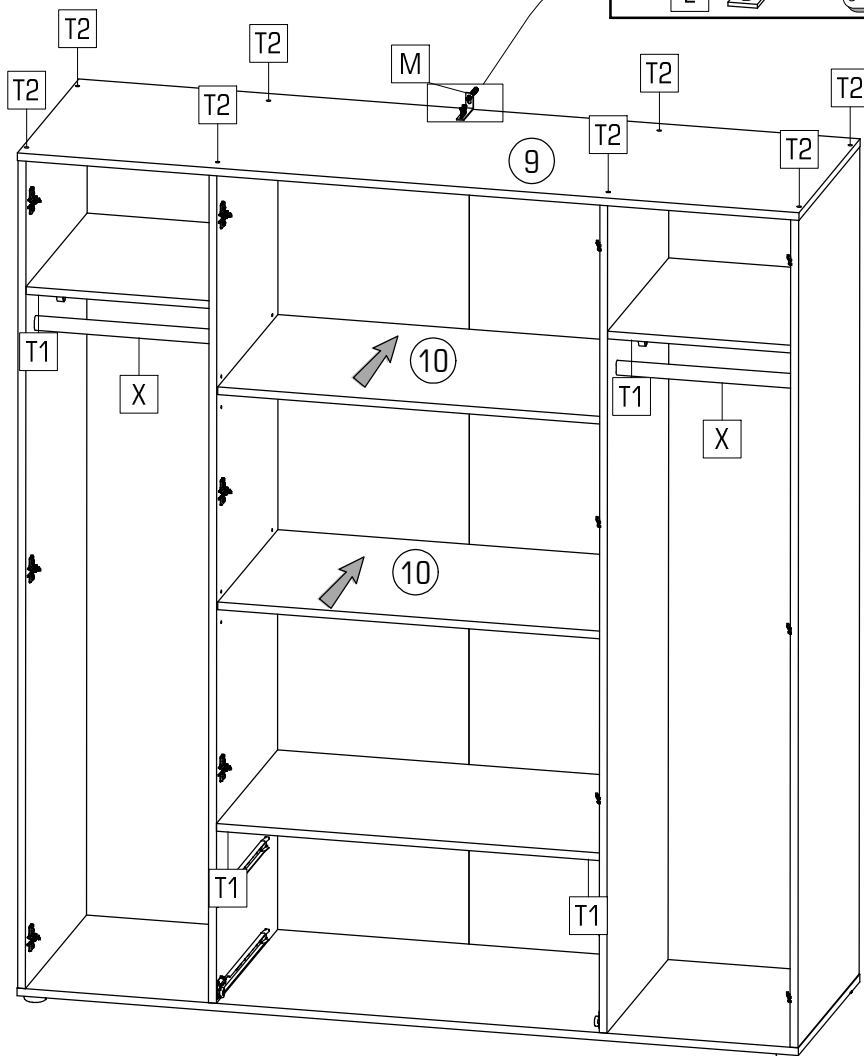
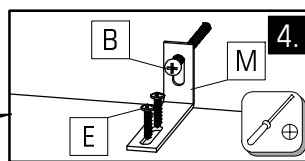
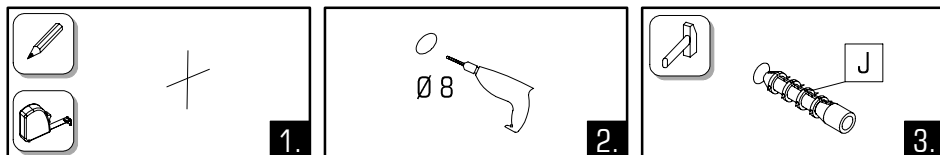
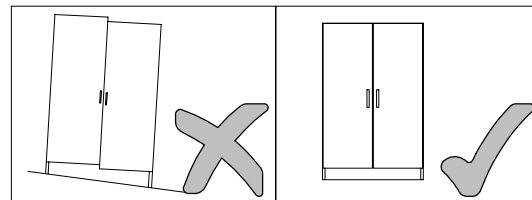
Prudentă! Zidul trebuie examinat înainte de asamblare prizele de perete sunt adecvate numai pentru utilizarea în zidărie fermă, cum ar fi betonul bloc sau cărămidă. Nu folosiți zidăria zidurilor de perete, cum ar fi cărămidă goală, blocul ușor, suprafețe cum ar fi gips-carton sau altă încadrare sisteme. Dacă este cazul, trebuie folosite anumite prize de perete! Acestea sunt disponibile la un magazin specializat (magazin de hardware). În caz de nerespectare, producătorul / vânzătorul cu amănuntul sau importatorul nu își asumă răspunderea.

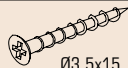
Увага! Стан стіни необхідно перевірити перед установкою. Укладені універсальні дюбелі призначені лише для використання з фіксаціями. Кладка, як бетон / цегла. Анкери для стіни не повинні використовуватися для кладки Порожни цегли, легкі будівельні блоки, гіпсокартон або інша каркасна конструкція бути використаним. З цією кладкою можуть застосовуватися спеціальні дюбелі використання! Вони доступні в спеціалізованому магазині (магазині апаратних засобів) Виробник / дилер та імпортер не несе відповідальності.

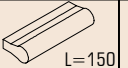

				
Ø3,5x15	Ø4x25	L=150		
D 24x	G 8x	U 4x	V1 6x	W1 6x

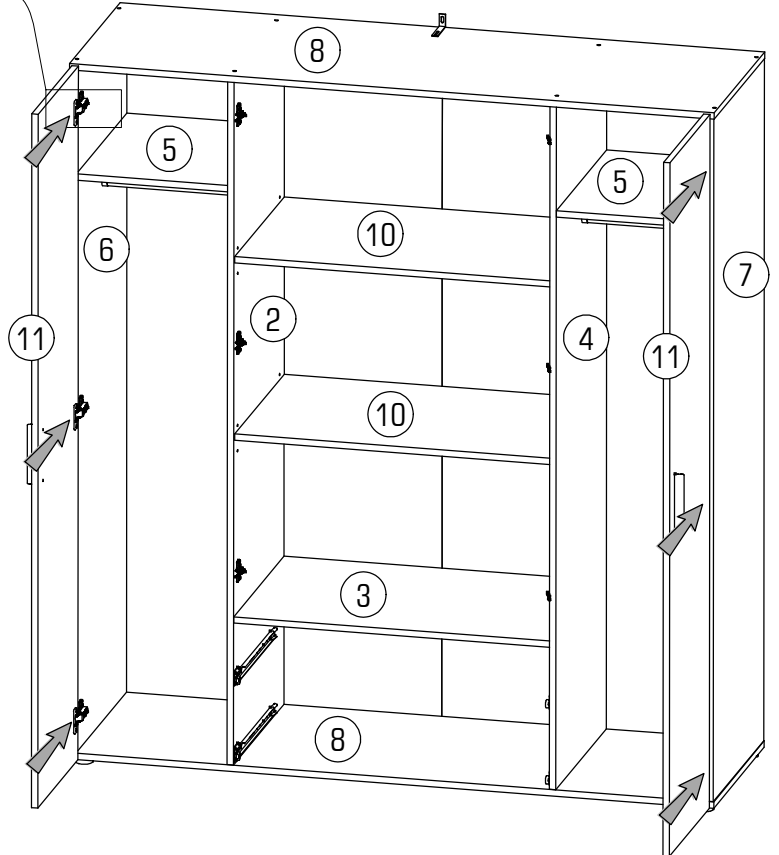
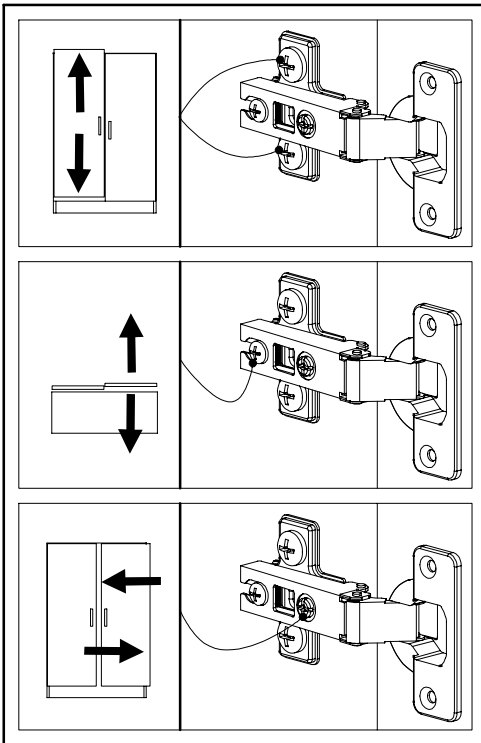
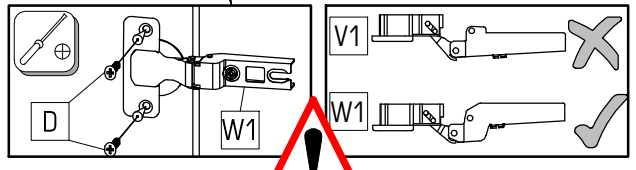
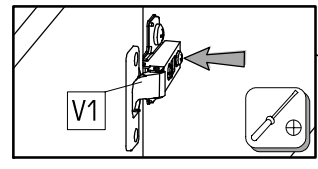
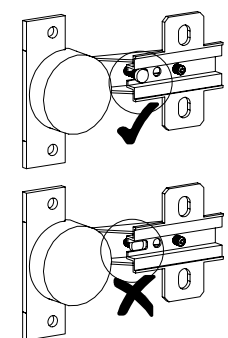
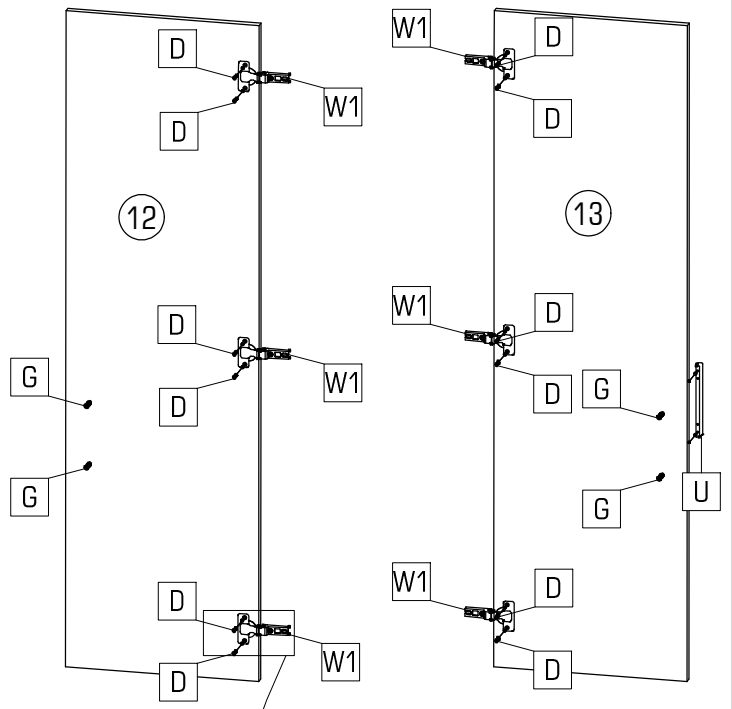
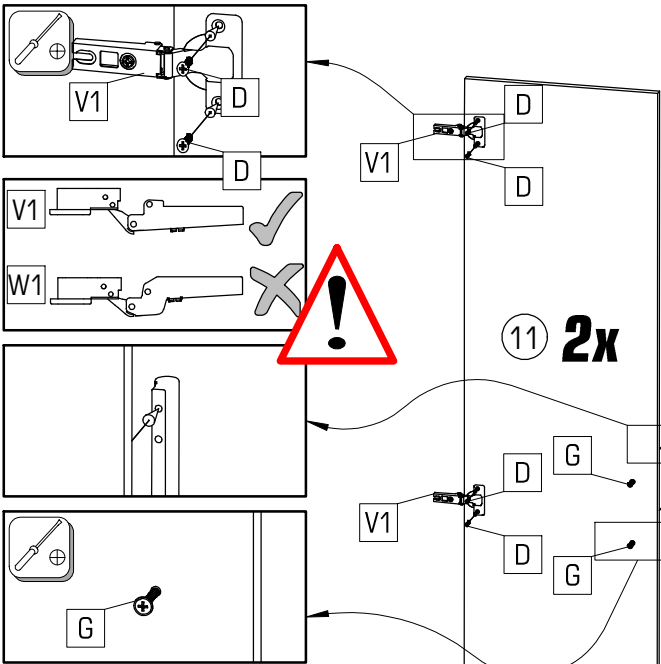

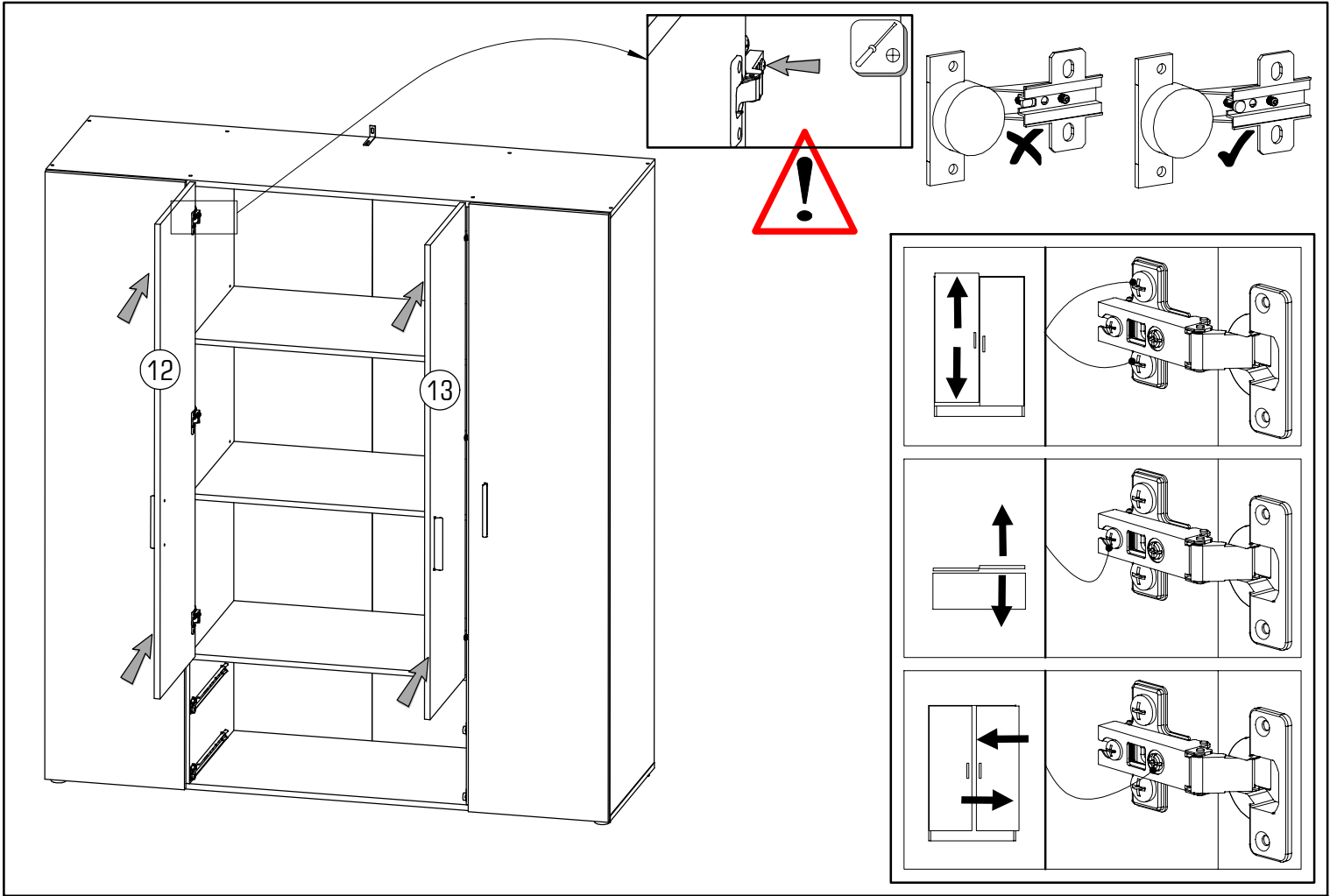

Ø4x25	Ø15x13	L=150	
G 8x	P 8x	R 8x	U 4x

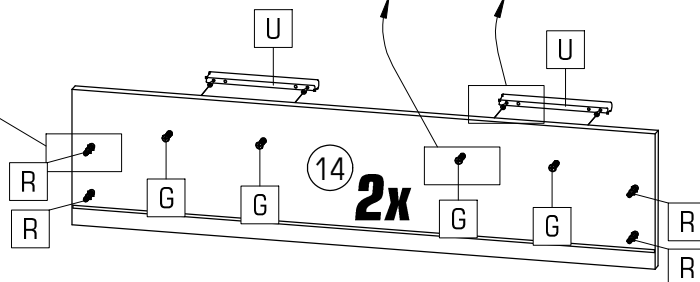
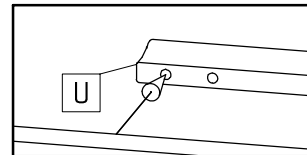
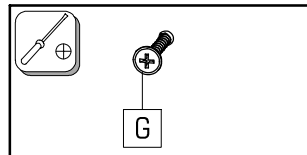
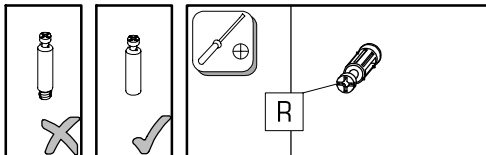
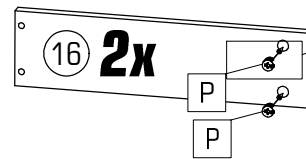
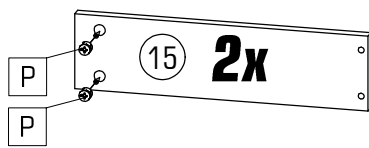
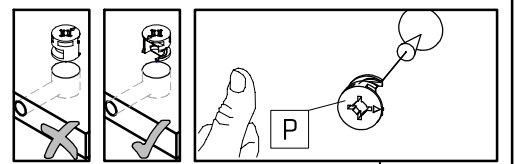



F 8x	D 12x	E 12x	T1 8x	Y2 2x

