

# LUSIANA 175

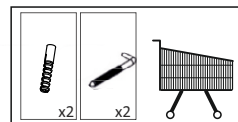

**I**

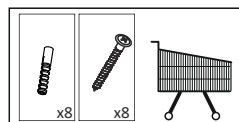
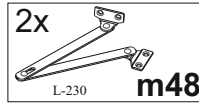
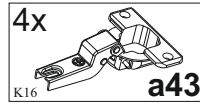
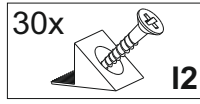
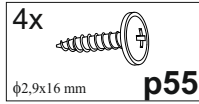
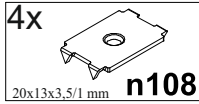
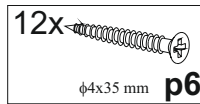
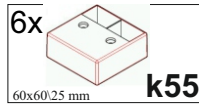
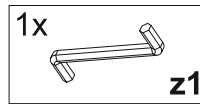
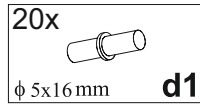
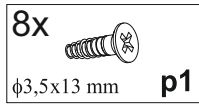
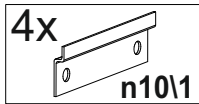
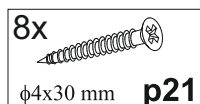
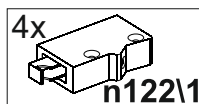
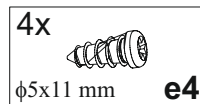
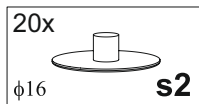
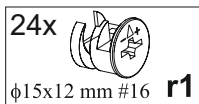
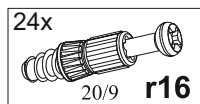
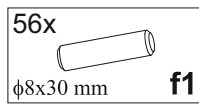
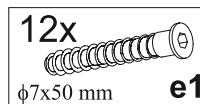
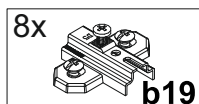
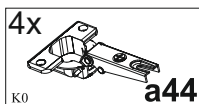
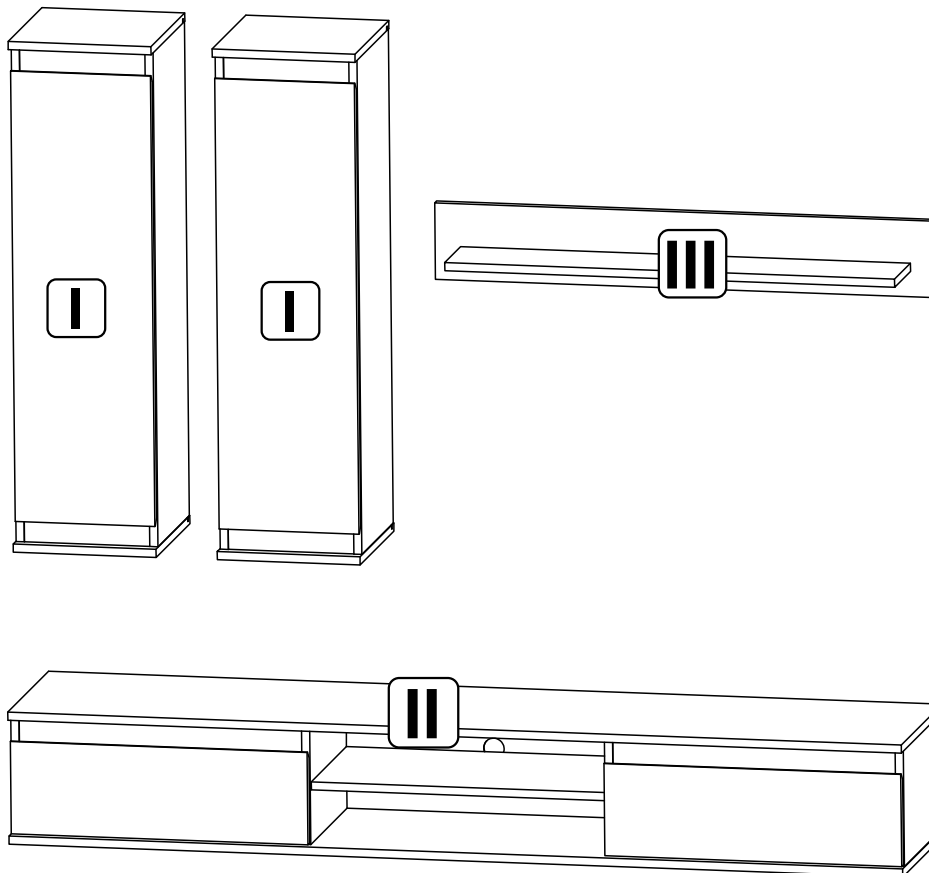
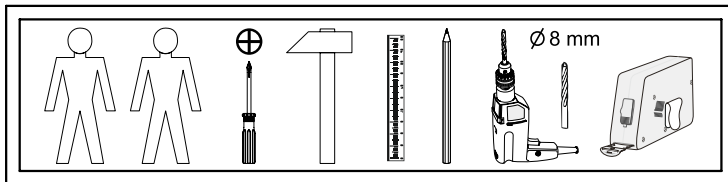
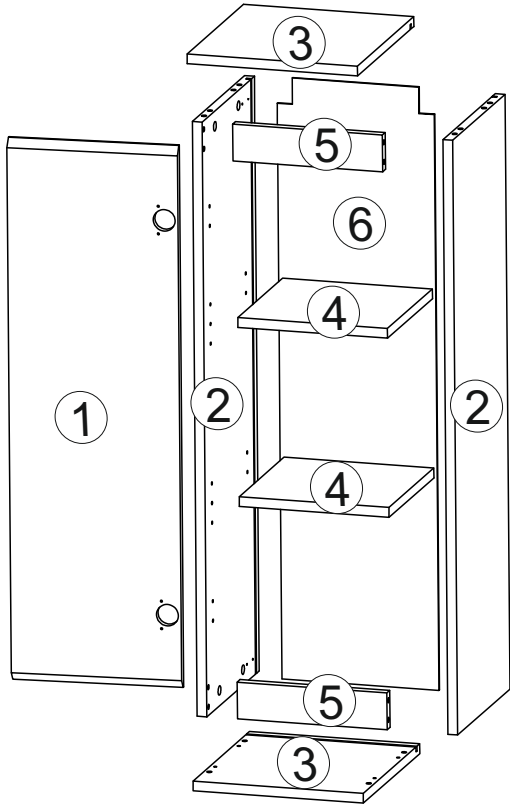

**2x**



A	B	C	D	
1	LU1-001	884	274	1/2
2	LU1-101	970	284	1/2
3	LU1-201	280	306	1/2
4	LU1-301	244	246	1/2
5	LU1-401	246	60	1/2
6	LU1-901	258	982	1/2

**1**

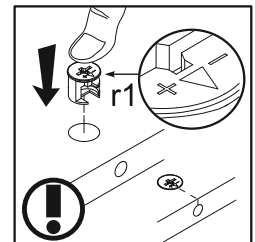
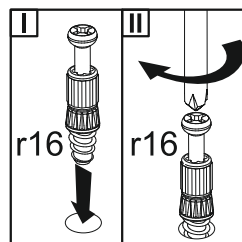
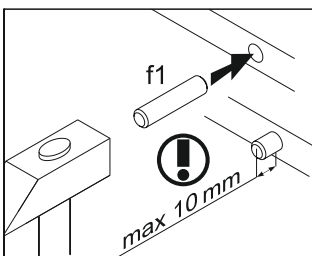
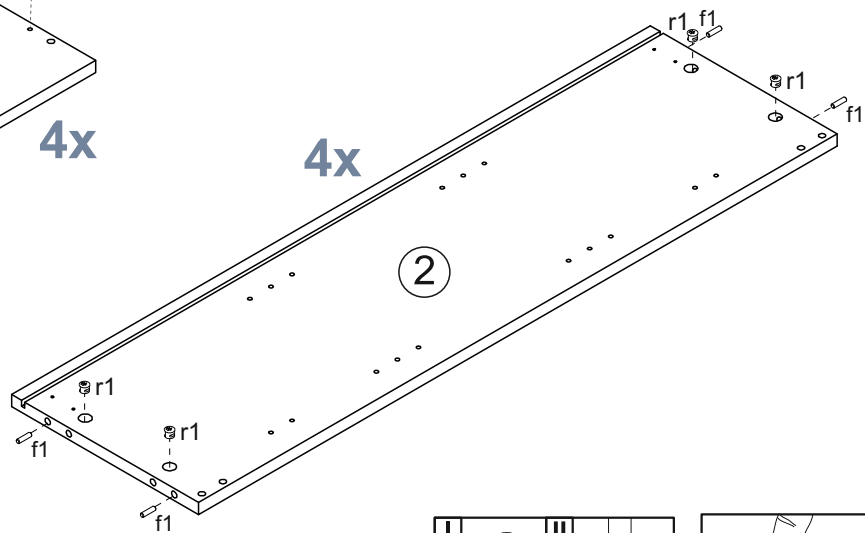
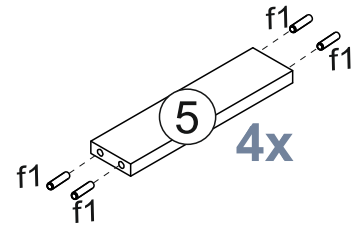
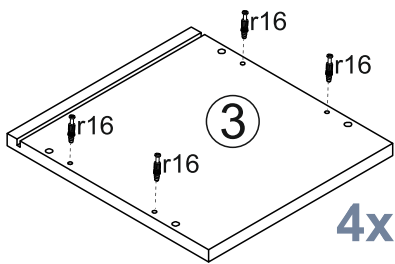
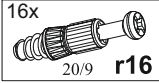
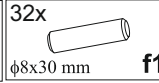

2



2x

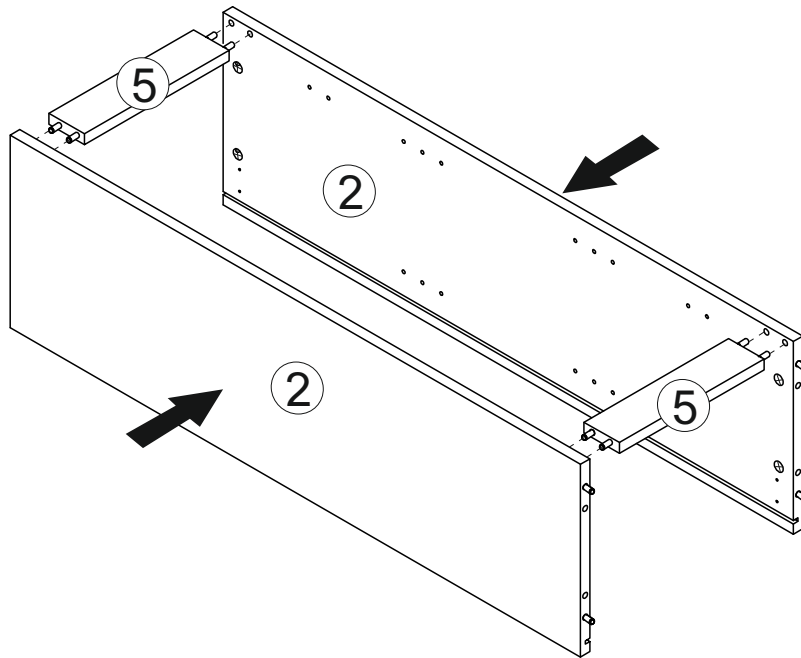

3

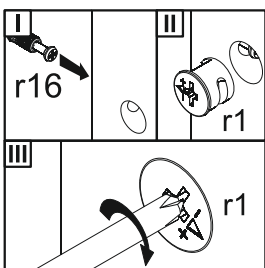
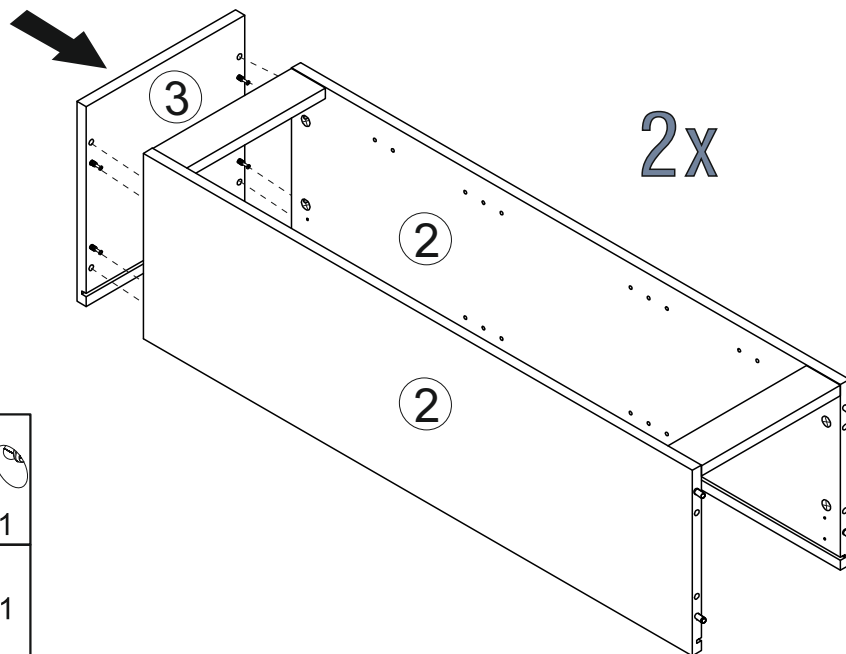

# 4

# 2x

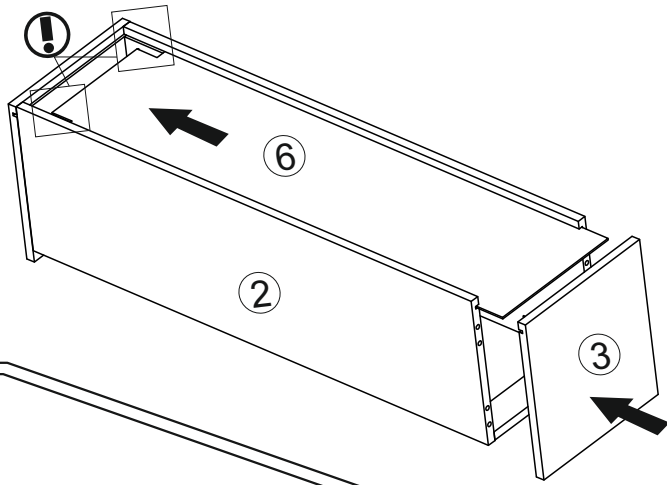
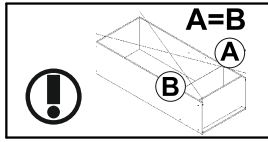

# 5

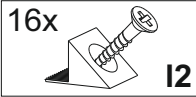

# 2x

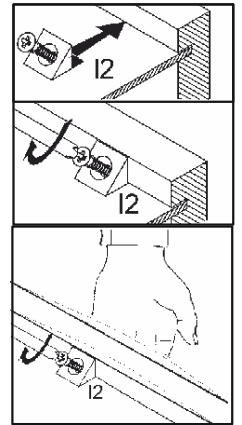
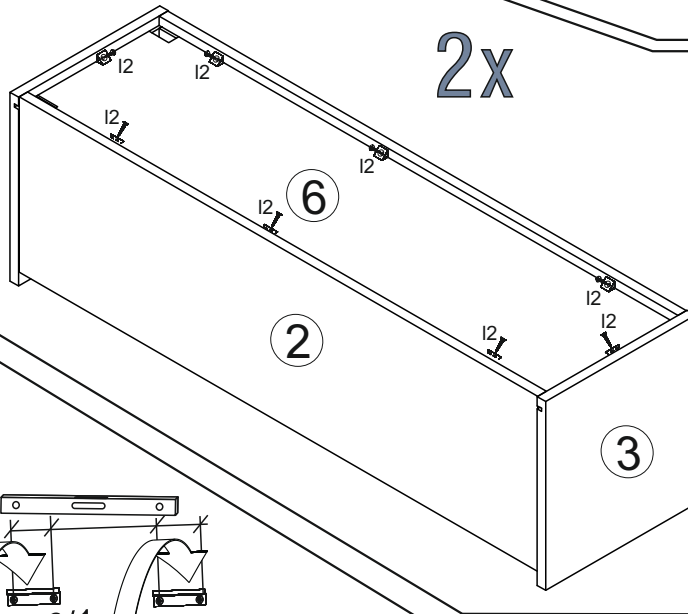
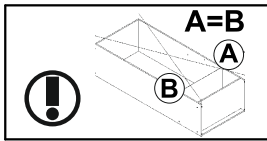

# 6

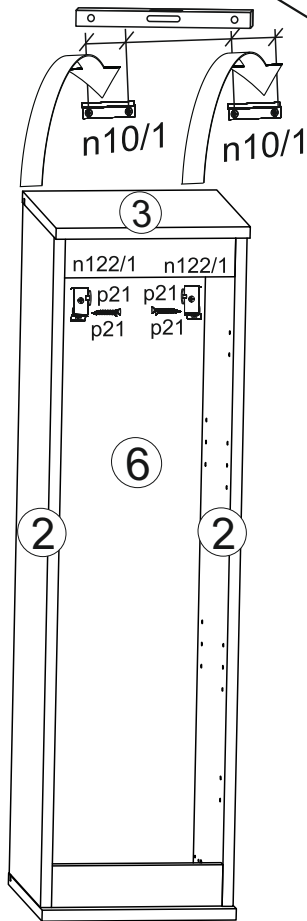
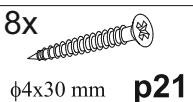
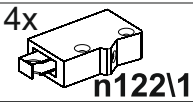
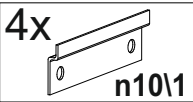
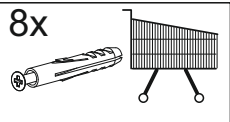

# 2x

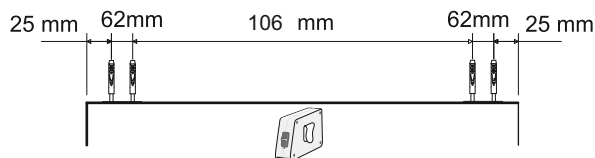
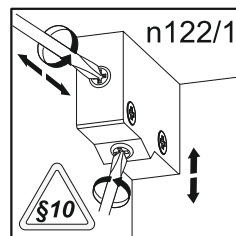
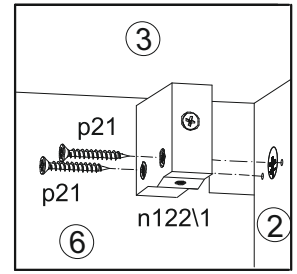
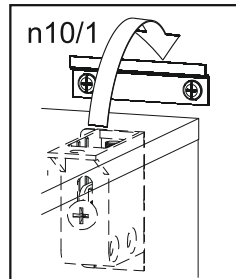
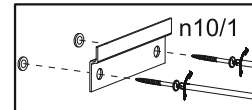
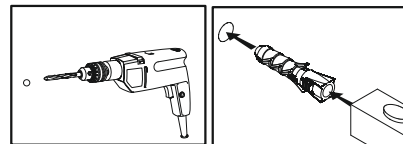

7

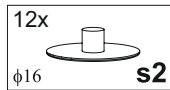
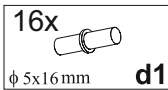
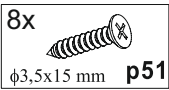
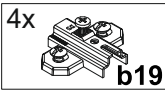
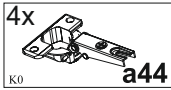

2x



REG1D\_L

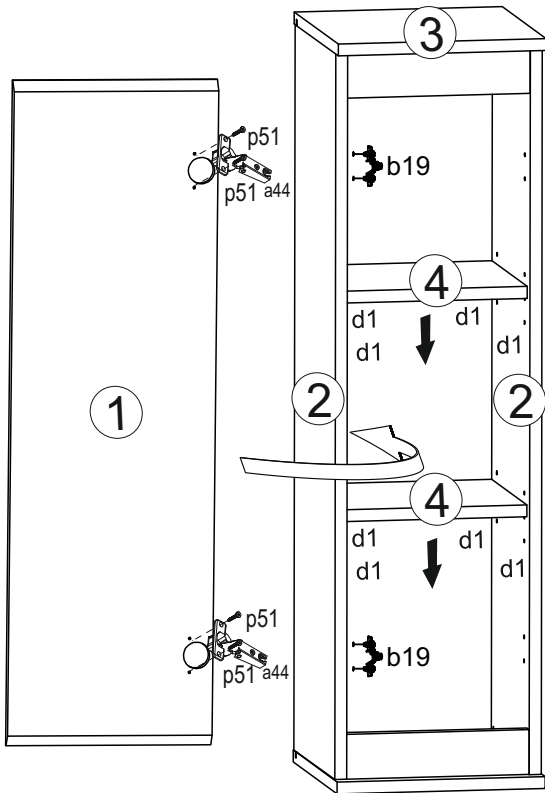

REG1D\_P

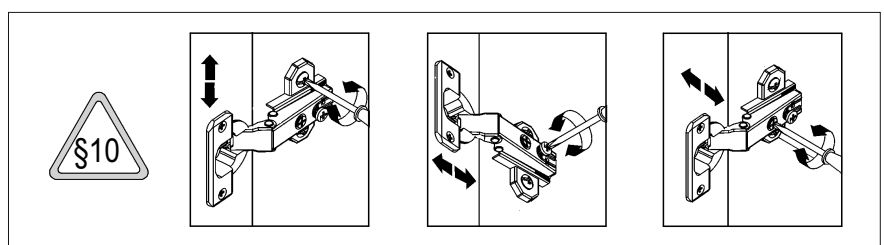
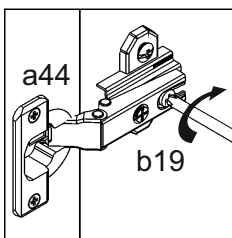
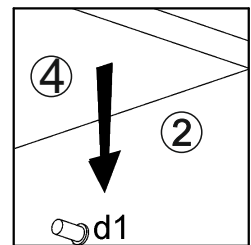
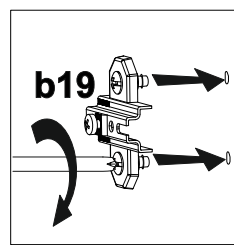
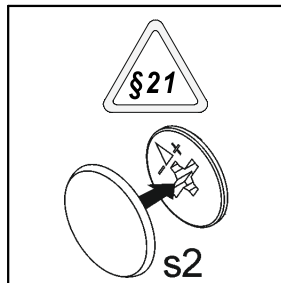
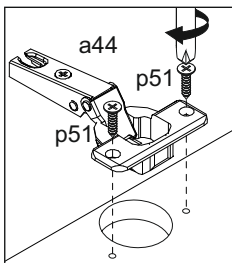
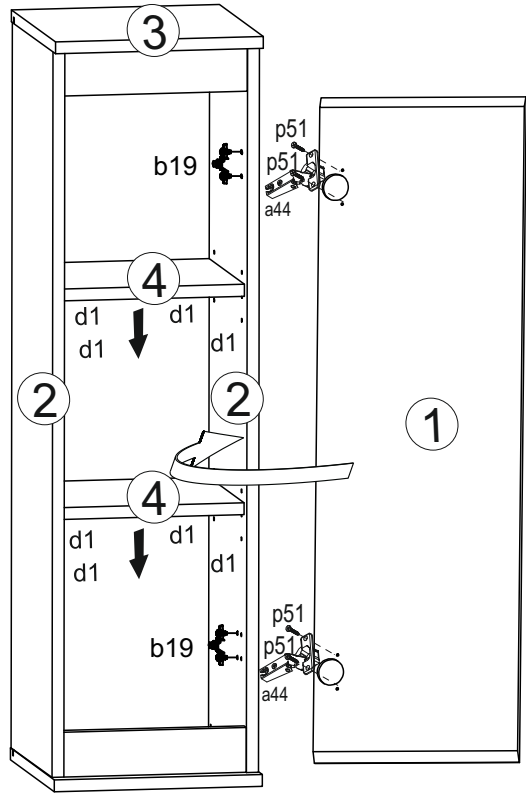

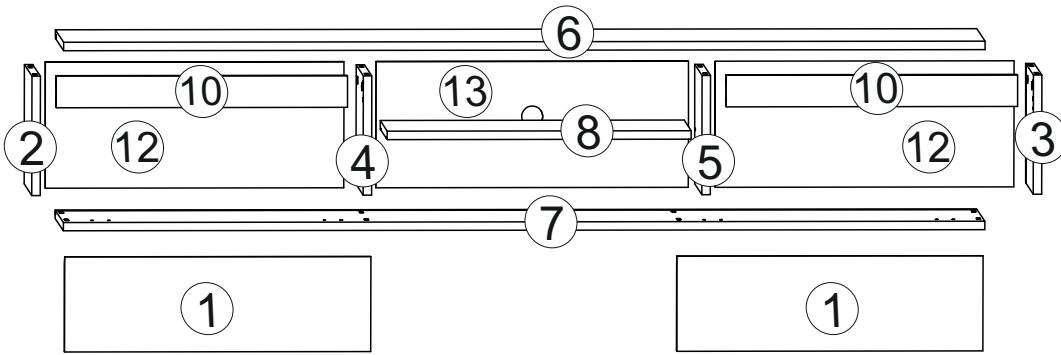

A	B	C	D	A	B	C	D		
1	LU1-002	582	181	2/2	7	LU1-203	1752	370	2/2
2	LU1-102	227	348	2/2	8	LU1-302	576	318	2/2
3	LU1-103	227	348	2/2	10	LU1-402	554	60	2/2
4	LU1-104	227	328	2/2	12	LU1-902	568	240	2/2
5	LU1-105	227	328	2/2	13	LU1-903	594	240	2/2
6	LU1-202	1752	370	2/2					

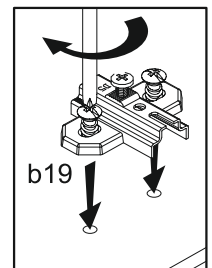
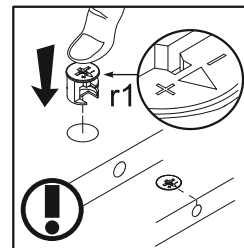
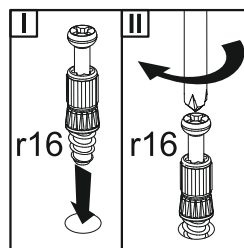
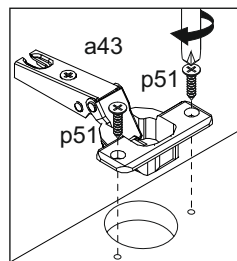
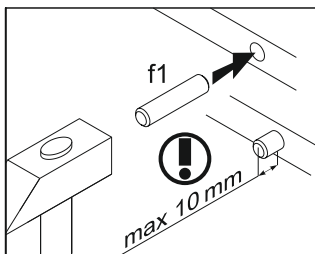
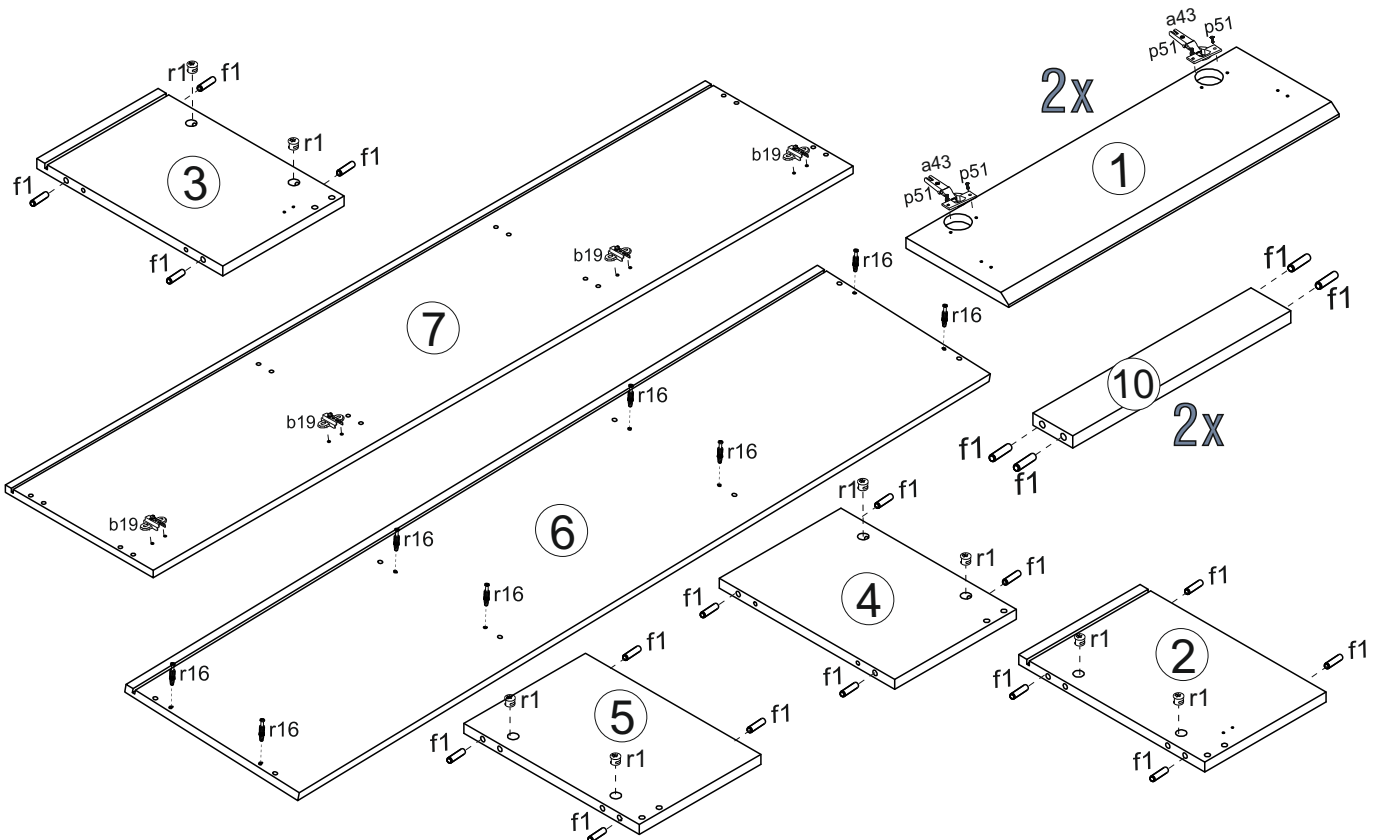
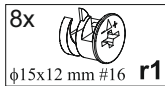
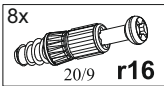
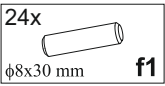
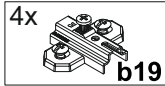
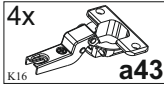

# 2

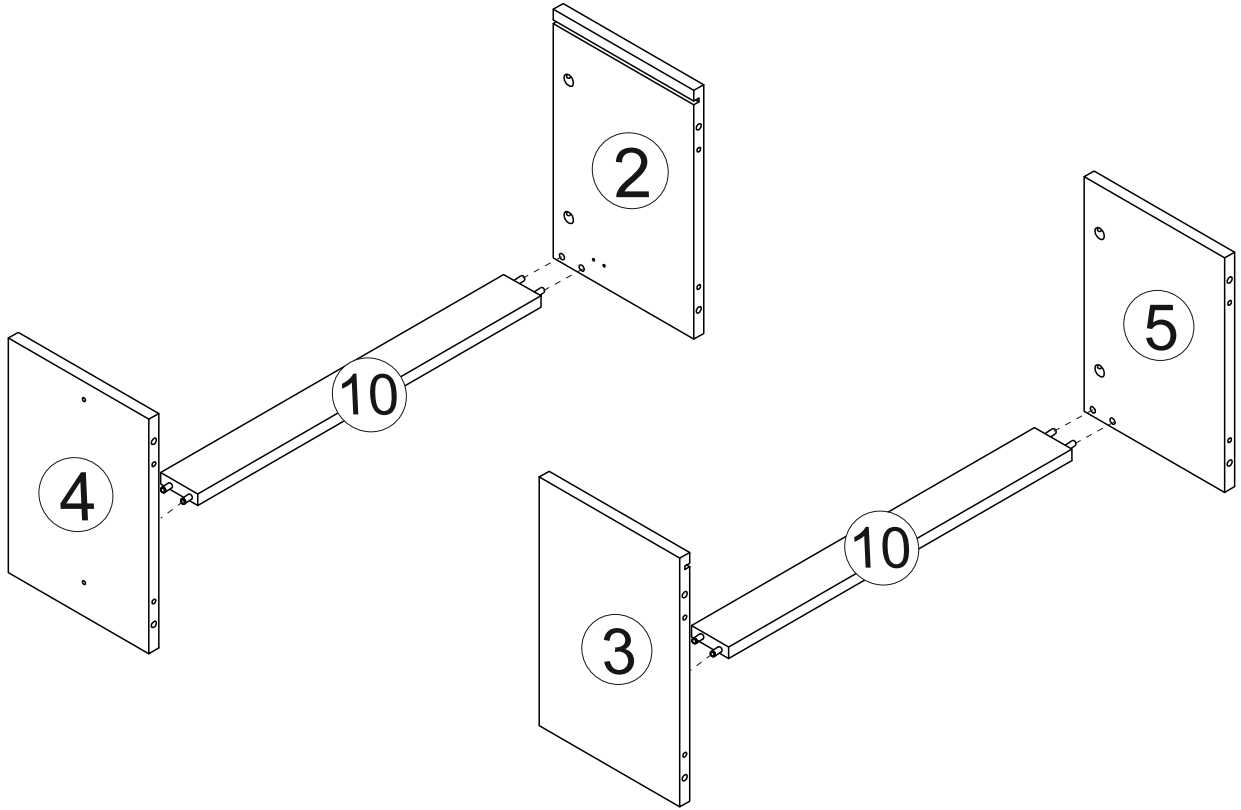

# 3

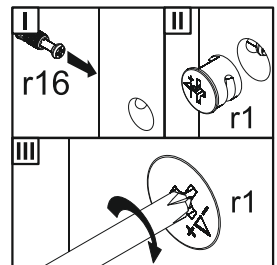
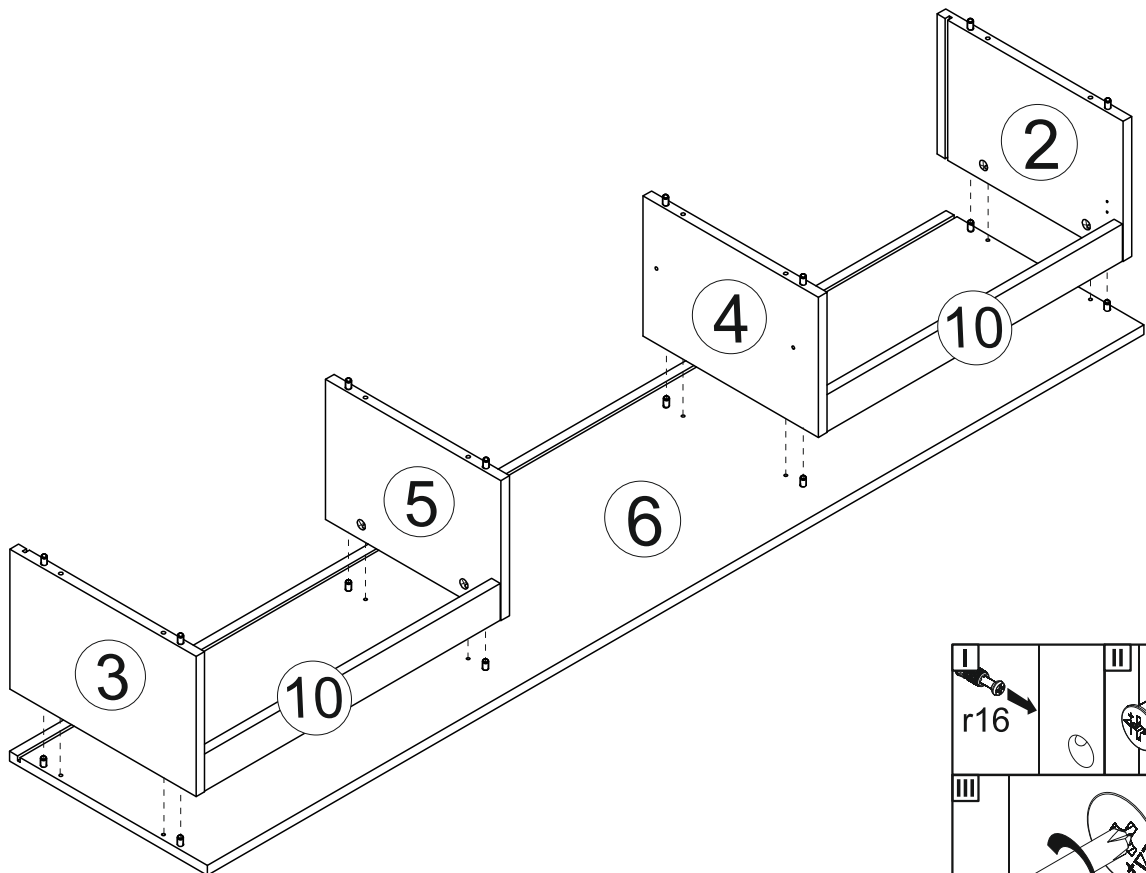

# 4

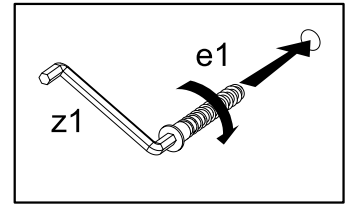
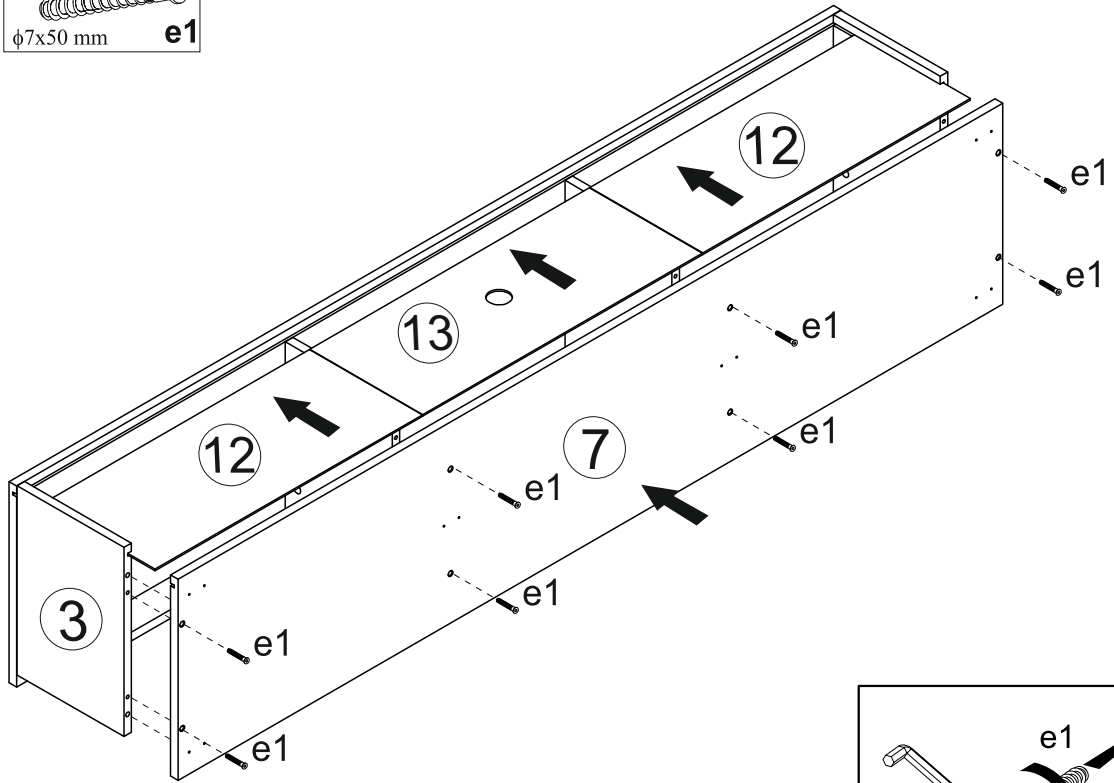
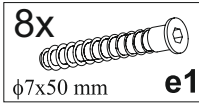

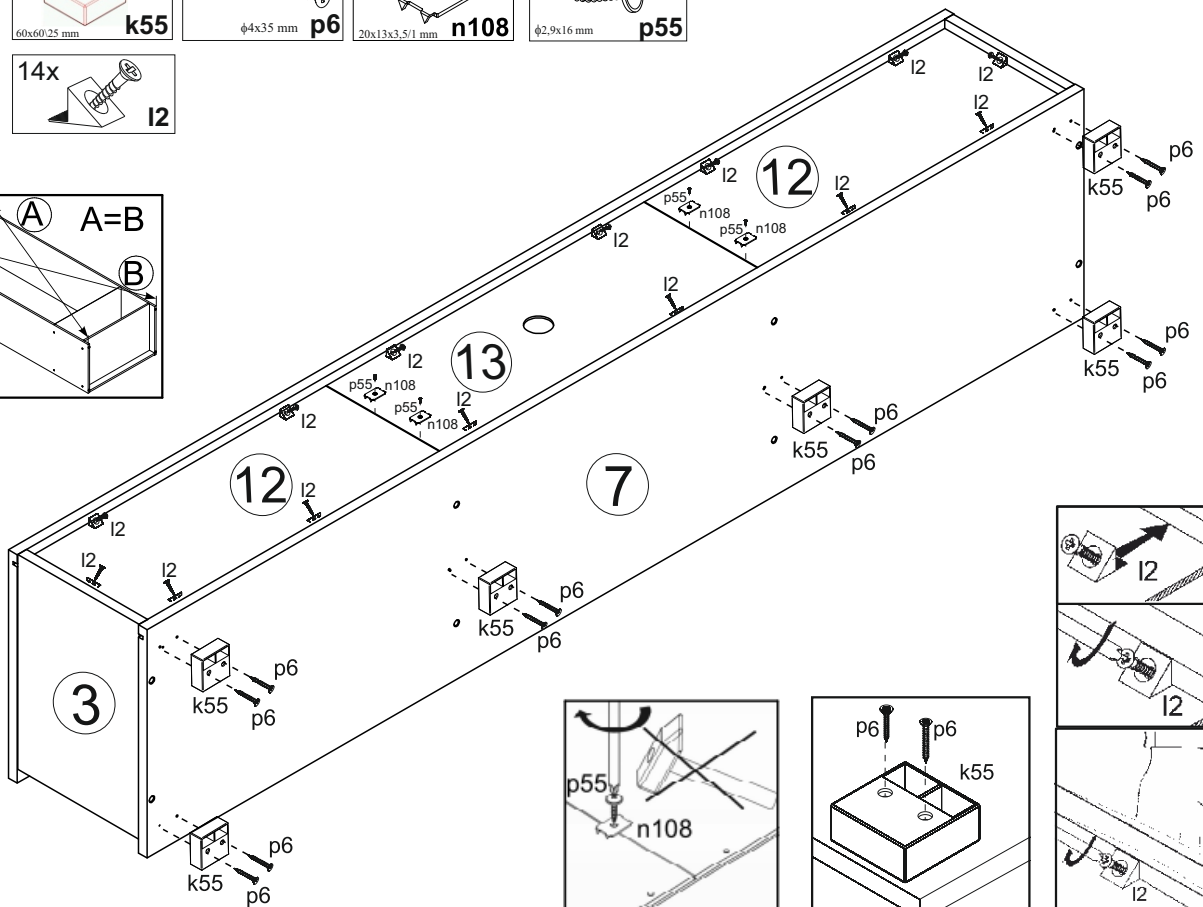
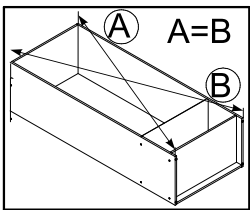
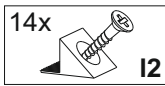
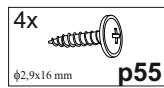
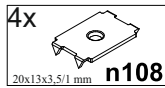
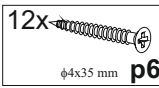
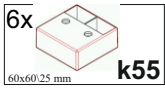

# 5







# 6

8x   $\phi 3,5 \times 13$  mm **p1**

4x   $\phi 5 \times 16$  mm **d1**

2x  L-230 **m48**

8x   $\phi 16$  **s2**

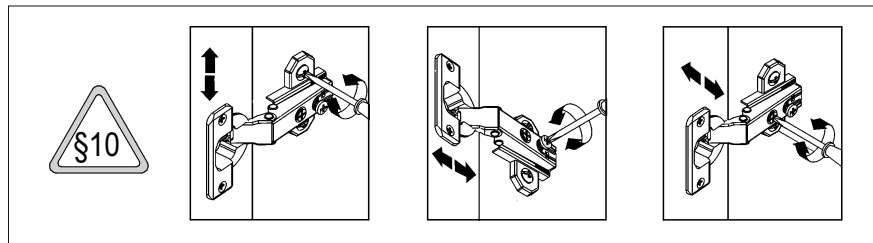
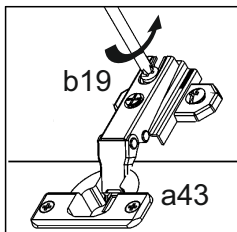
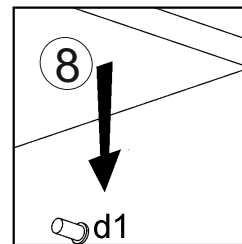
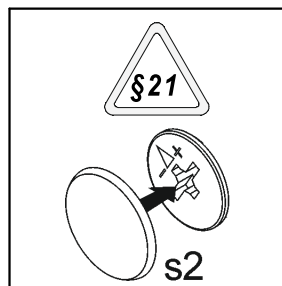
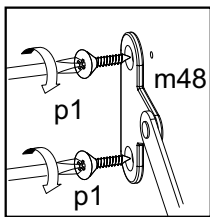
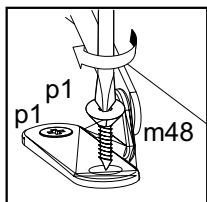
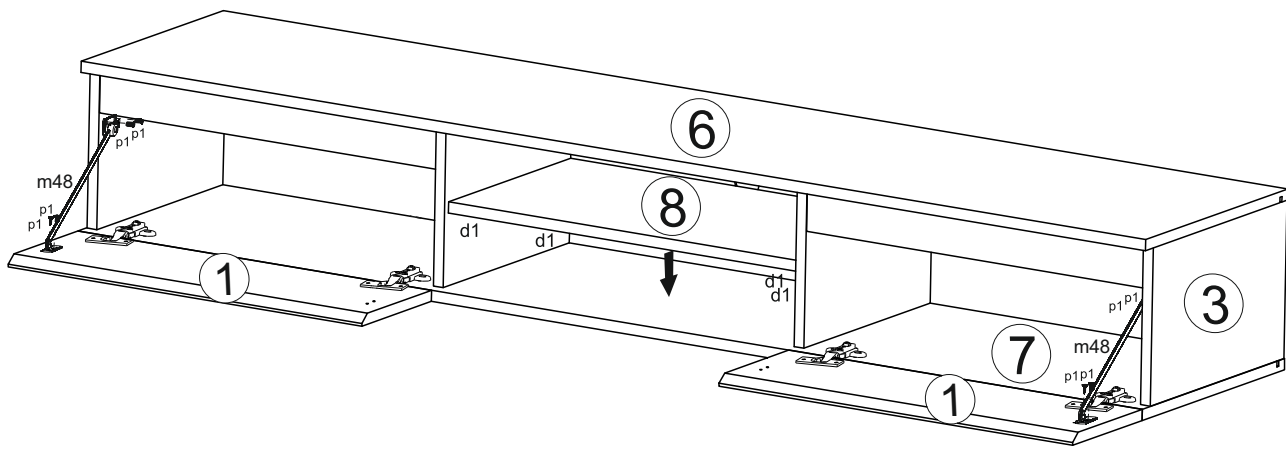



max  
3kg

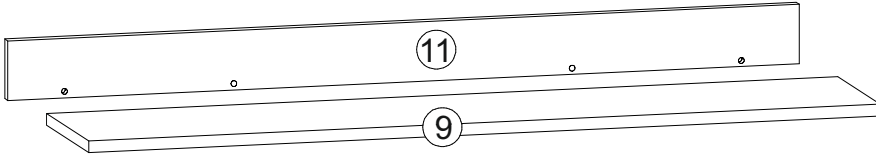

1

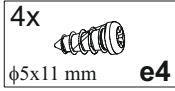
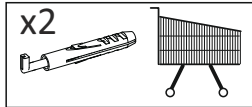
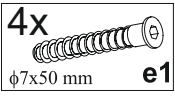

A	B	C	D
9	LU1-303	882	144
11	LU1-403	982	150

