

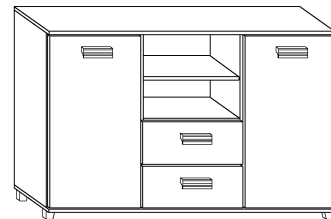

SOL-02 SOLO - KOMODA

→ 125 ↑ 86 ↘ 42



x 20



x 8

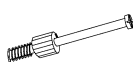

x 8



(a)

(b)

(c)

x 5

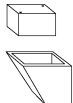

x 4

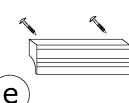

x 4

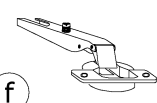

x 4

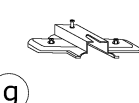

x 2 kpl. (350 mm)

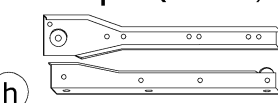

(d)

(e)

(f)

(g)

(h)

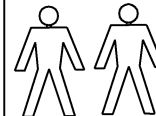

60 min

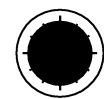

x 20



x 4



x 42
(4x16)



x 8
(3,5x30)



x 90



x 1



(i)

(j)

(k)

(l)

(m)

(n)

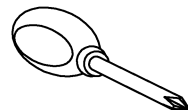
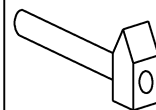

1 - FAZY MONTAŻU

A - OZNACZENIE ELEMENTÓW

a - OZNACZENIE AKCESORIÓW

1

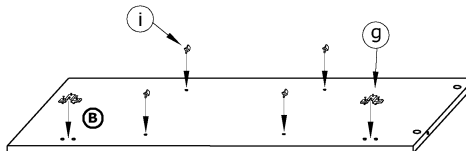
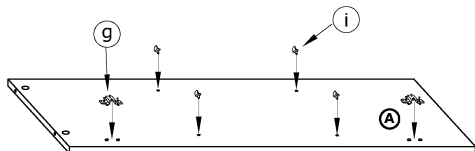

2

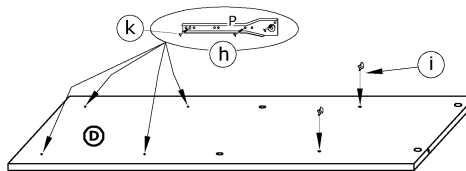
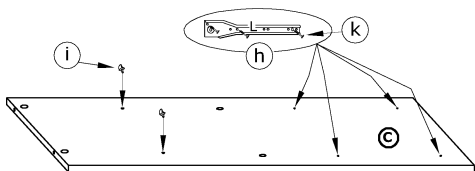

3

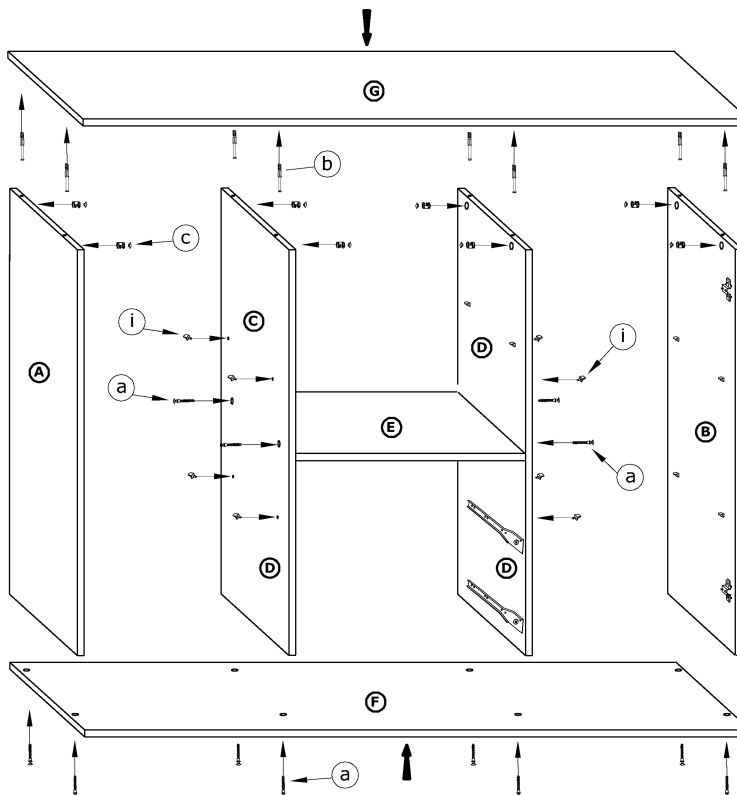

4

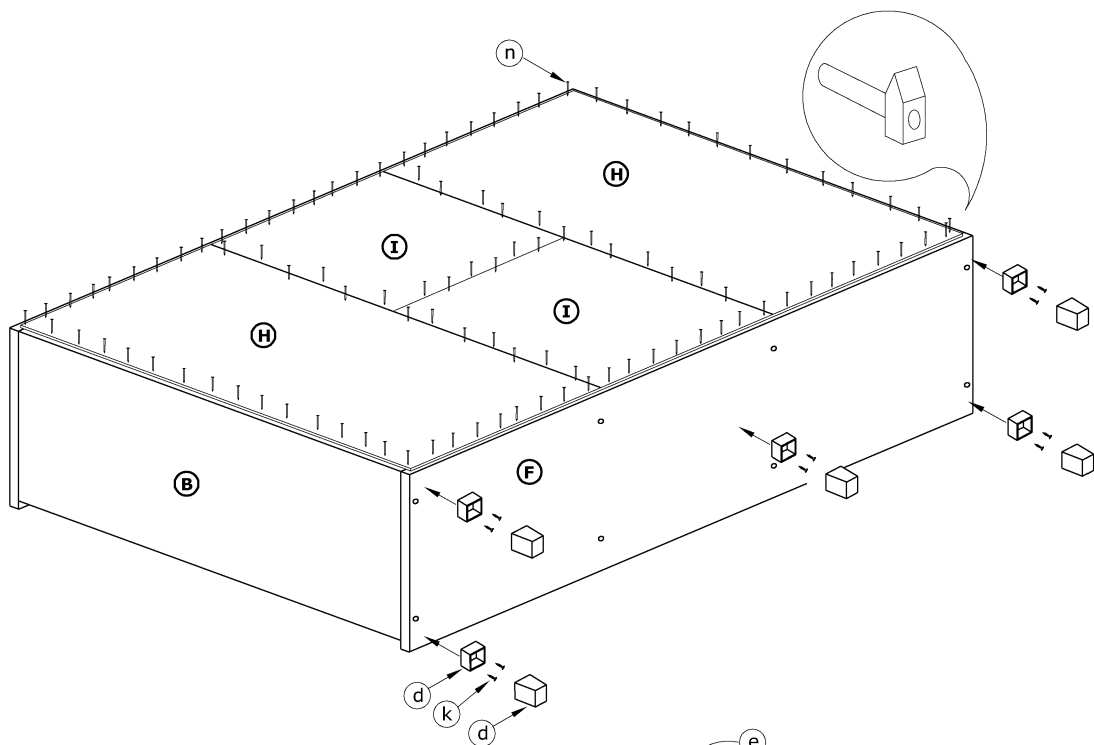

5

X 2

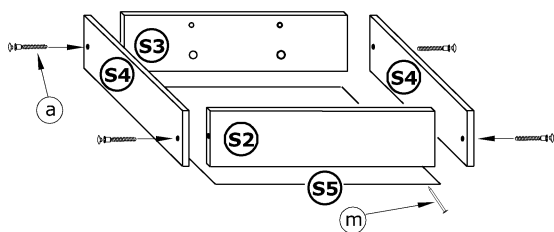

X 2

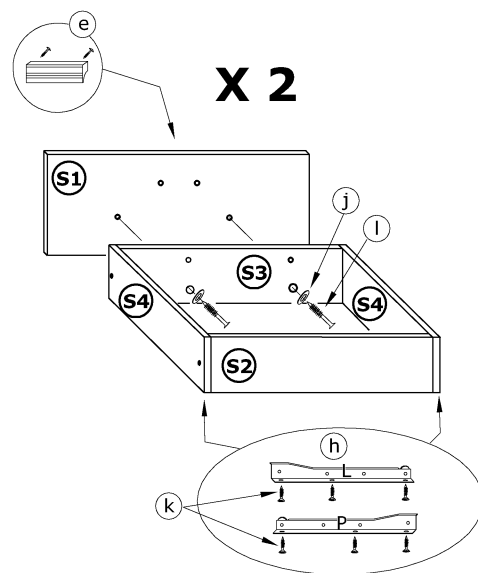

6

