

420x400x350 mm

ASSEMBLY INSTRUCTION

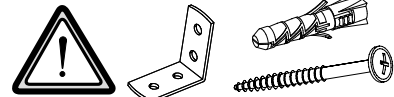
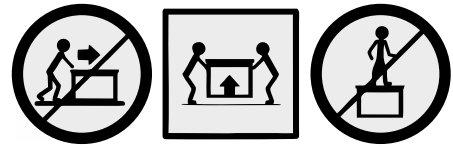

To avoid falling

we recommend fixing the product to the wall using **corners** or **double-sided tape**

Purchase separately.

OR

fill the drawers gradually from bottom to top.

Dimensions

Height: 420 mm

Width: 400 mm

Depth: 350 mm



NOTE!

For all questions and complaints about this product, please contact the place of purchase of this product.



RULES FOR USE AND CARE OF FURNITURE

1. Use furniture only in dry rooms protected from the effects of weather conditions.
2. Install with suitable tools according to these assembly instructions.
3. Try to assemble as close to the location as possible.
4. The body is assembling in a horizontal position.
5. Before moving furniture, make sure that it is not loaded with items.

Caution: moving furniture may damage it.

When moving, hold on to vertical elements only; moving furniture by horizontal parts can break the product.

6. Overloading the furniture can damage it.
7. From time to time check the fittings and their correct position.
8. Wipe the furniture surface only with a slightly damp cloth or paper towels. Do not use chemical cleaning agents other than those specifically made for this.

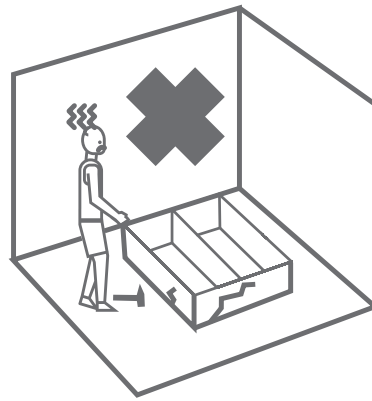
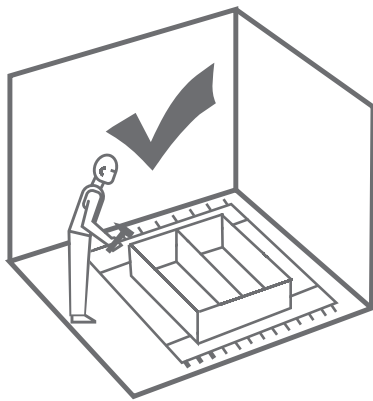
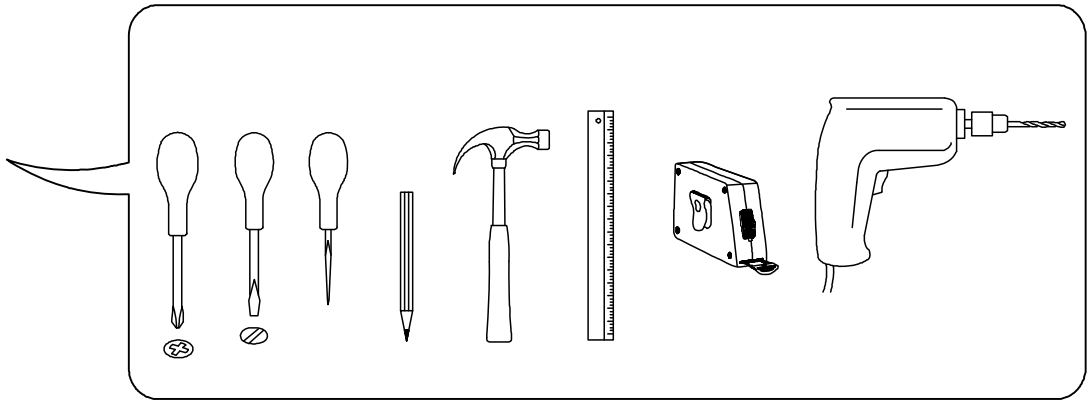

60-120 min

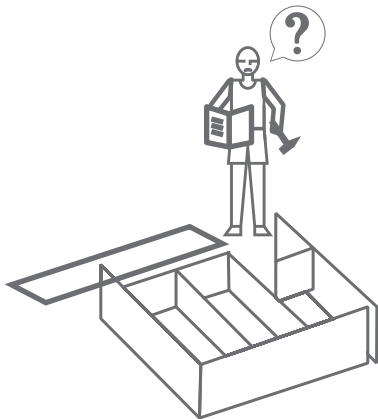
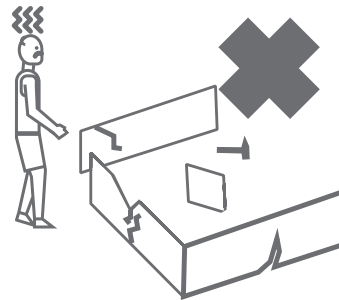
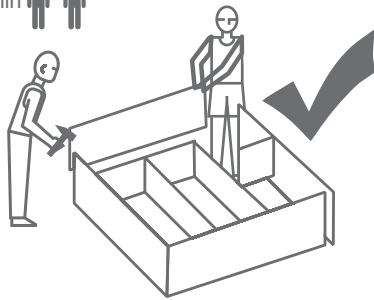

PARTS LIST

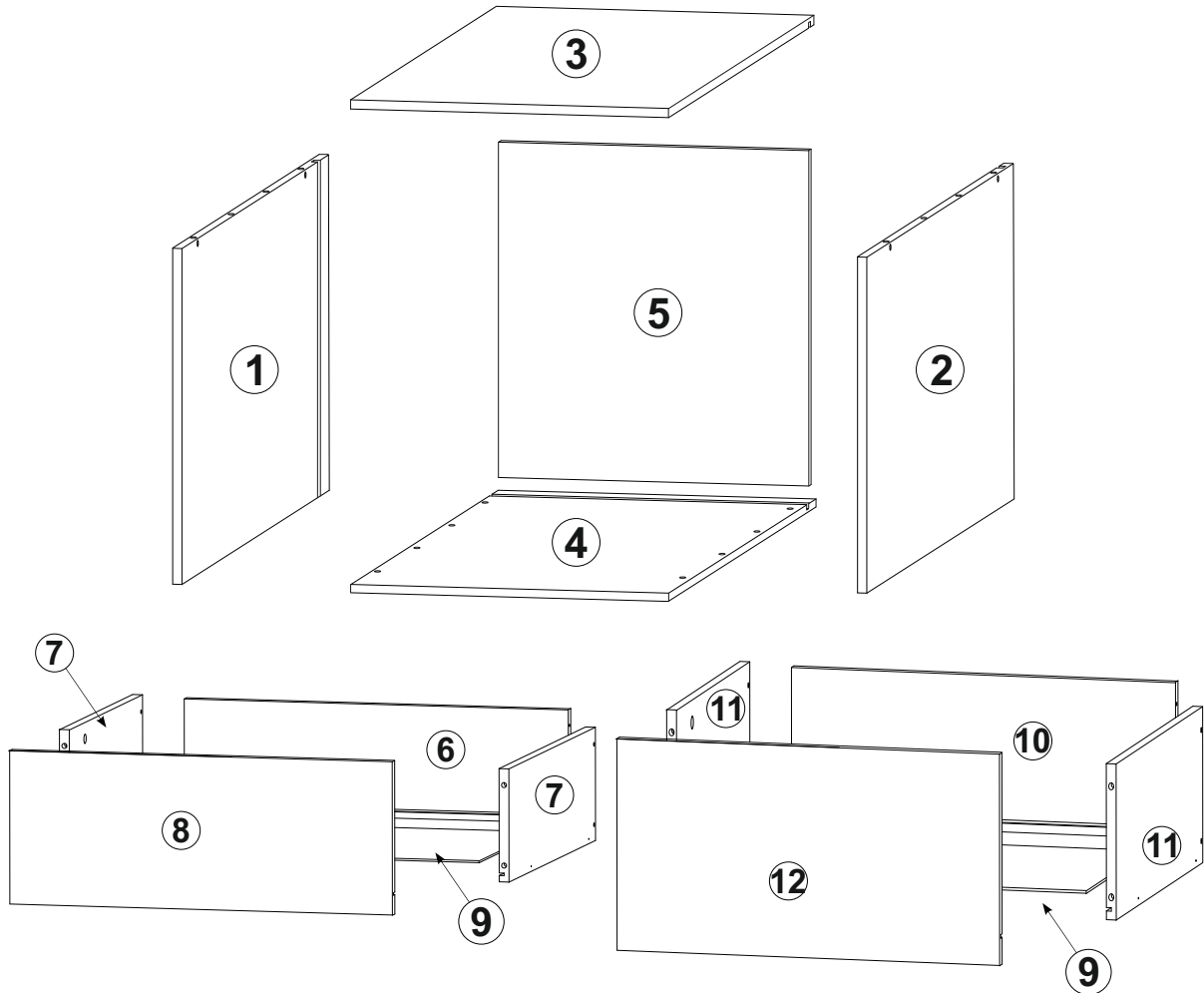

Nº	Description	Dimensions	Nº pack	Qty.
1	L.STAND	358 332	1	1
2	R.STAND	358 332	1	1
3	ROOF	400 350	1	1
4	BOTTOM	400 350	1	1
5	B.WALL	370 380	1	1

Nº	Description	Dimensions	Nº pack	Qty.
6	D.BACK	100 311	1	1
7	D.SIDE	100 300.5	1	1
8	D.FACADE	140 396	1	1
9	D.BOTTOM	323 296	1	2
10	D.BACK 2	160 311	1	1
11	D.SIDE 2	160 300.5	1	1
12	D.FACADE 2	228 396	1	1

Fittings:

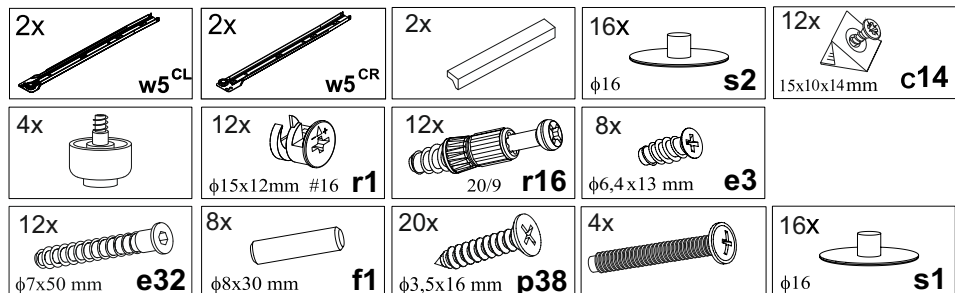

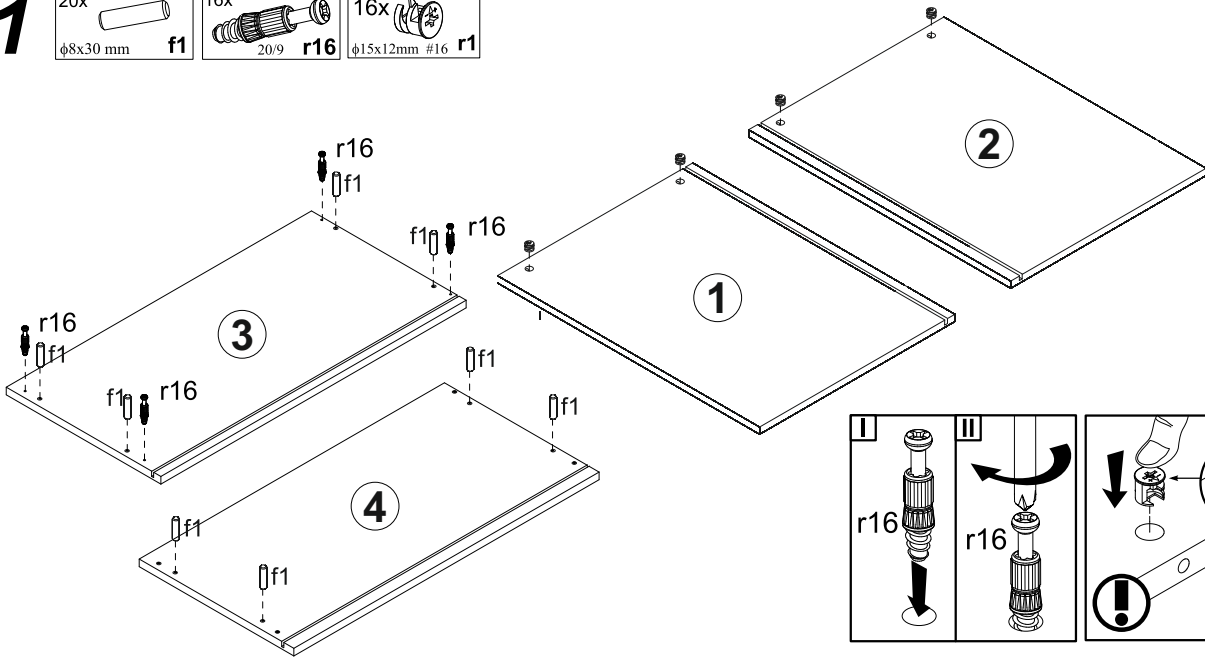
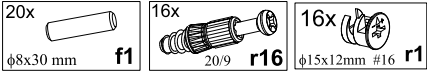
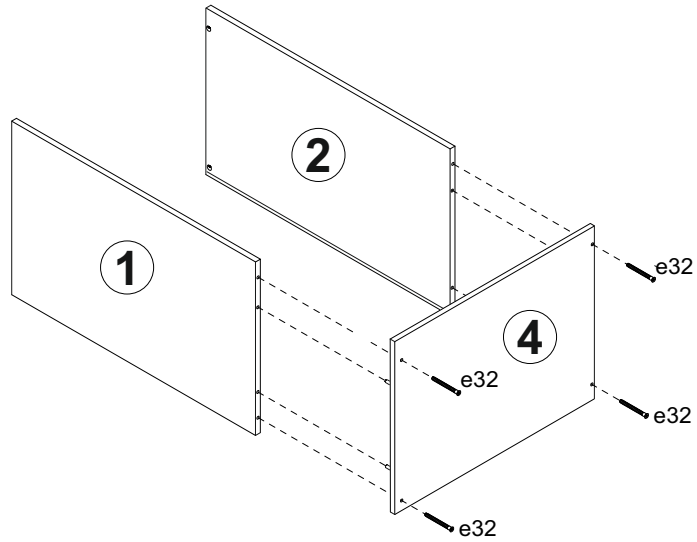
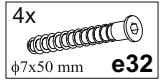
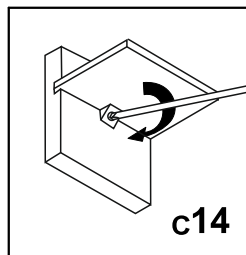
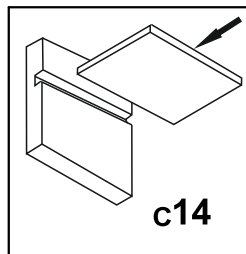
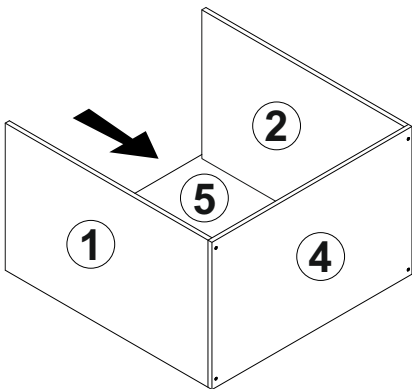
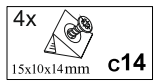
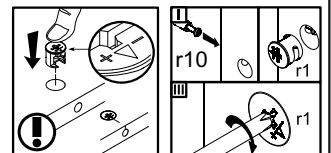
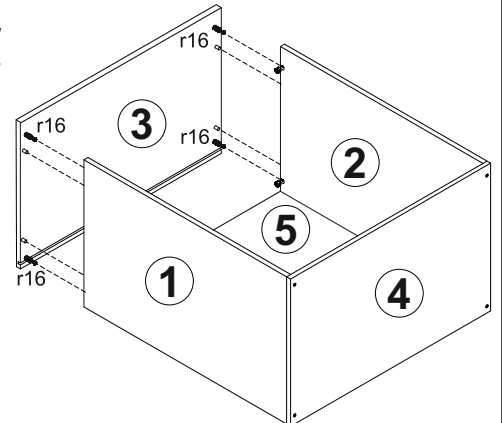
1**2****3****4**

5

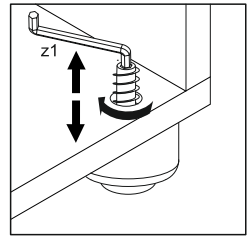
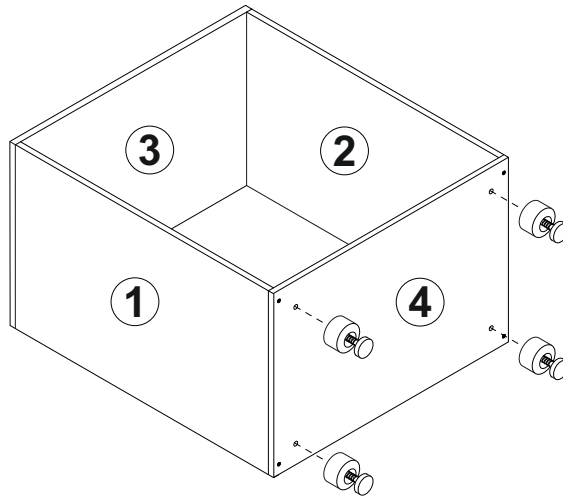
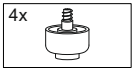

6

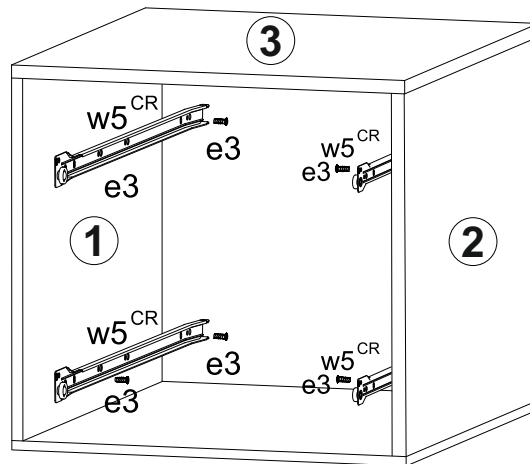
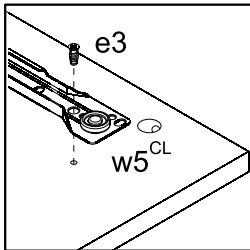
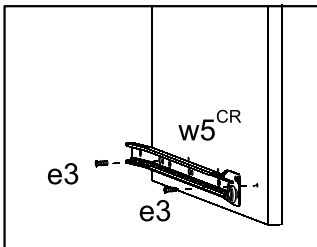
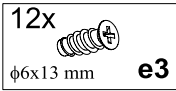

7

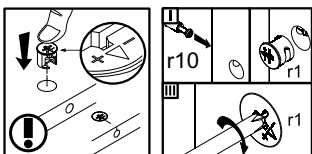
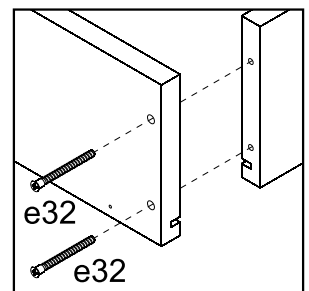
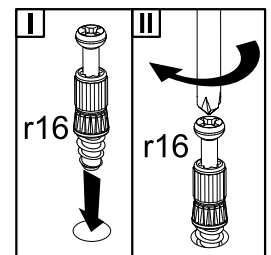
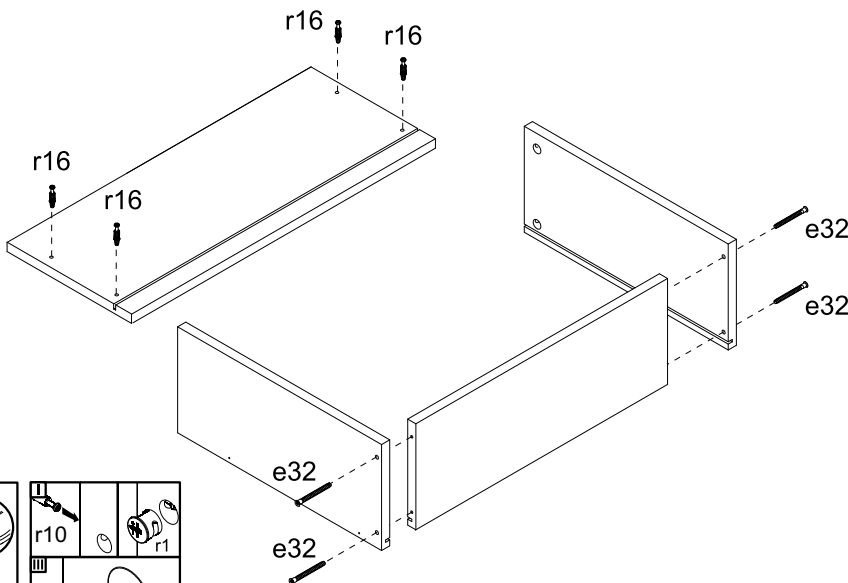
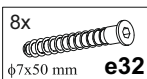
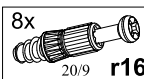

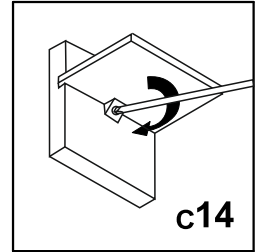
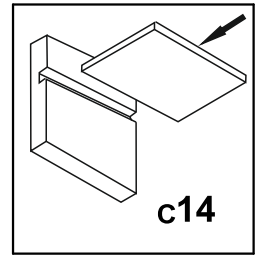
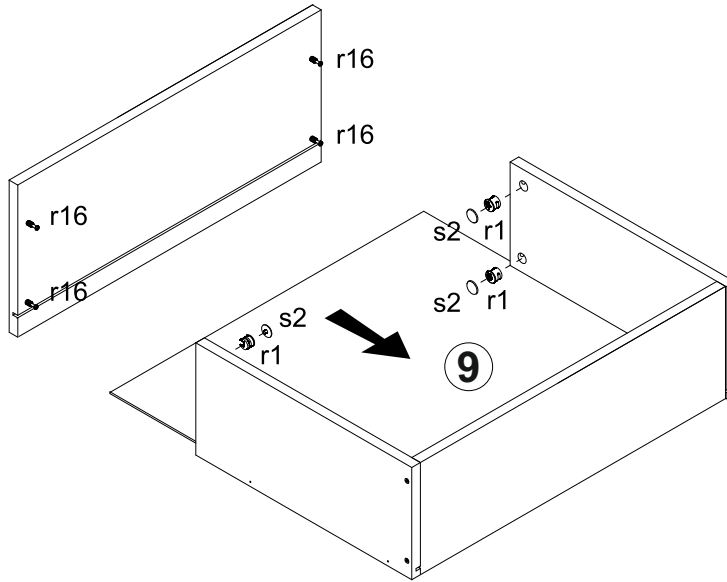

8

8x  $\phi 15 \times 12 \text{ mm}$ #16 r1



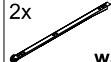

9

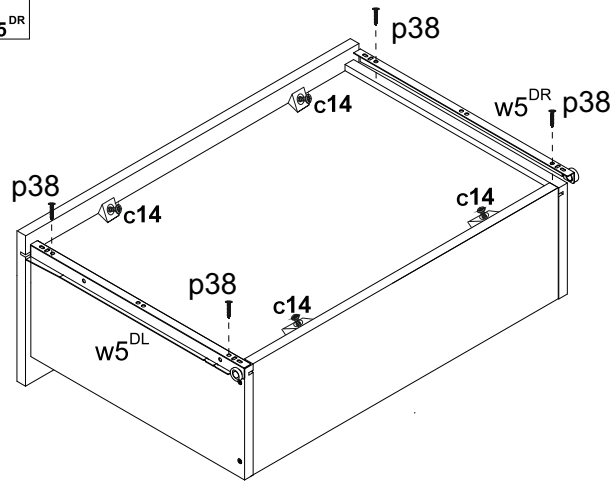
8x  $\phi 3,5 \times 16 \text{ mm}$ p38
2x  w5^{DL} 2x  w5^{DR}
8x  15x10x14mm c14



10

2x  hm1 4x  hv1

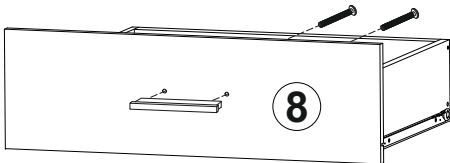

Place washers over the screws to hold the handles securely.
Washers can be found in the hardware kit.

11

