

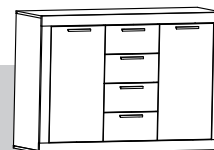

www.MLMEBLE.pl

GB D CZ SK AUS LT
assembly instructions / montageanleitung / montážní návod / montážny návod / инструкции по монтажу / surinkimo instrukcija



INSTRUKCJA MONTAŻU

MODERN 09

↑97 →138 ↘42

akcesoria / accessories / zubehör / příslušenství / príslušenstvo / аксесуары / furnitūra :

x 32 KK 8/32	x 10 KT 6,3/50	x 44 MD	x 16 ZAM	x 10 GZ 1,4/25	x 60 WTLP 3x16	x 8 WT 3,5x16	x 12 WT 4x30	x 4 ZPR	x 4 PK H-2	x 8 SP
x 8 WE 6,3x13	x 24 WE 6,3x13ES	x 8 PA Ø5	x 8 SA H20	x 6 UT 1.151	x 10 BDP	x 4 PK L-350	x 6 ZAN	x 1 klej / glue / kleber / lepidlo / lepidlo / клей / kljaj	x 1 kluczyk / key / schlüssel / klíč / ključ / ключ / raktas	

do montażu potrzebne są:
are needed for assembly:
sind erforderlich für die montage:
jsou potřebné pro montáž:
sú potrebné pre montáž:
которые необходимы для сборки:
Surinkimui reikės:

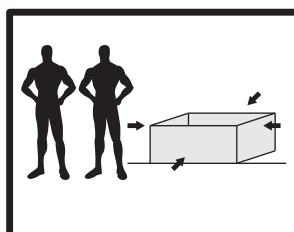
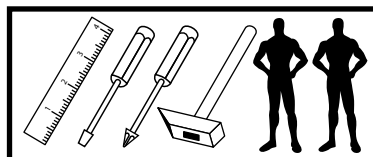

UWAGA ! - mebel należy składać w pozycji poziomej
WARNING! - furniture should be submitted in a horizontal position
WARNUNG! - Möbel sollten in einer horizontalen Position vorzulegen
POZOR! - Nábytek by měl být předložen ve vodorovné poloze
POZOR! - Nábytek by mal byť predložený vo vodorovnej polohe
ВНИМАНИЕ! - Мебель должна быть представлена в горизонтальном положении
DÉMESIO! - Baldą surenkame horizontalioje padėtyje

UWAGA ! - w pierwszej kolejności wbijamy akcesoria „KK” i „MD” w błąty oraz boki.
WARNING! - The first accessory sticks "KK" and "MD" in the tops and sides.
WARNUNG! - Die erste Accessoire-Sticks "KK" und "MD" in den Spitzen und an den Seiten.
POZOR! - První příslušenství holí "KK" a "MD" v korunách a boky.
POZOR! - Prvé príslušenstvo palíc "KK" a "MD" v korunách a boky.
ВНИМАНИЕ! - Первый аксессуаров палочки "KK" и "MD" по вершинам и по бокам.
DÉMESIO! - Pirmiausiai furnitūrą KK ir MD įkalame į stalviršį ir šonus.

Nr/No	Szt/Qty
1	1
2	1
3	1
4	1
5	1
6	1
7	2
8	1
9	2
10	2
11	2
12	1
13	2
14	1
15	1
16	1
17	2
18	2
19	2
20	2
21	2
22	2

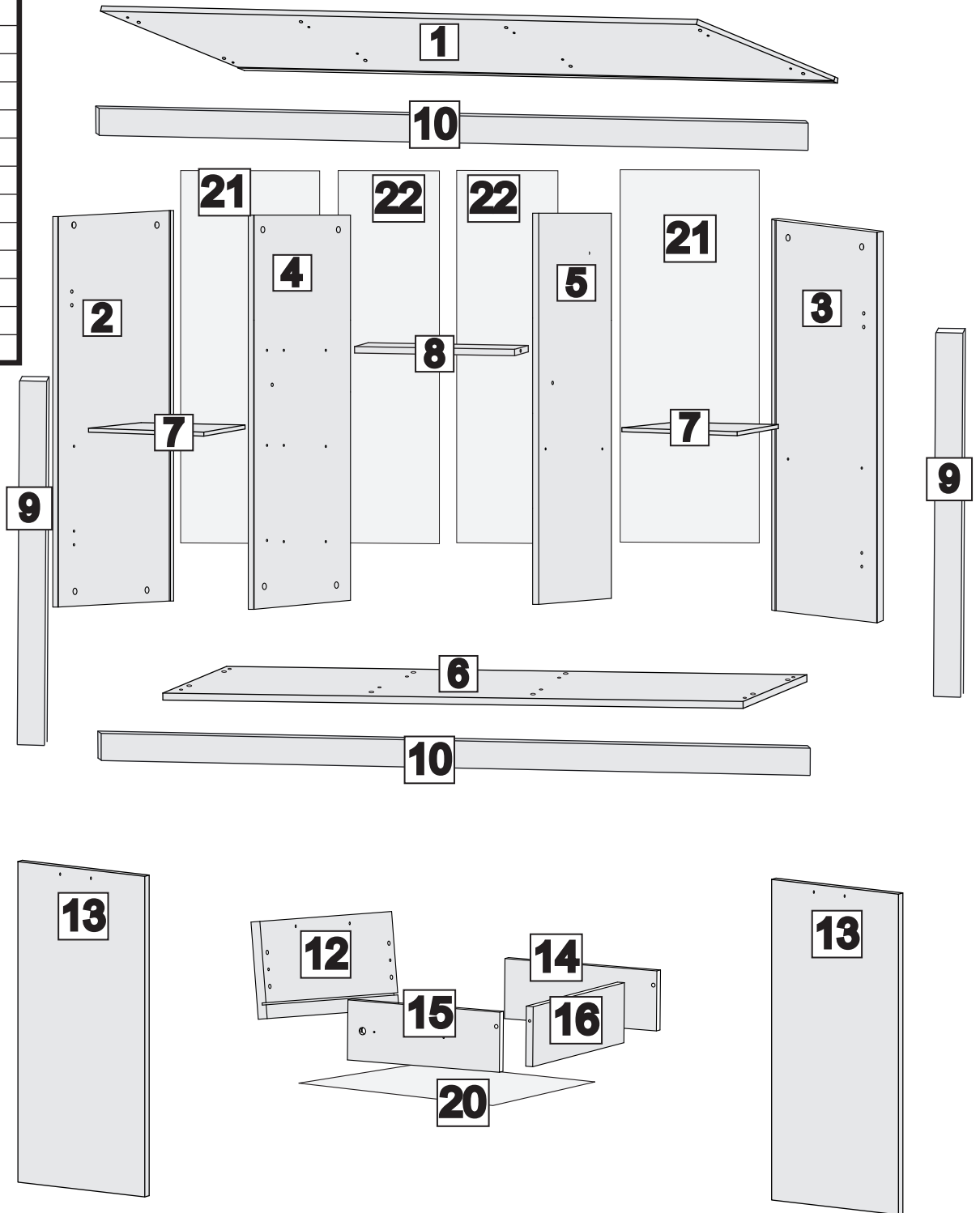

! UWAGA! - Wypinanie prowadnicy
! WARNING! - guides disassembling
! WARNUNG! - Ausstecken Führer
POZOR! - vytažení pojezdů
POZOR! - sprievodca pre montáž nábytku
ВНИМАНИЕ! - демонтаж направляющих
DĒMESIO! - Išrinkimas atskyrimas

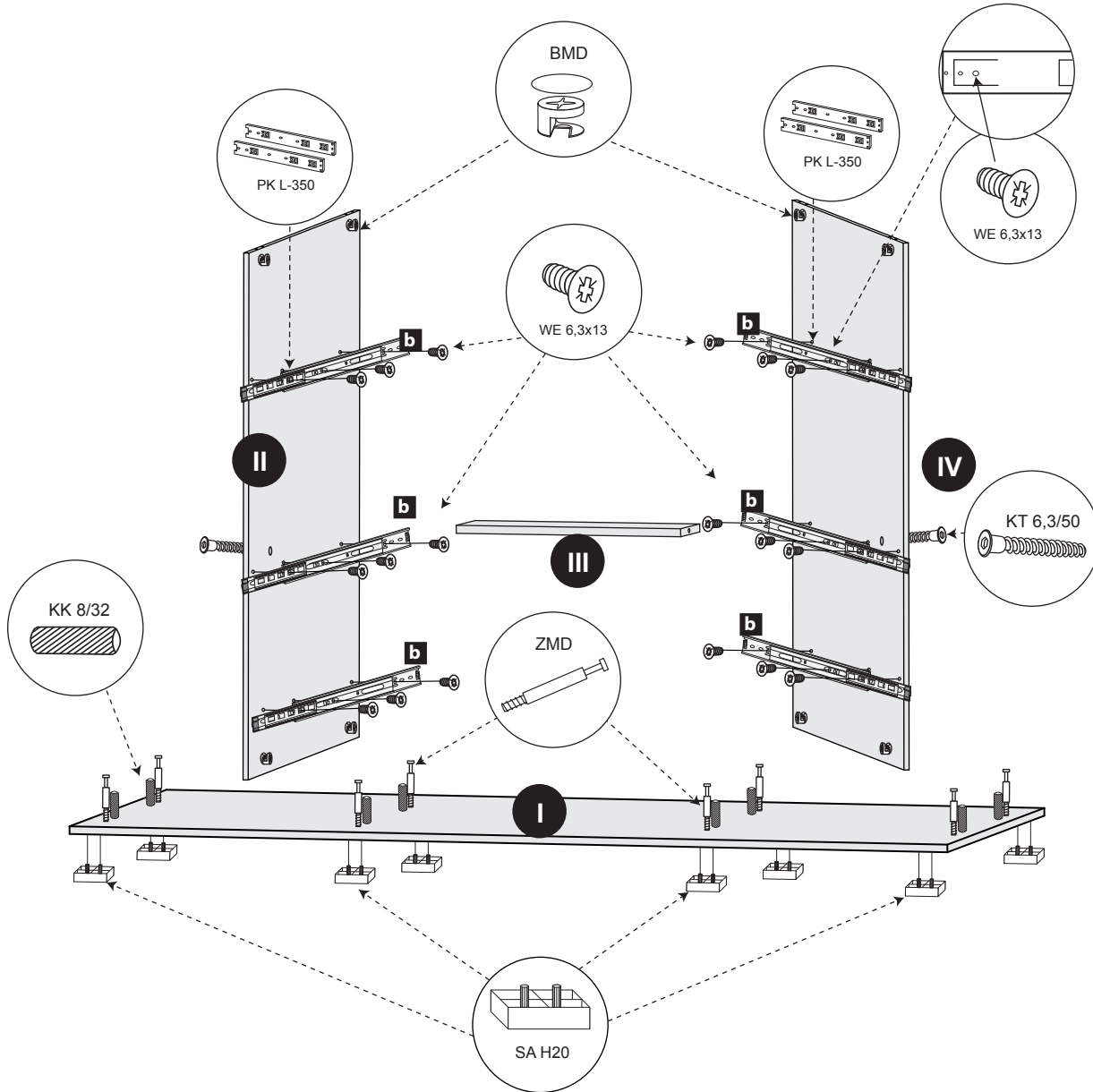
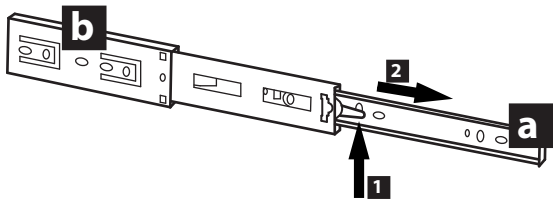

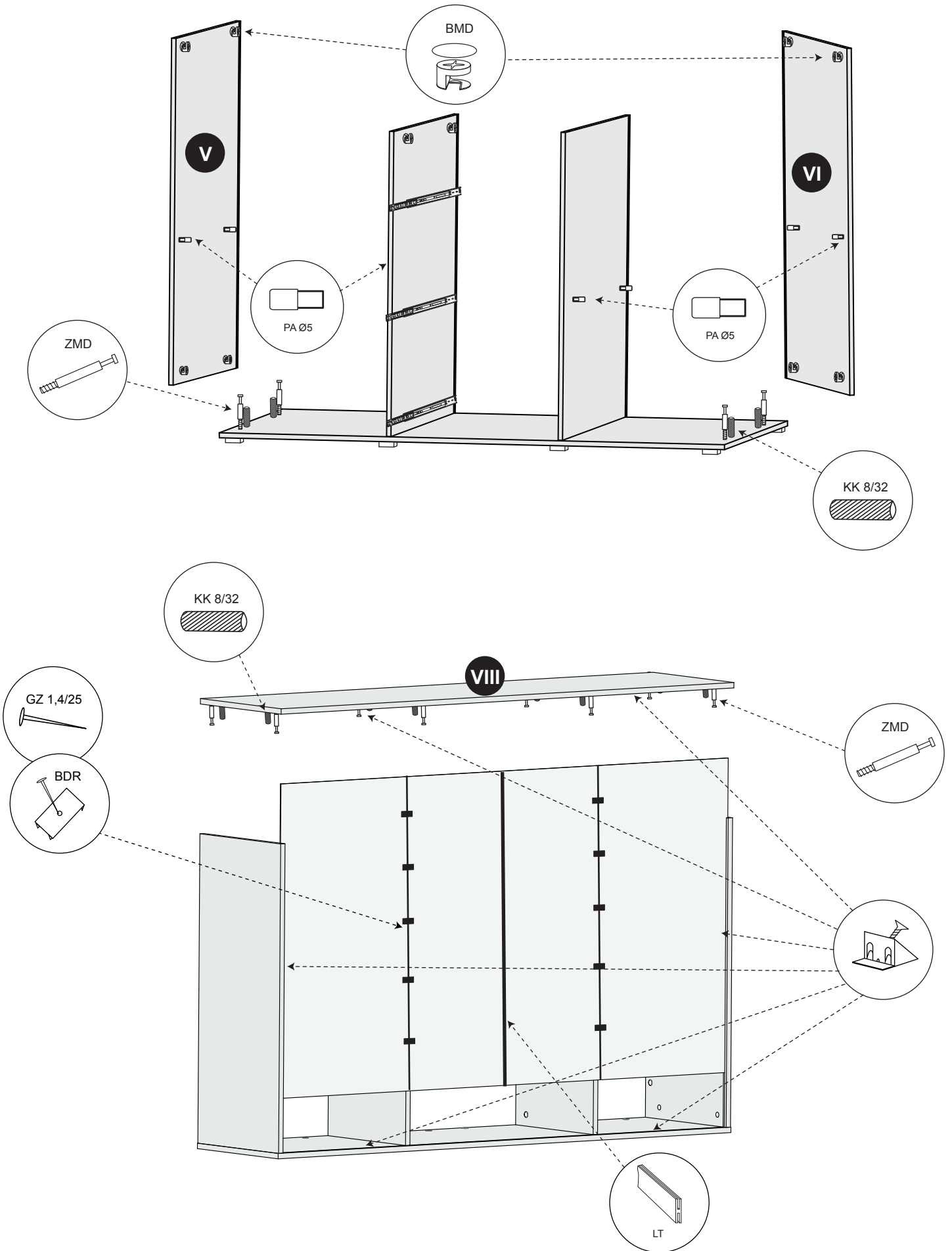
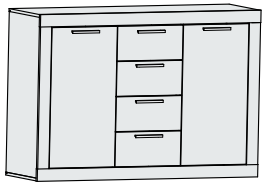

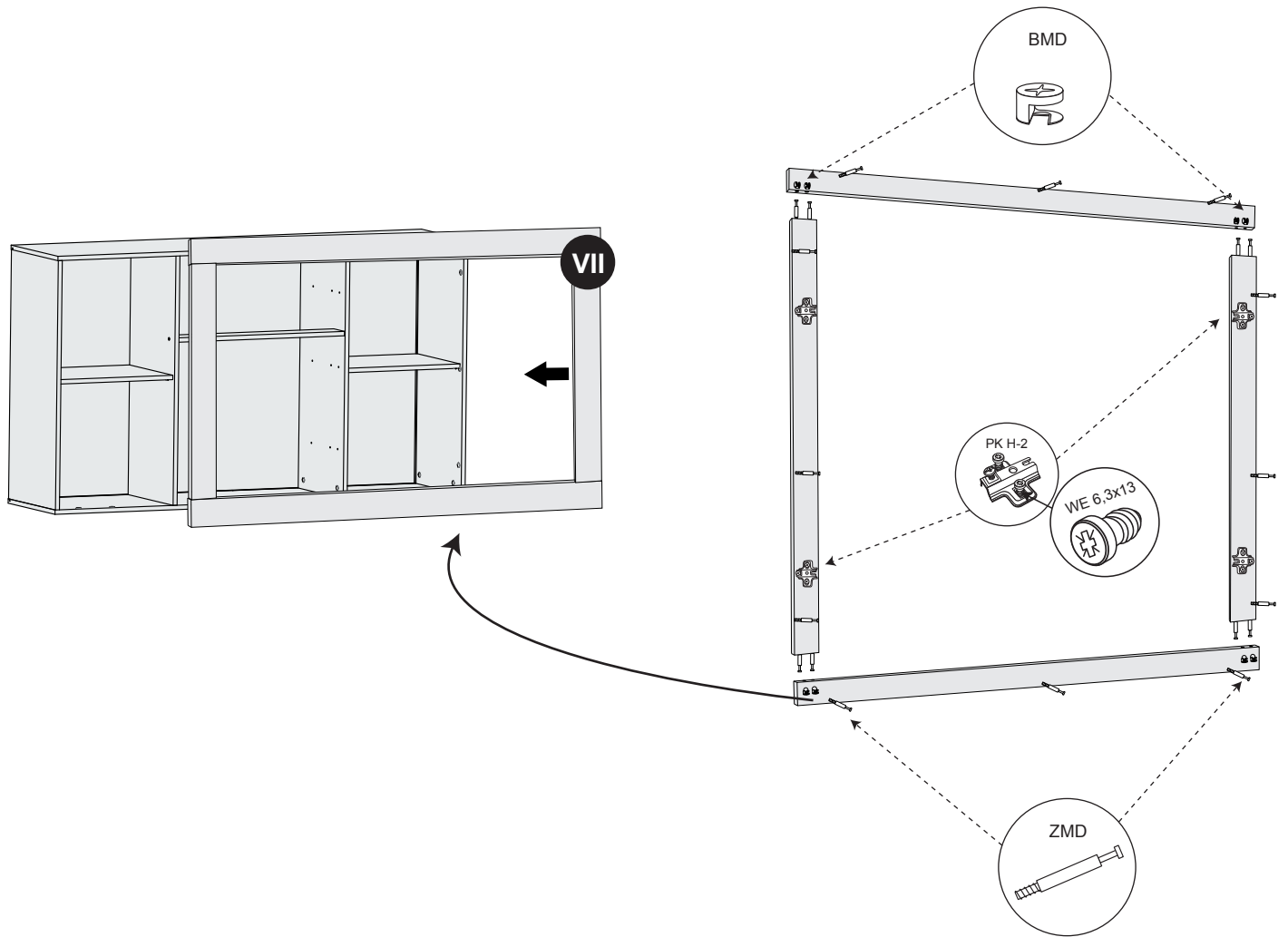
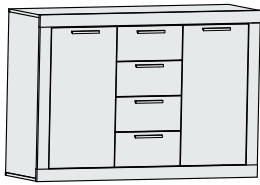

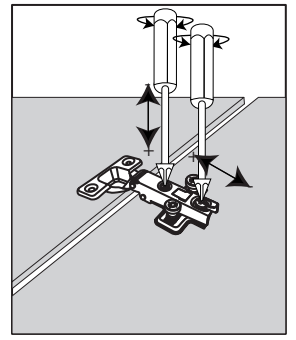
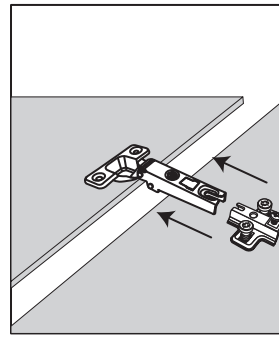
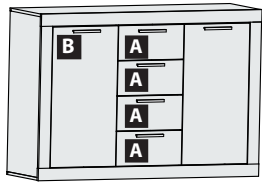

Possibility of assembling the right-left.
 Möglichkeit der Montage der rechts-links.
 Možnost montáže vpravo-vlevo.
 Возможность монтажа вправо-влево
 Galima padaryti pusę kairę arba dešinę.

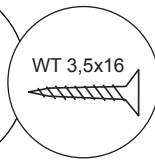
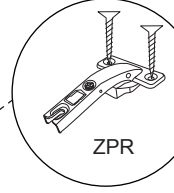
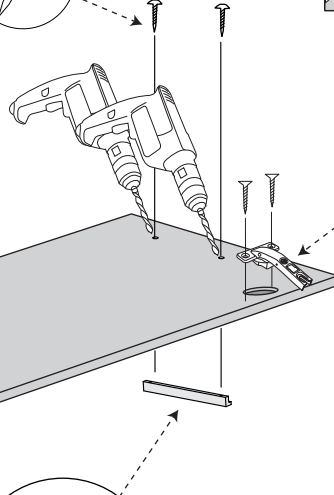

B

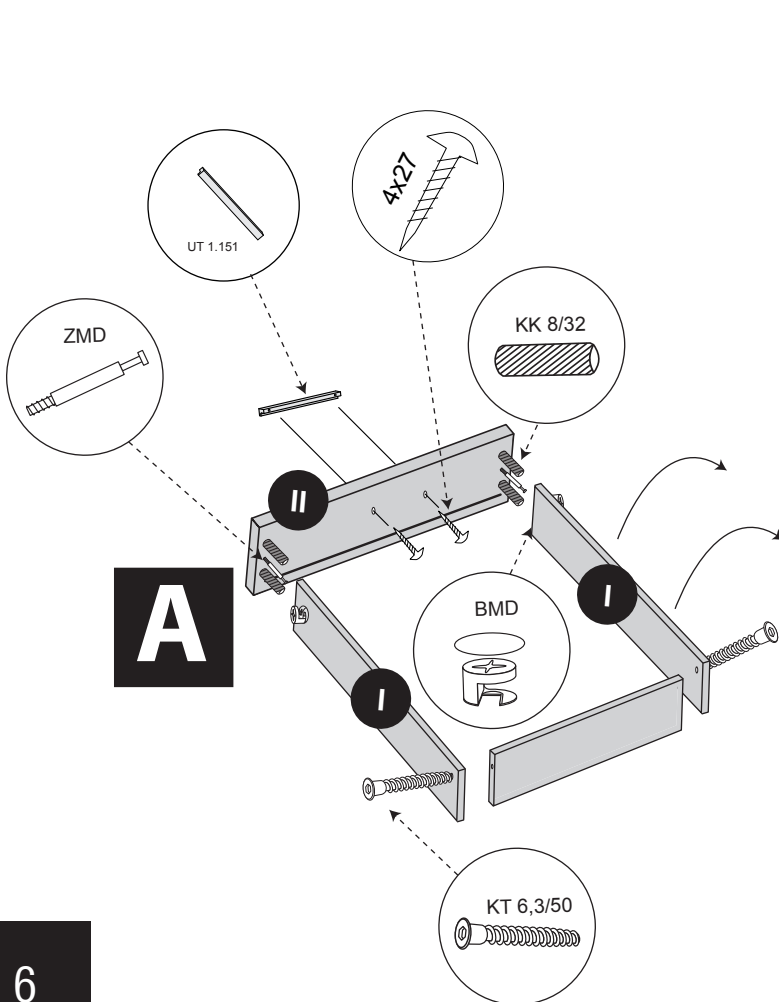
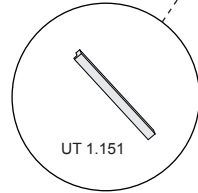

A

