

	mm	mm	mm	
9	800	660	22	1
10	800	660	22	1
11	800	430	22	1
12	946	110	22	2
13	515	110	22	2
14	734	100	22	2
15	734	100	22	2
16	734	78	22	2
17	734	78	22	2
18	669	70	16	2

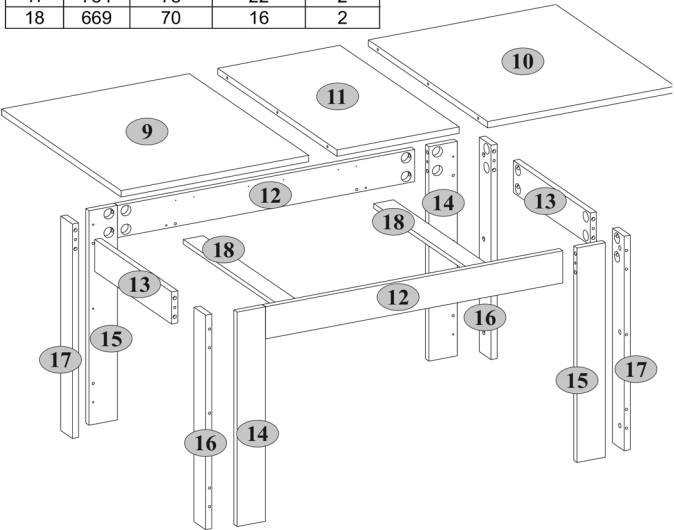
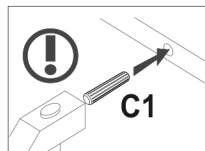
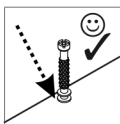
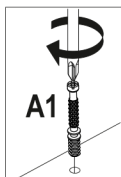
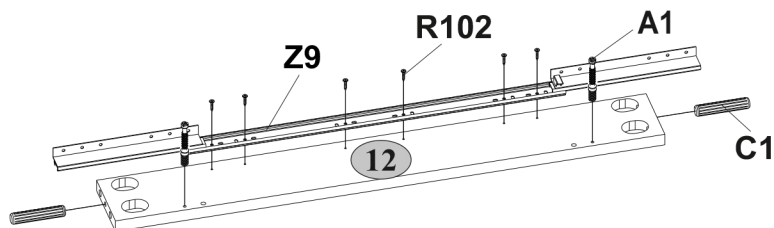
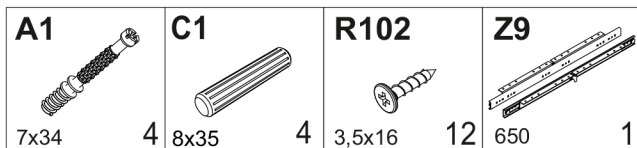
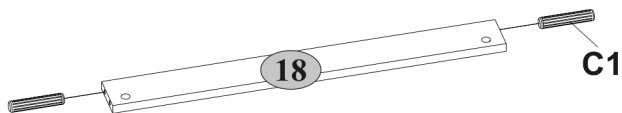
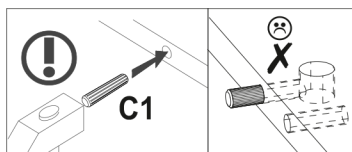
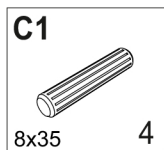

<b>A1</b>		<b>A2</b>	
7x34	16	15x12	16
<b>A4</b>		<b>C1</b>	
L-65	16	8x35	20
<b>I</b>		<b>I-2</b>	
S4	1	M6	1
<b>N1</b>		<b>R102</b>	
	8	3.5x16	28
<b>S5</b>		<b>Z9</b>	
Ø18	8	650	1

**1****x2****2****x2**

**3**

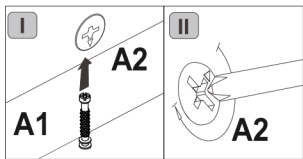
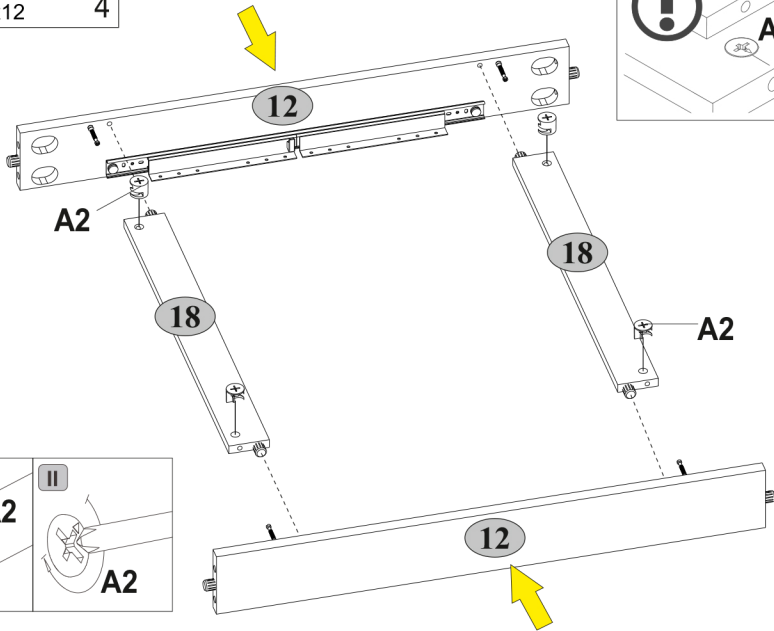
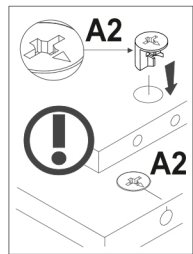
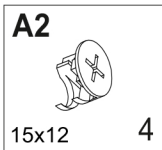

**4**

**x2**

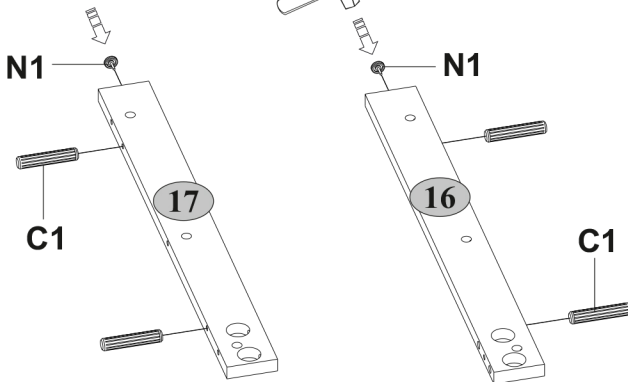
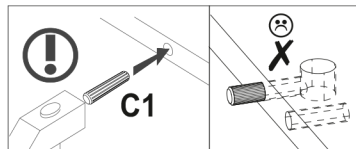
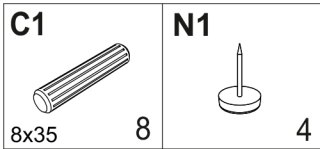

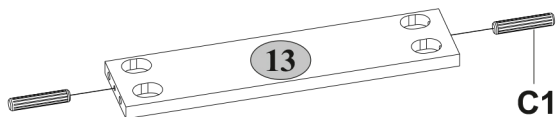
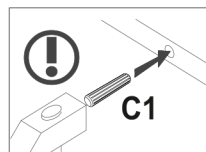
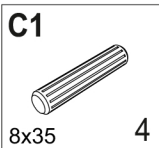
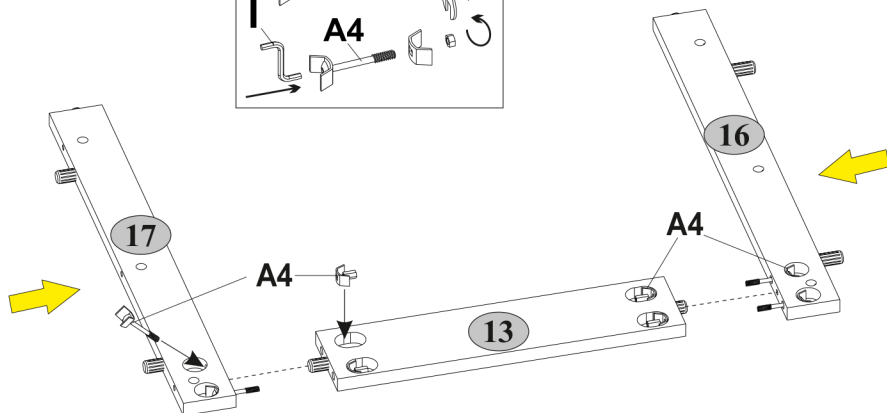
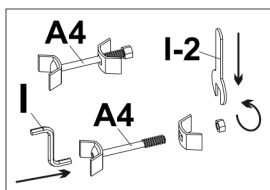
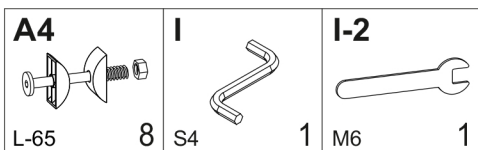
**5****x2****6****x2**

**7****x2****A1**

7x34

**N1**

12

4

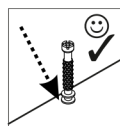
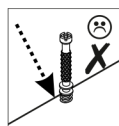
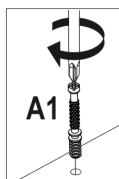
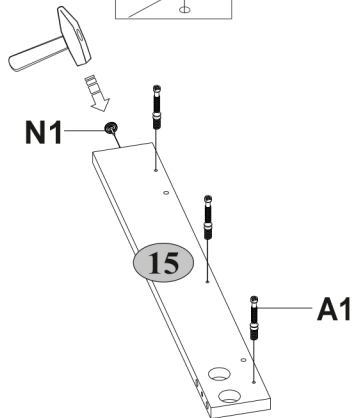
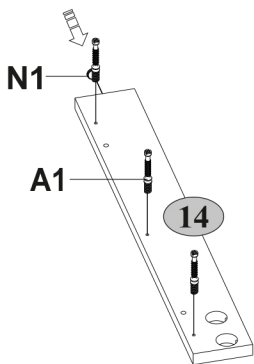
**8****x2****A2**

15x12



12

**S5**

Ø18



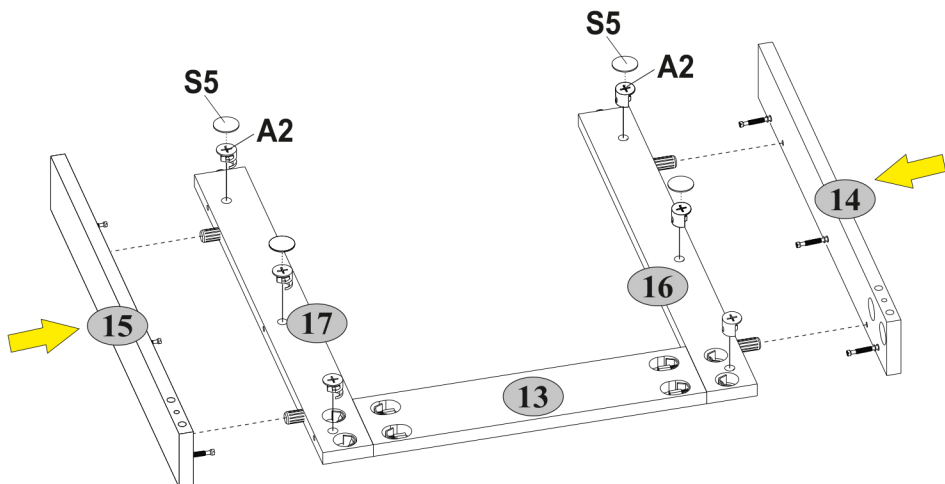
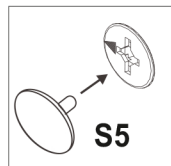
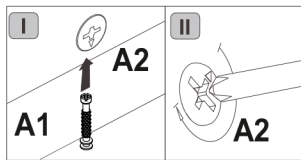

8

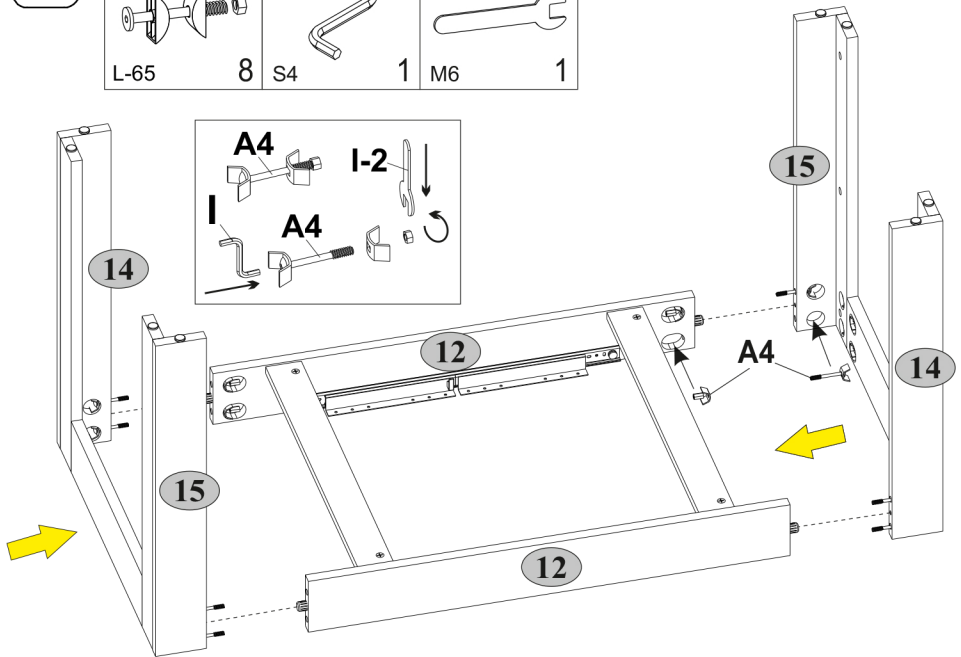
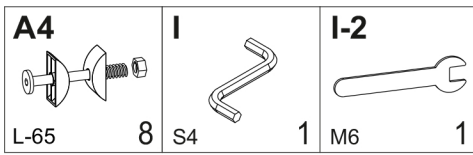
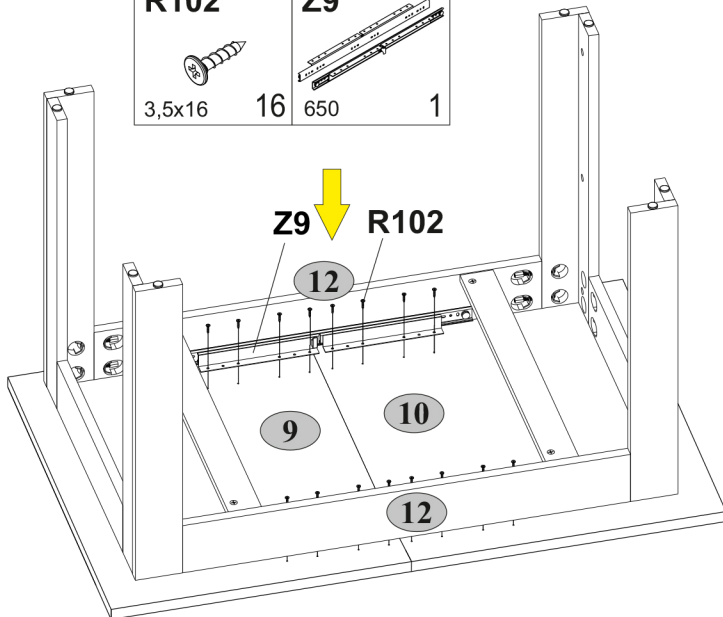
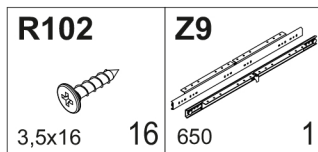

**9****10**

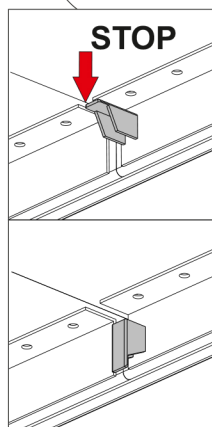
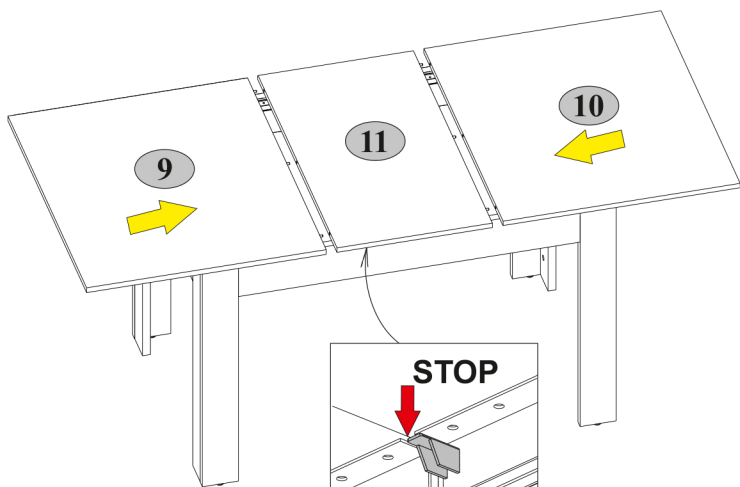
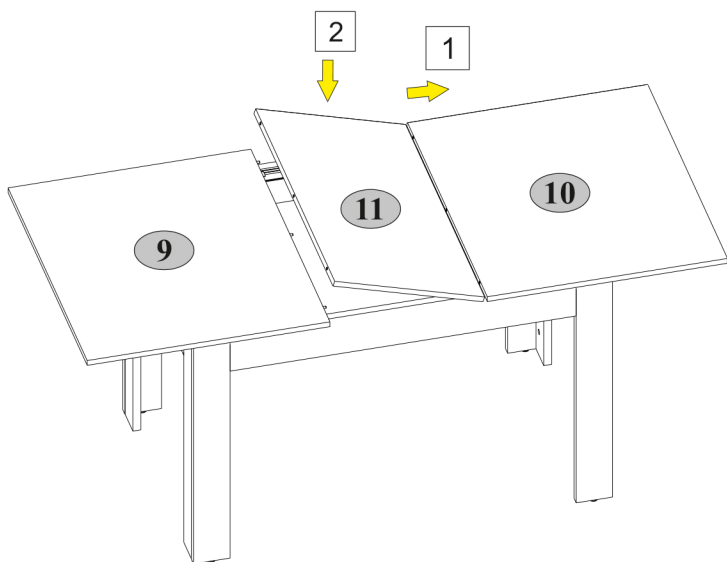
**11**



**9 + 10 + 11**  **max. 30 kg**