

<b>A1</b> 7x34 1	<b>A2</b> 28 1	<b>C1</b> 8x35 34
<b>H48</b> 1	<b>I</b> S4 1	<b>M5</b> M4x25 2
<b>N1</b> 6	<b>R3</b> 3x20 14	<b>R24</b> 7x50 8
<b>R27</b> 5.0x13 10	<b>R102</b> 3.5x16 16	<b>S1</b> 2
<b>S5</b> Ø18 4	<b>U5</b> 36x36 4	<b>V8</b> 2
<b>Z25</b> 300 1		

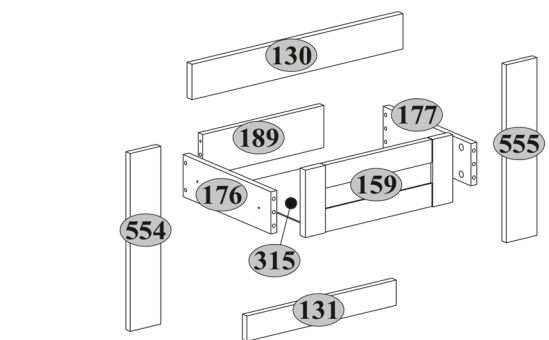

	mm	mm	mm	
8	540	382	16	1
38	540	362	16	1
52	508	362	16	1
105	380	362	16	1
106	380	362	16	1
130	578	84	18	1
131	409	60	16	1
153	149	362	16	1
154	149	362	16	1
159	404	160	19	1
176	320	100	16	1
177	320	100	16	1
189	332	100	16	1
261	506	382	18	1
262	506	382	18	1
296	400	534	2.5	1
315	362	325	2.5	1
554	422	84	18	1
555	422	84	18	1

1

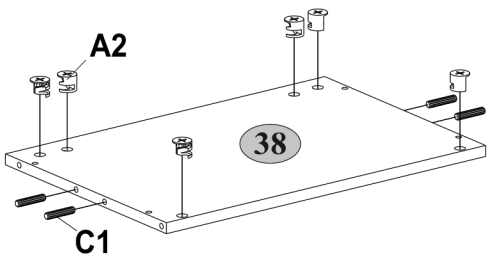
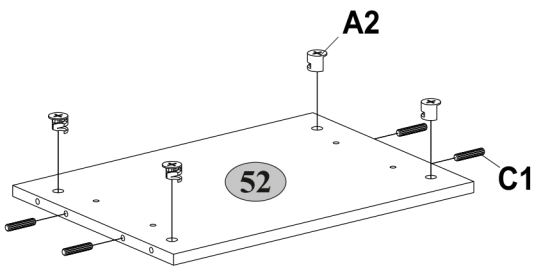
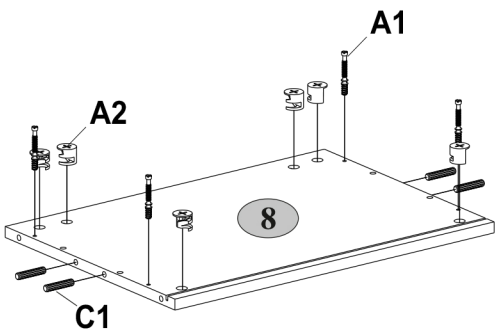
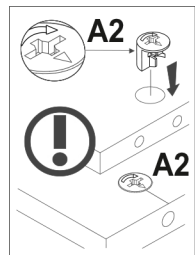
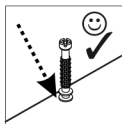
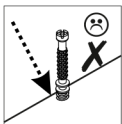
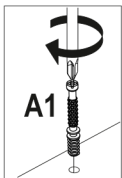
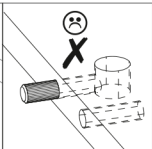
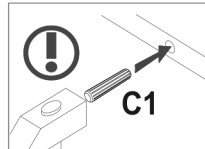
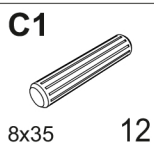
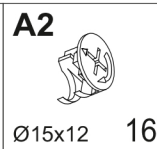
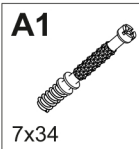

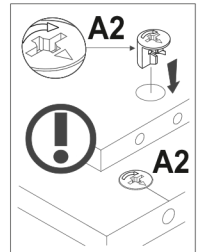
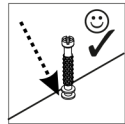
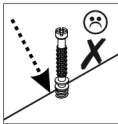
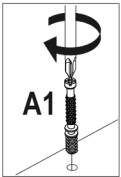
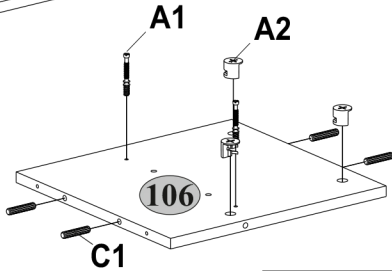
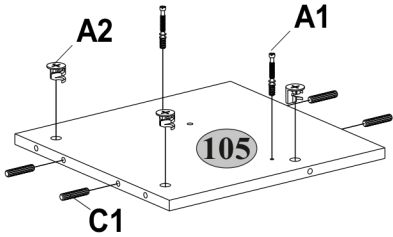
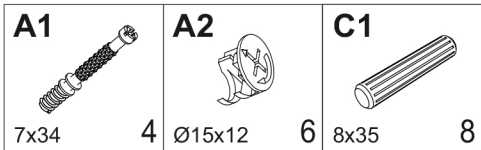

**2**

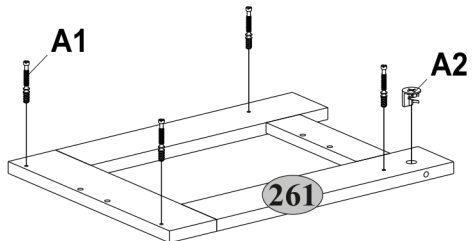
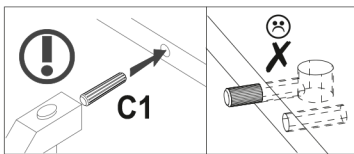
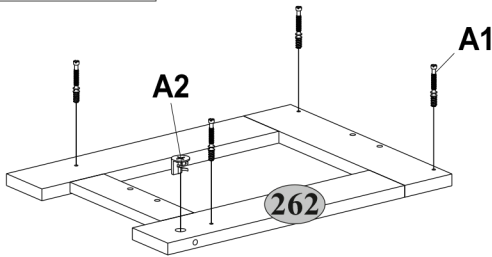
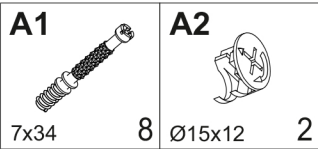

**3**

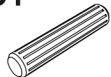

**4**

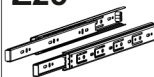
<b>C1</b>  8x35	<b>R27</b>  5,0x13	<b>Z25</b>  6 300 1
---	--	---

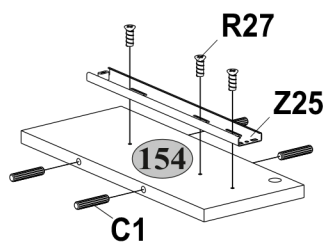
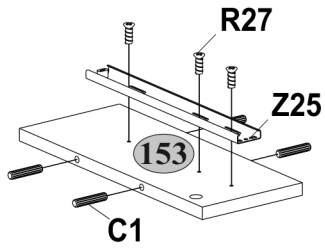
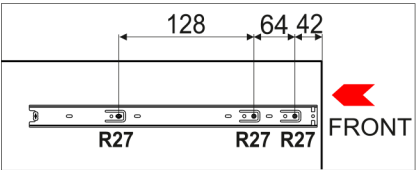
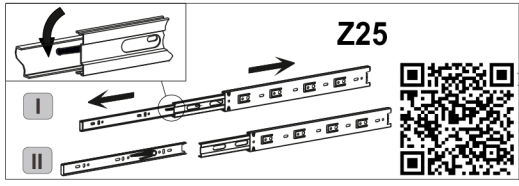

**5**

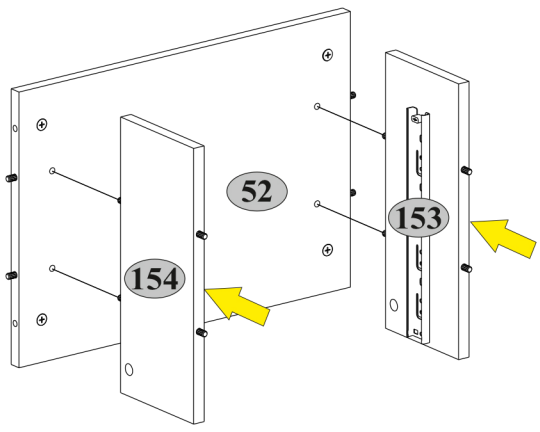



6

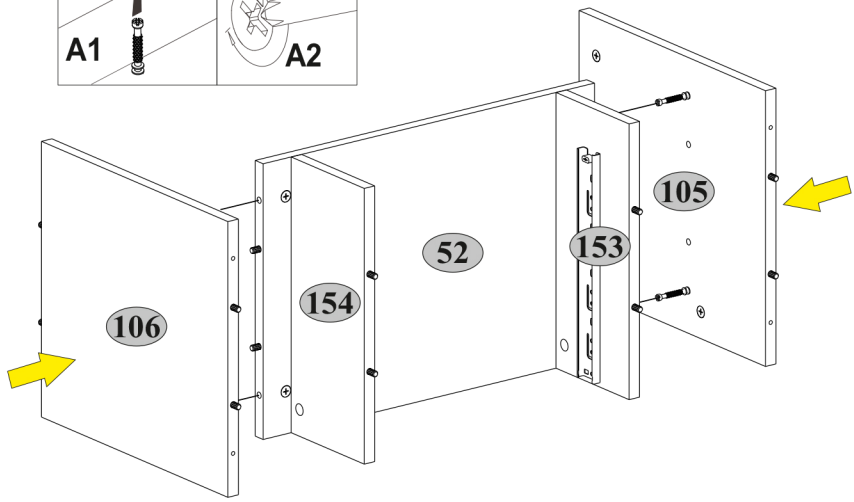
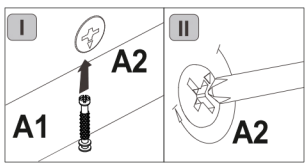

7

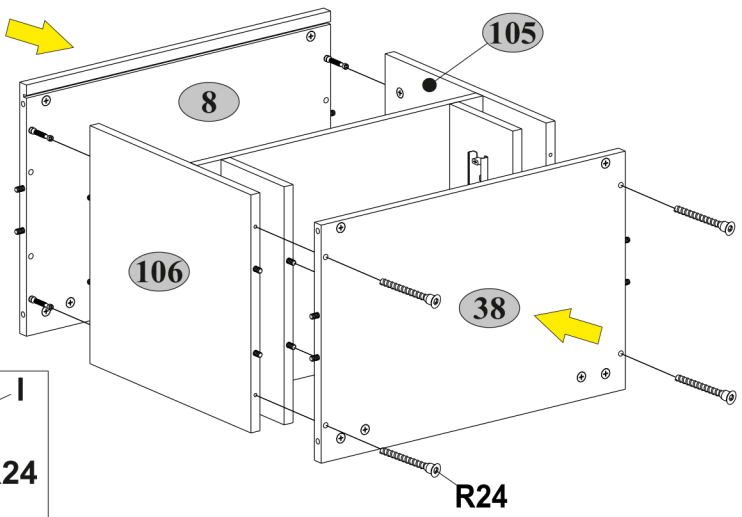
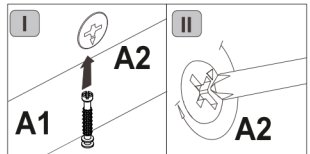
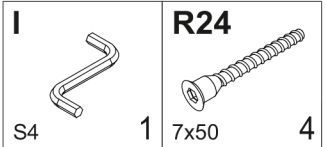

**8****R3**

3x20

**S1**

2

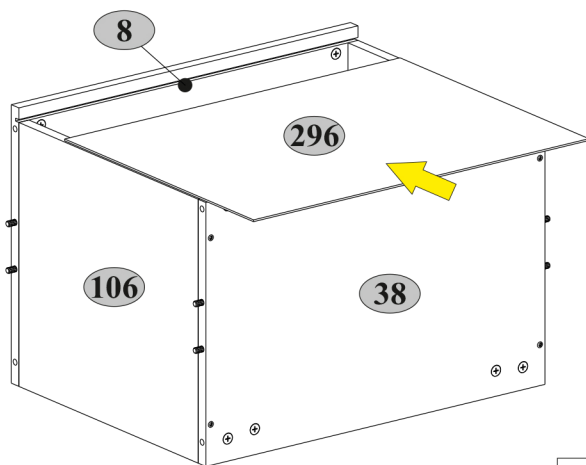
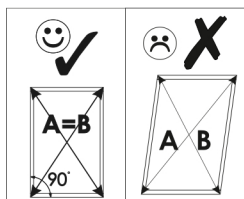
**I****II**

A=B

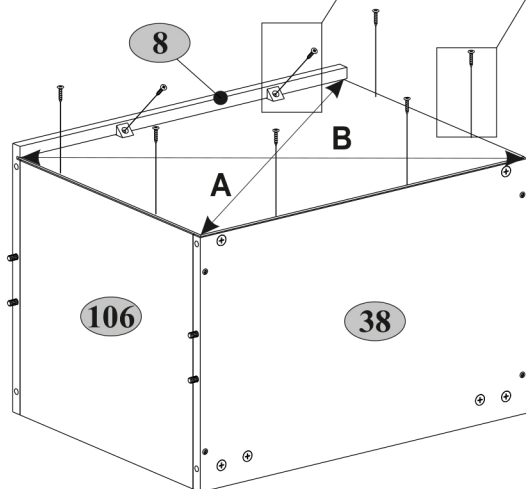
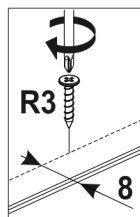
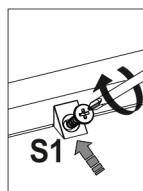
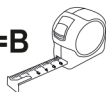

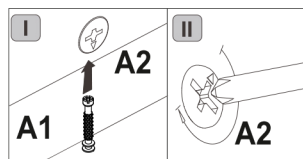
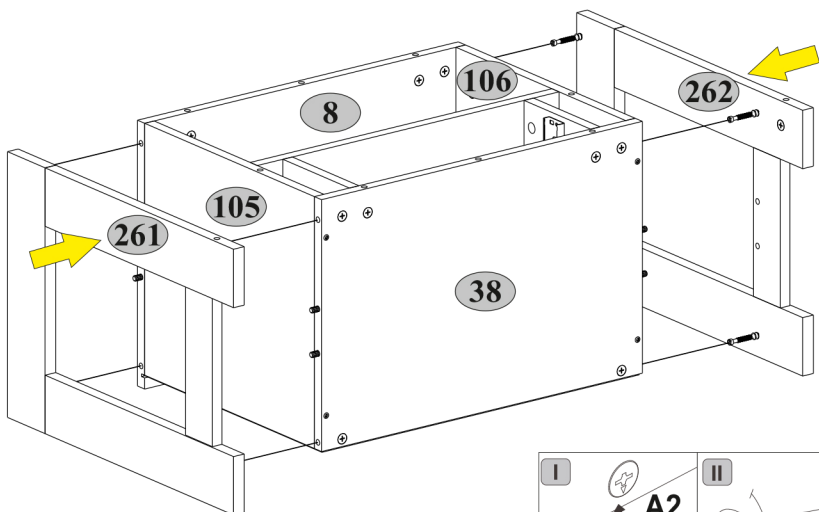

180°

9





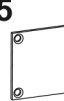

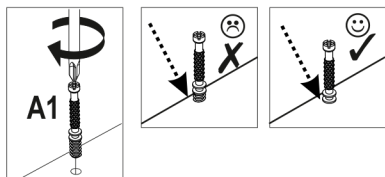
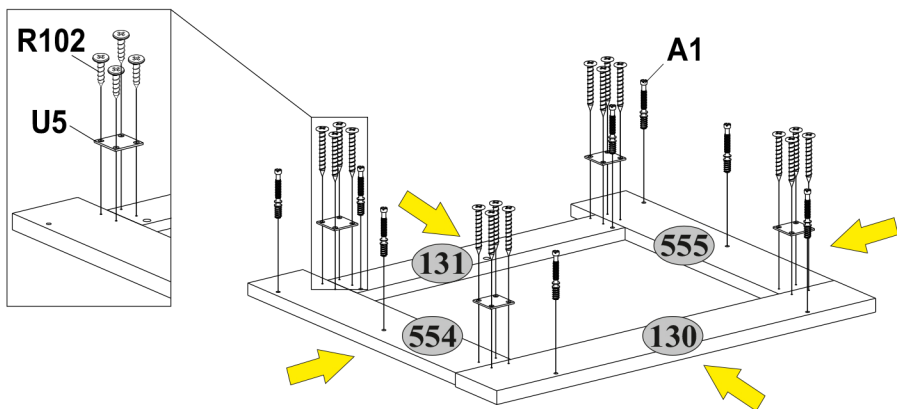

10

<b>A1</b>  7x34	<b>R102</b>  3,5x16	<b>U5</b>  36x36
8	16	4

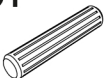
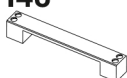

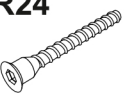
**11**

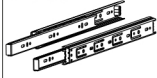
<b>A1</b>  7x34 4	<b>A2</b>  Ø15x12 4	<b>C1</b>  8x35 4	<b>H48</b>  1	<b>I</b>  S4 1
<b>M5</b>  M4x25 2	<b>R24</b>  7x50 4	<b>R27</b>  5,0x13 4	<b>Z25</b>  300 1	

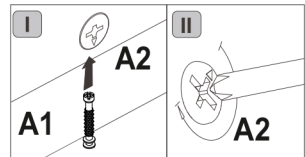
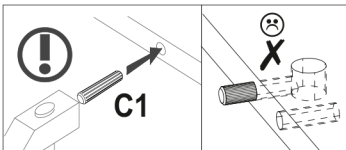
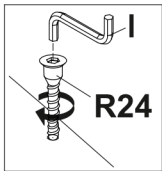
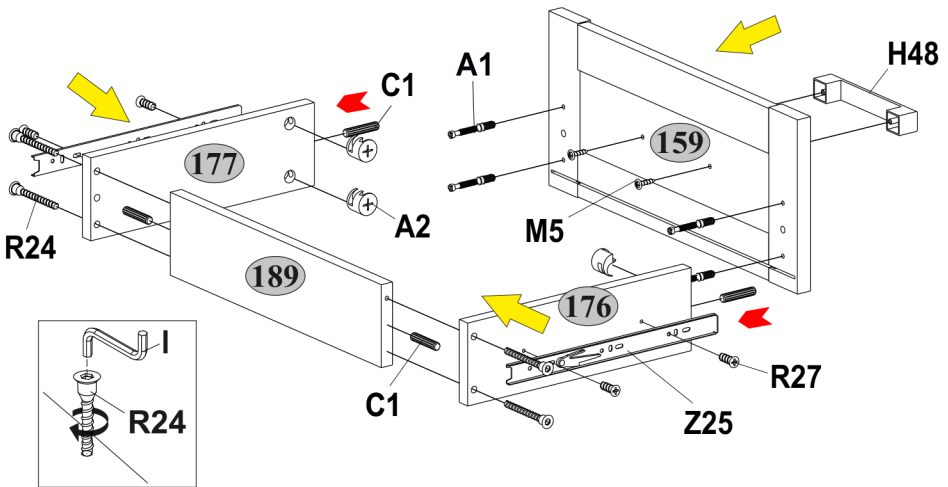
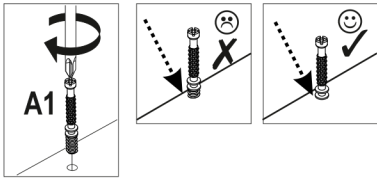
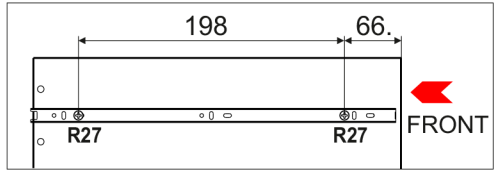
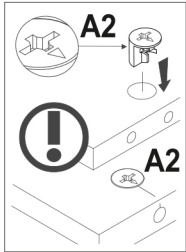

**12****R3**

3x20

8

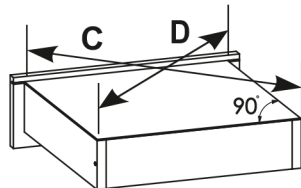
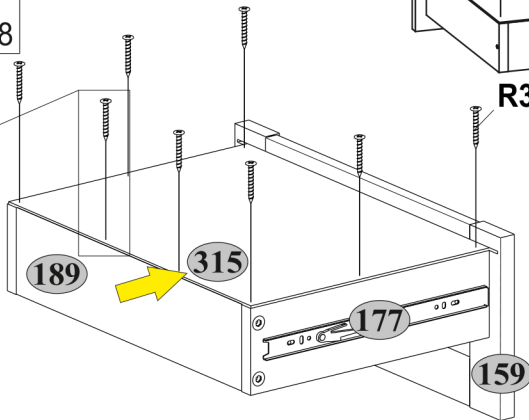
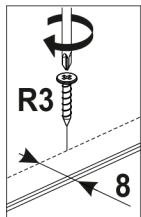
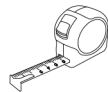
**R3****C=D****13****C1**

8x35

2

**N1**

6

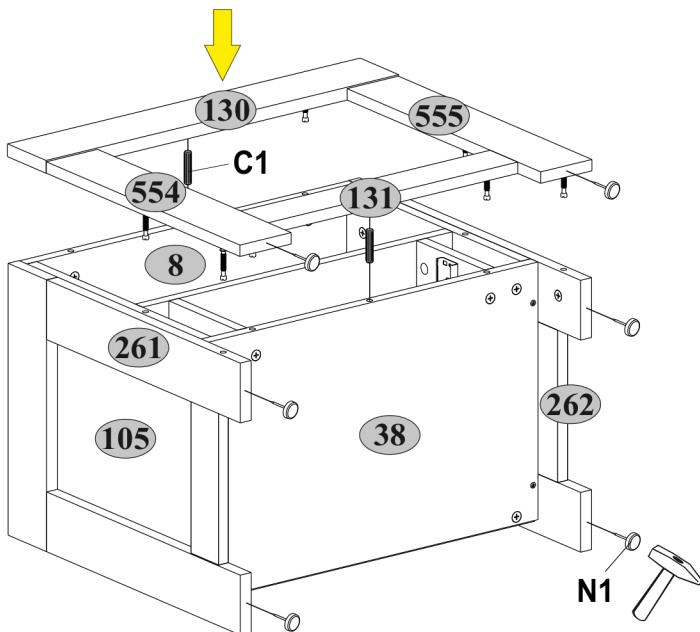
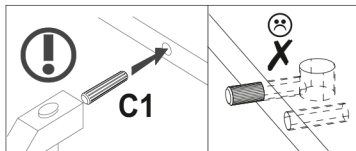
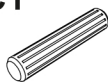

**14**

**S5**



Ø18

4

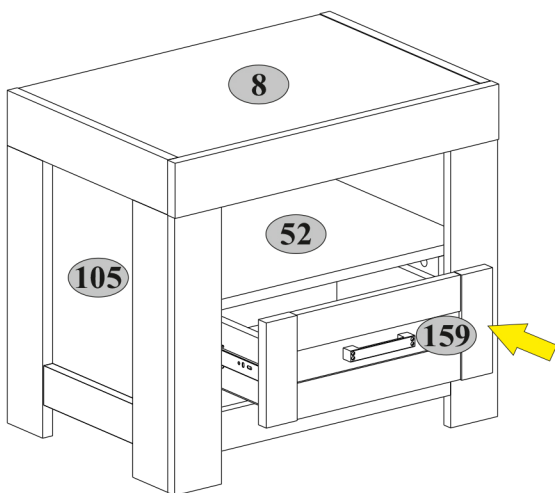
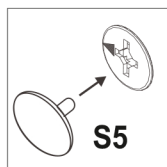

**8** **52** **159**  max. 5 kg

15

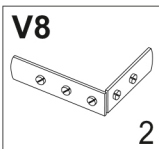

1



2



!



3

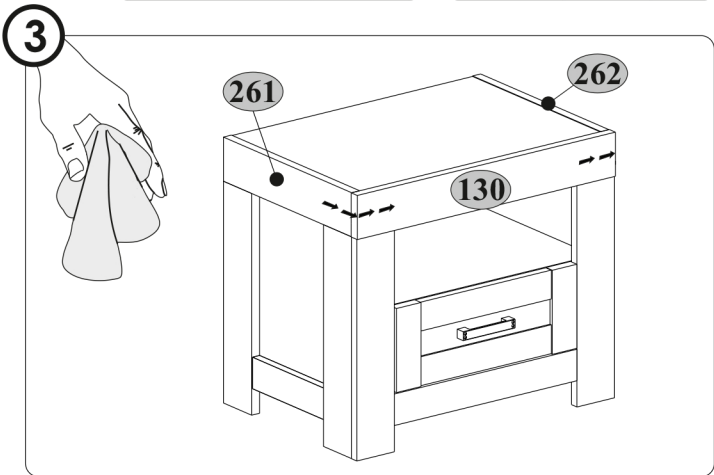

4

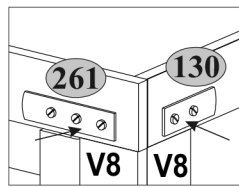
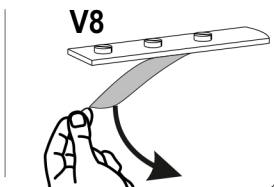
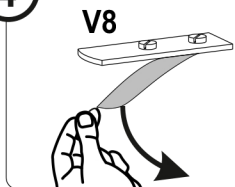

5

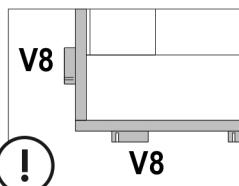
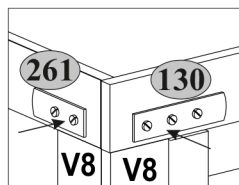

!

