

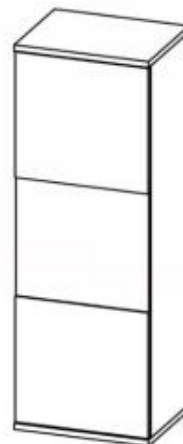

PL> INSTRUKCJA MONTAŻU  
D >MONTAGEANLEITUNG  
GB>ASSEMBLY INSTRUCTIONS

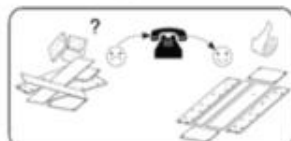
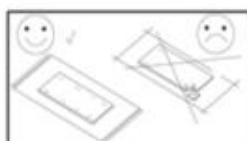
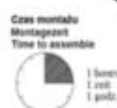

## Uwaga / Achtung / Caution

**PL>** Czyszczenie należy wykonać wyłącznie za pomocą ściereczki lub lekko nawilżonego ręcznika.  
Nie stosować środków czyszczących do szorowania.

Szanowny kliencie, jeśli podczas montażu stwierdzisz uszkodzenie lub brak części, proszę podaj jej kod alfanumeryczny lub zaznacz ją na instrukcji montażu i prześlij wraz z protokołem reklamacyjnym













**D >**Bitte nur mit einem Staubtuch oder leicht feuchtem Lappen reinigen. Keine scheuerenden Putzmittel verwenden.

Sehr geehrter Kunde, sollte ein Teil fehlen oder beschädigt sein, kreuzen Sie dies bitte deutlich auf der Montageanleitung an und schicken Sie die Montageanleitung mit ein.

**GB>**Please only clean with a duster or a damp cloth. Do not use any abrasive cleaners.

Dear customer, should there be any piece missing or damaged, kindly mark this piece clearly on the attached assembly instructions and return them to us.

## Karta serwisowa /Service Karte /Service card

8.0x30  D 16	 A 16	Ø15x12  B 16	 X 16	 ZA 2	4.0x30  G1 4	3.0x16  H4 2	 I 6
 L 4	"0"  Z 4	 KR 2	 ODB 1				

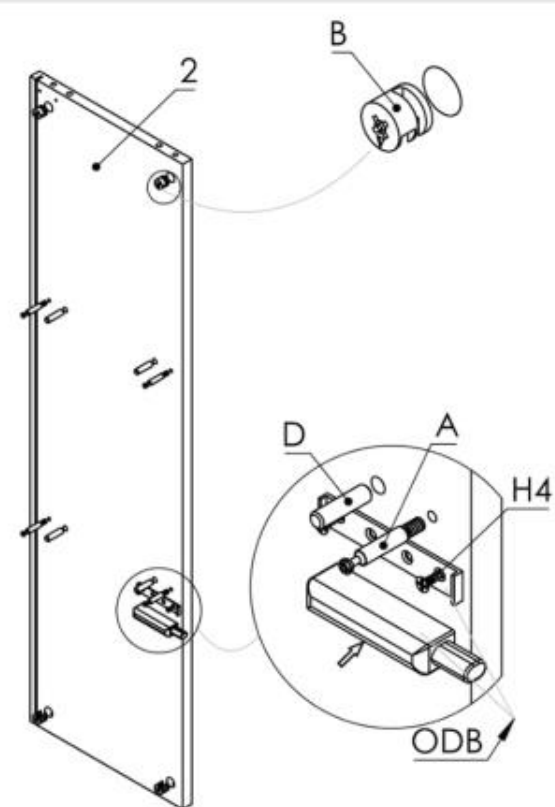
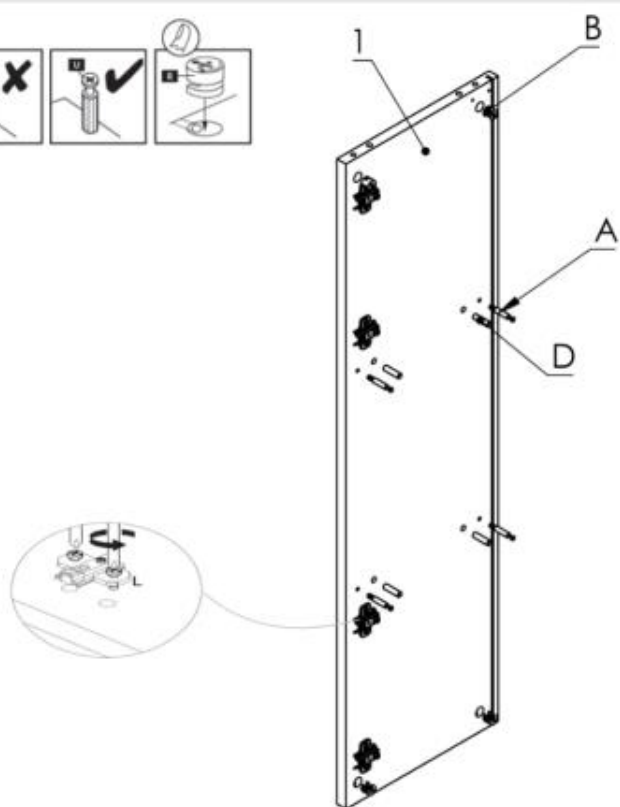
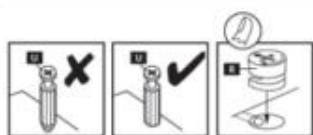
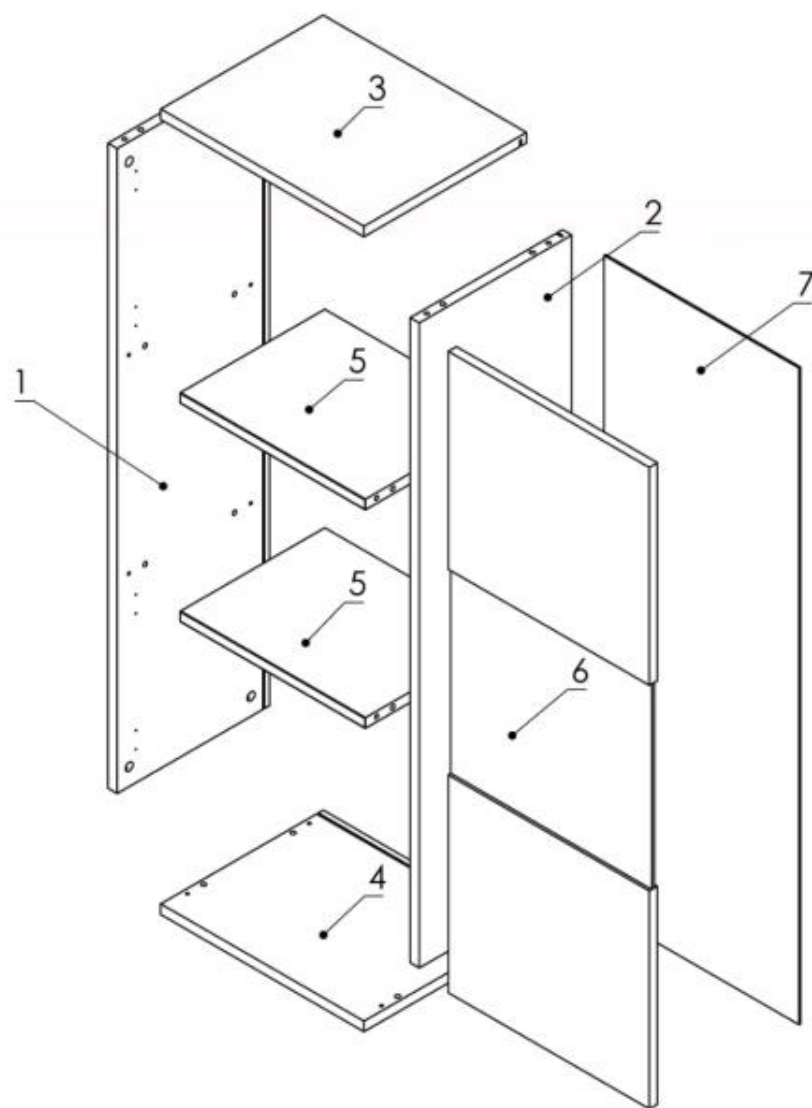

3 / 4

