

# MIRROR

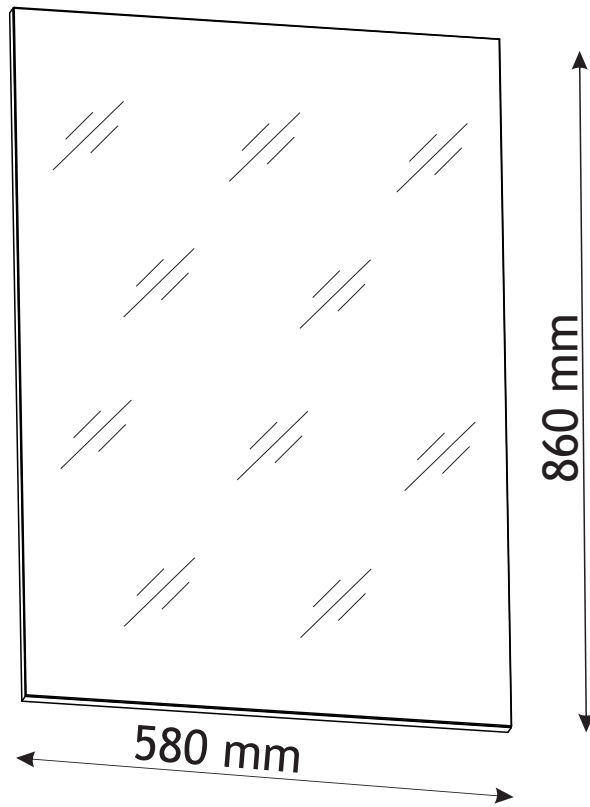

**A**

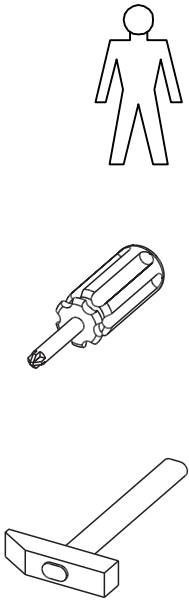
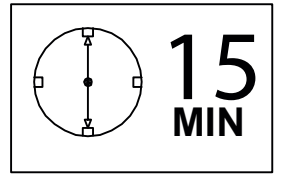
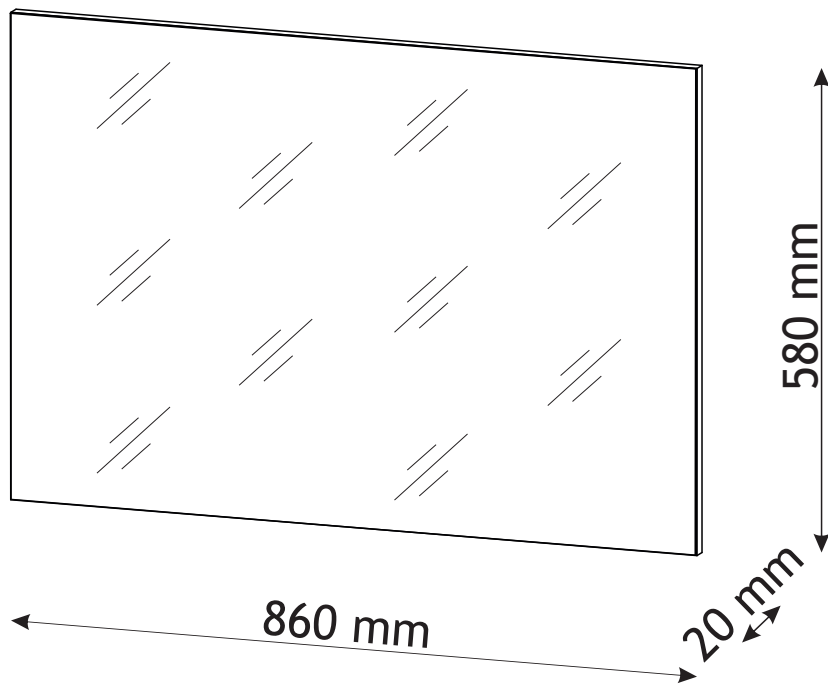
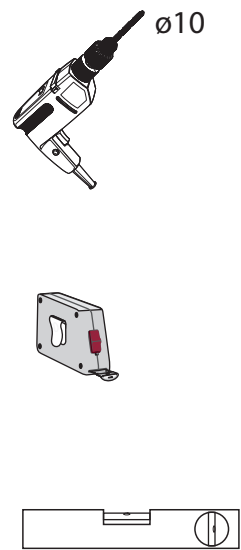

**B**

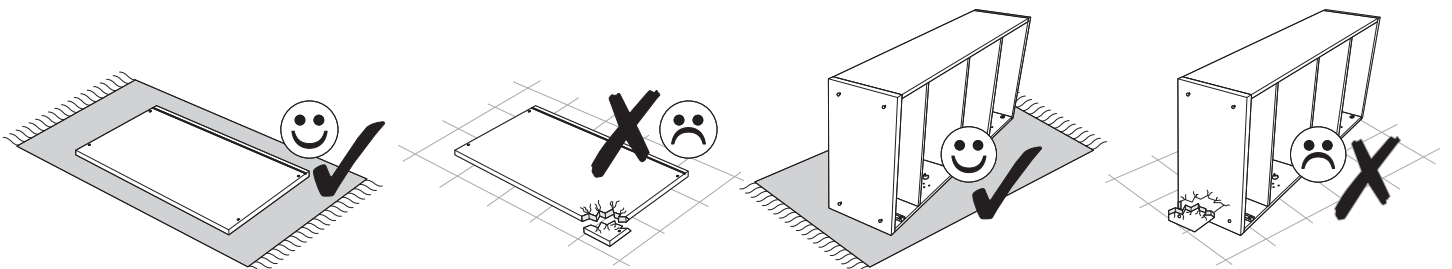

# MIRROR

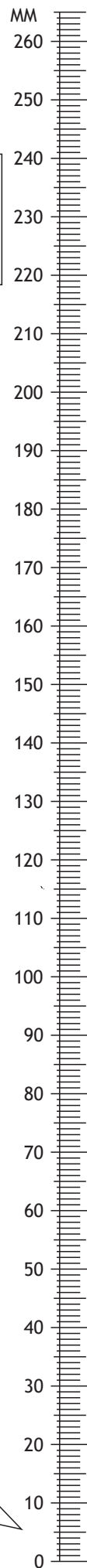

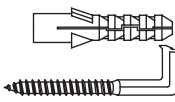
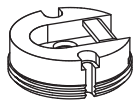

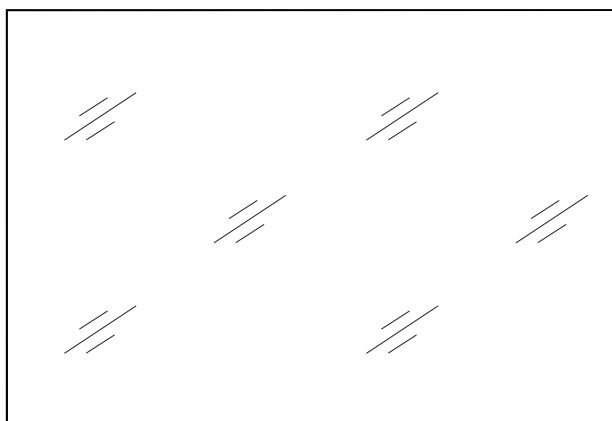
<b>D22</b> 5 x 11 mm  <b>x4</b>	<b>E1</b> 10x 50 mm  <b>x2</b>	<b>P1</b>  <b>x2</b>
--	---	--

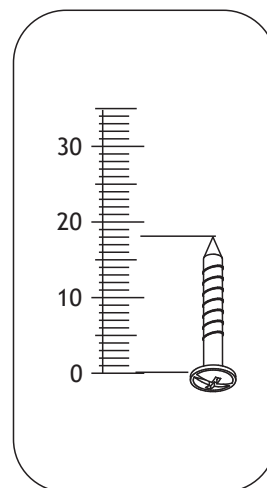
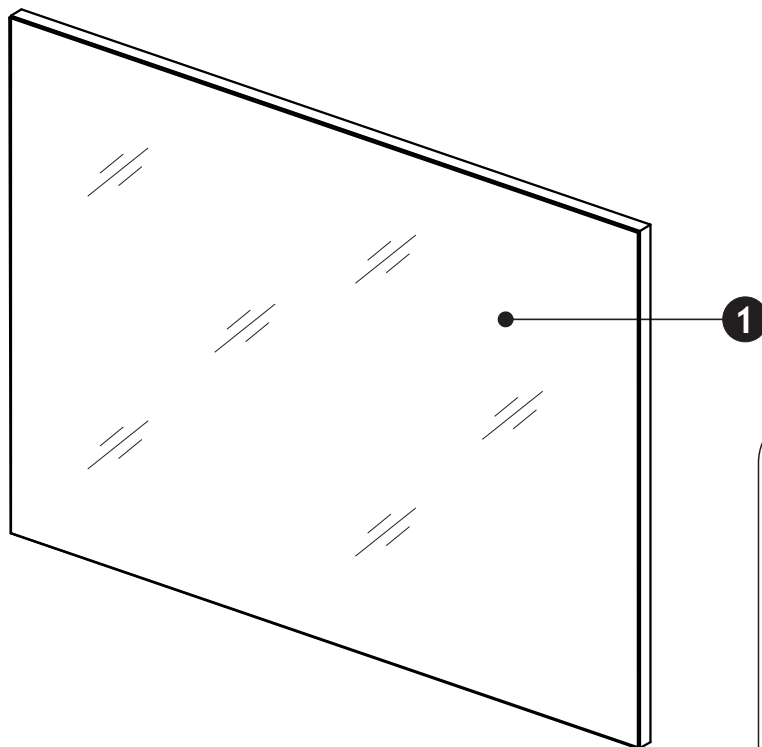

<b>1</b> 	860	580	20	x1	1/1
					1/1



# 1 ▶

<b>D22</b> 5 x 11 mm 	<b>x4</b>	<b>P1</b> 	<b>x2</b>
--	-----------	--	-----------

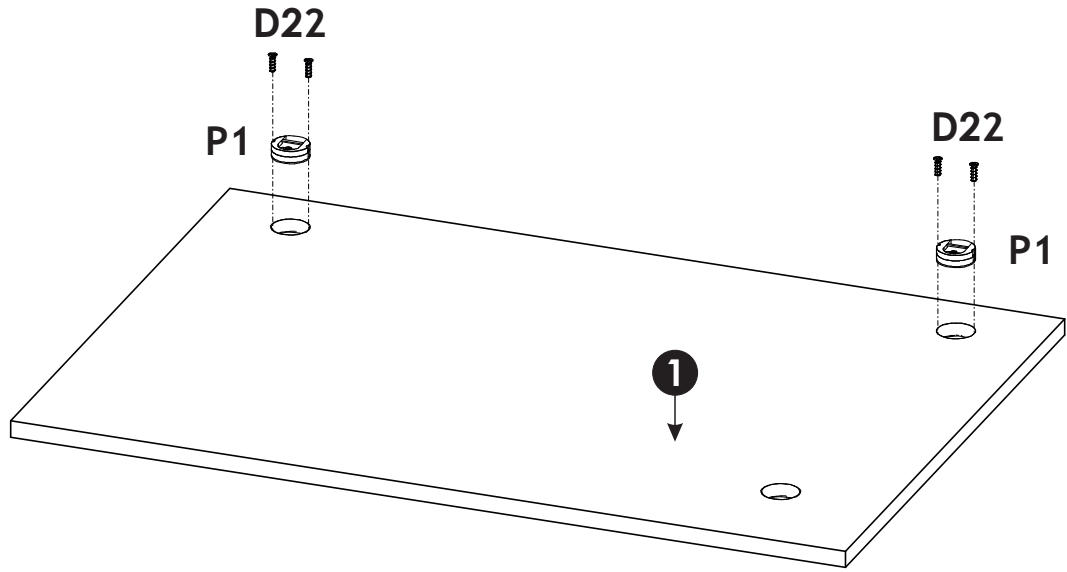
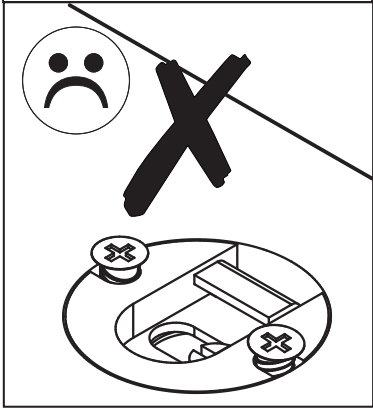
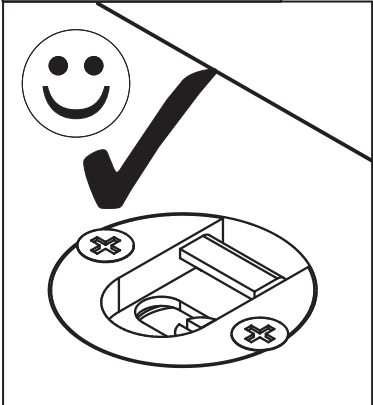
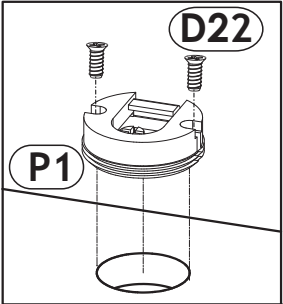

**A**

**B**

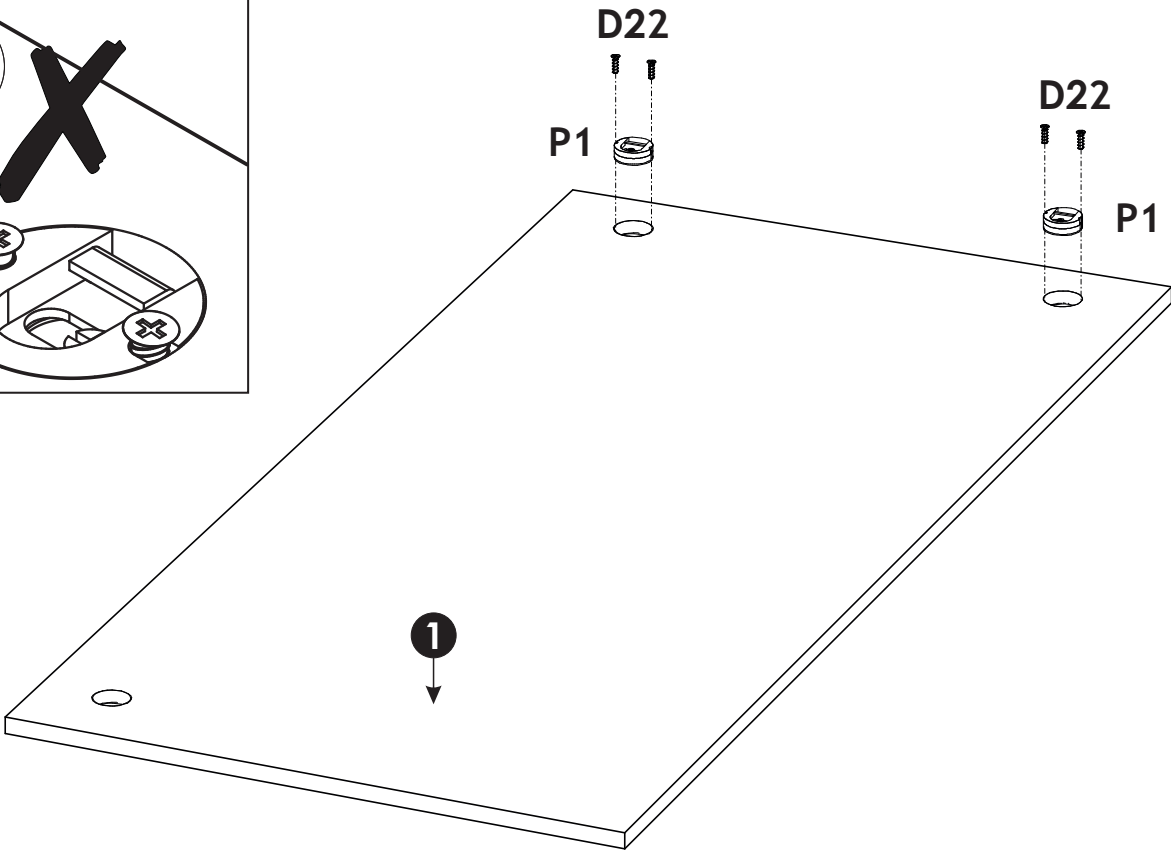

2 ▶

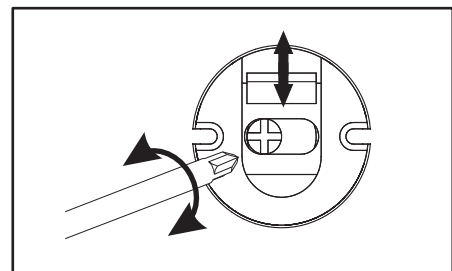
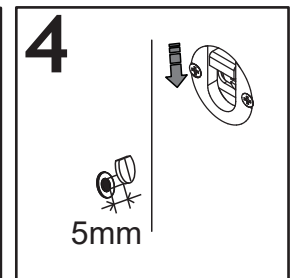
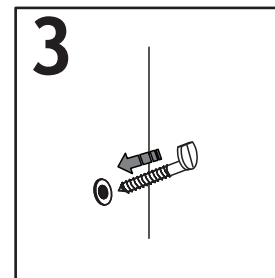
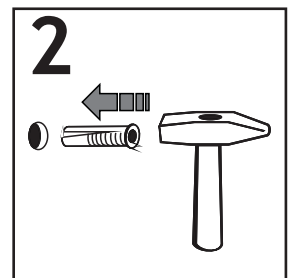
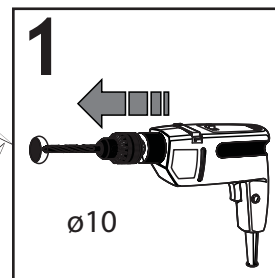
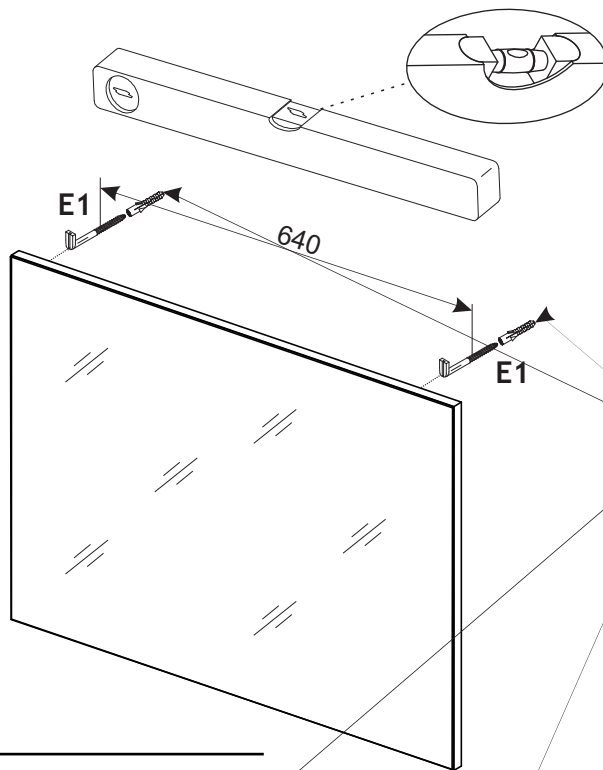
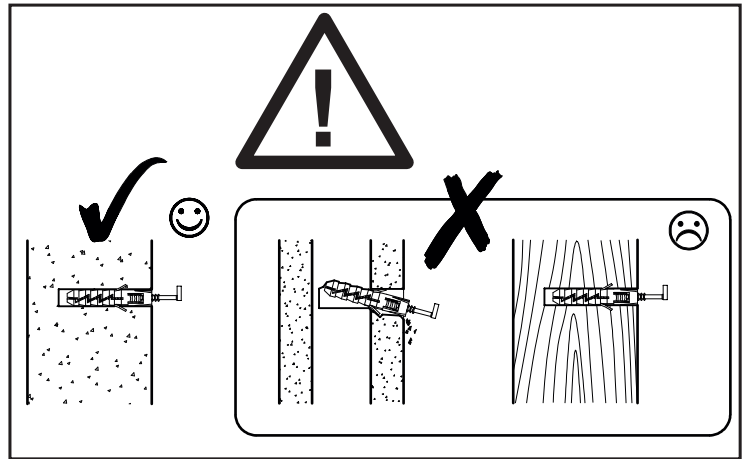
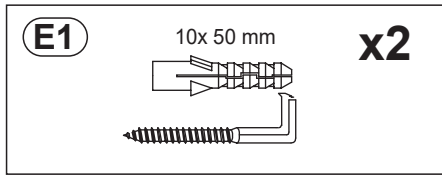

**A**

**B**