

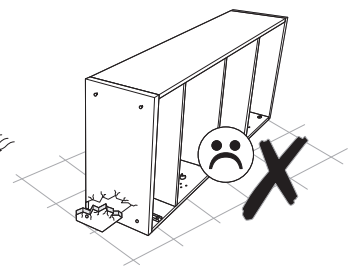

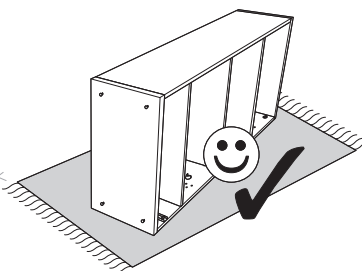

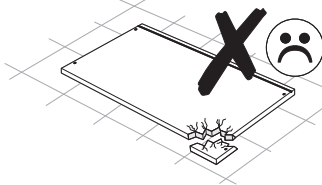

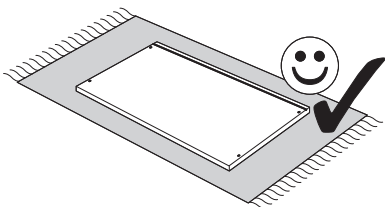

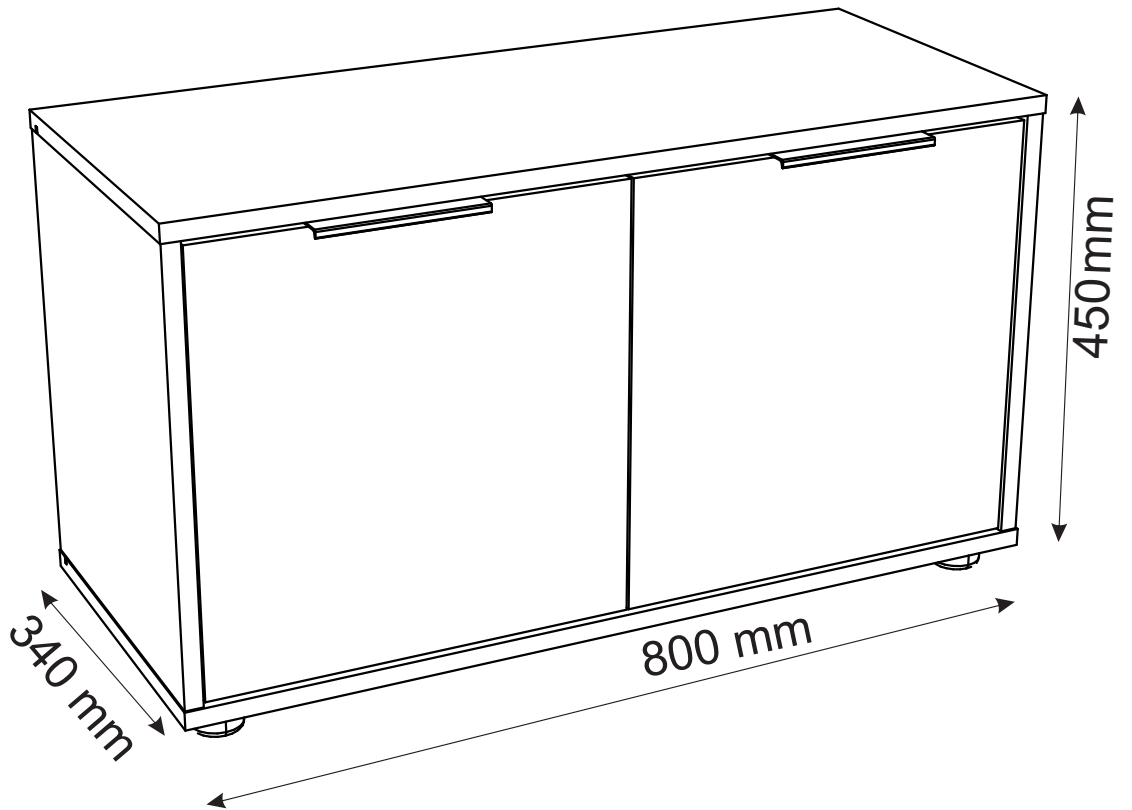
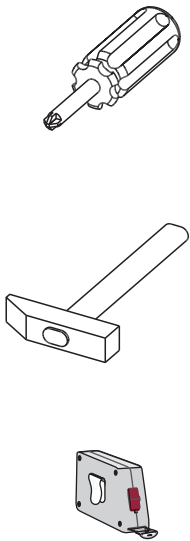
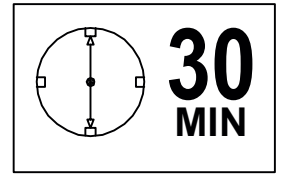
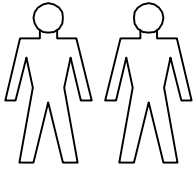
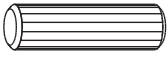

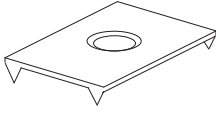
Shoe cabinet 2D

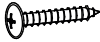
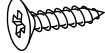

Shoe cabinet 2D

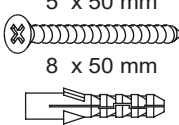
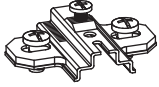
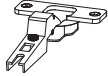
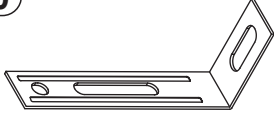
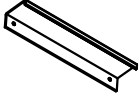
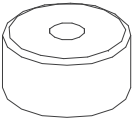
MM

A0/1 8 x 30mm  x12	D36 3.5 x 16 mm  x4	M3  x2
C0  x12	C2  x12	C7 16mm  x12
D0 3 x 15 mm  x14	D8 3.5 x 13 mm  x4	D10 4 x 16 mm  x8
D12 4 x 25 mm  x5	M1  x12	E0 5 x 50 mm 8 x 50 mm  x2
J6  x4	J4  x4	P0  x2
L43  x2	T17  x5	Q0  x8

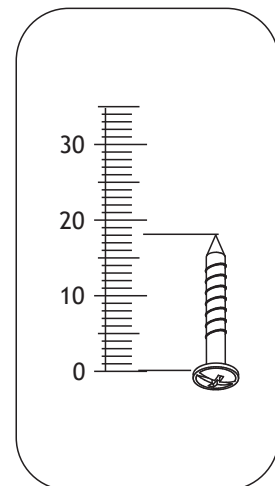

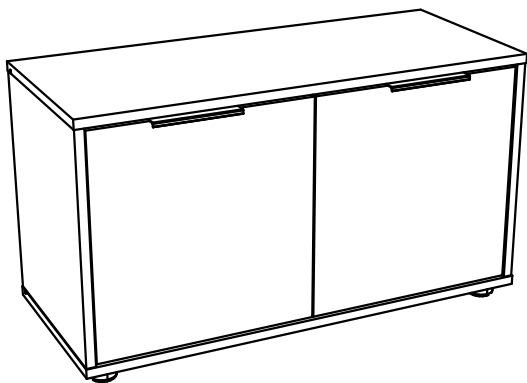
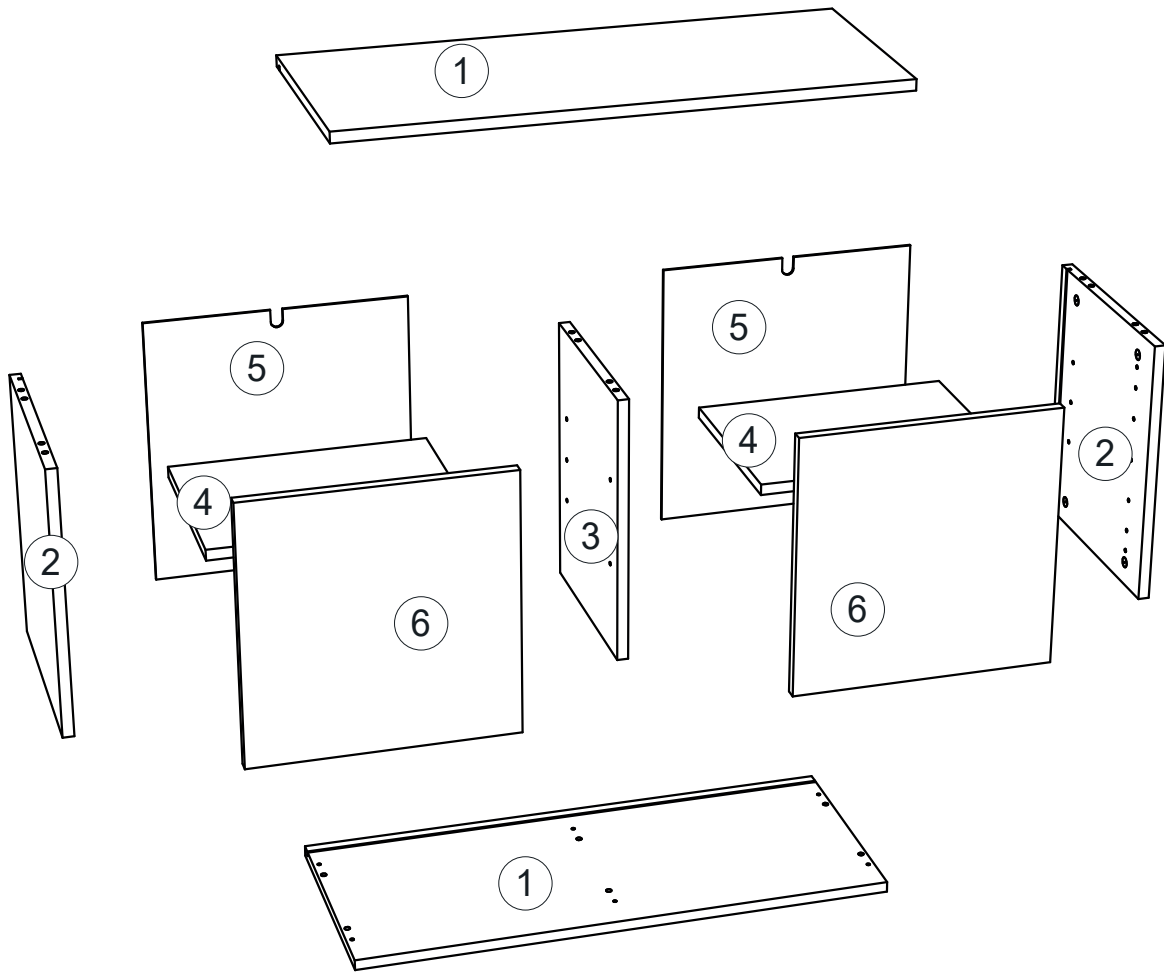

Shoe cabinet 2D



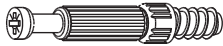

①	800	340	16	x2	1/1
②	394	338	16	x2	1/1
③	394	299	16	x1	1/1
④	374	289	16	x2	1/1
⑤	404	388	3	x2	1/1
⑥	387	381	16	x2	1/1
					1/1

1 ▶

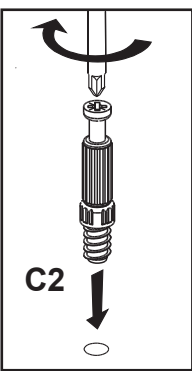
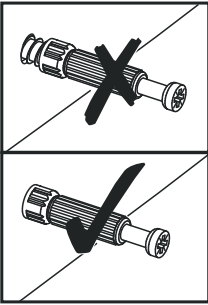
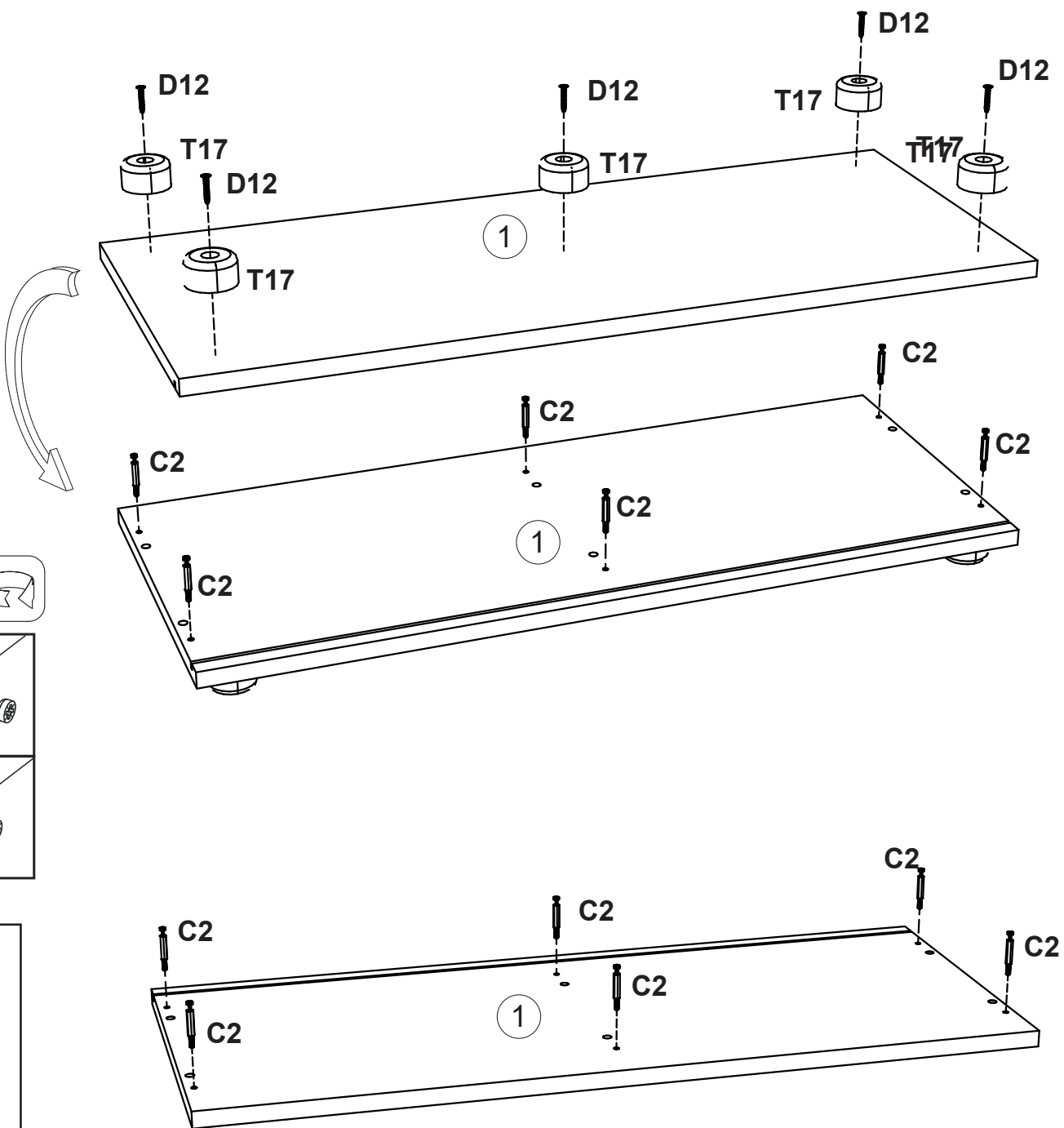
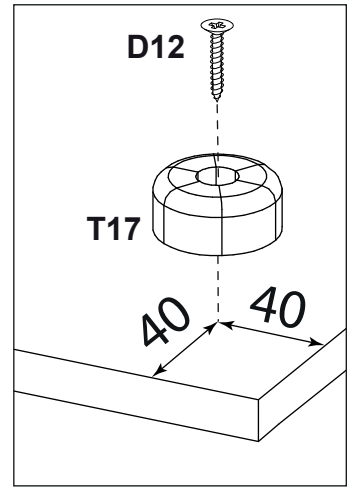
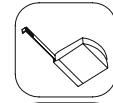
C2  x12	D12  x5
T17  x5	

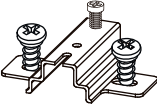

2 ▶

A0/1 	x12	C7 	x12
Q0 	x8	J6 	x4

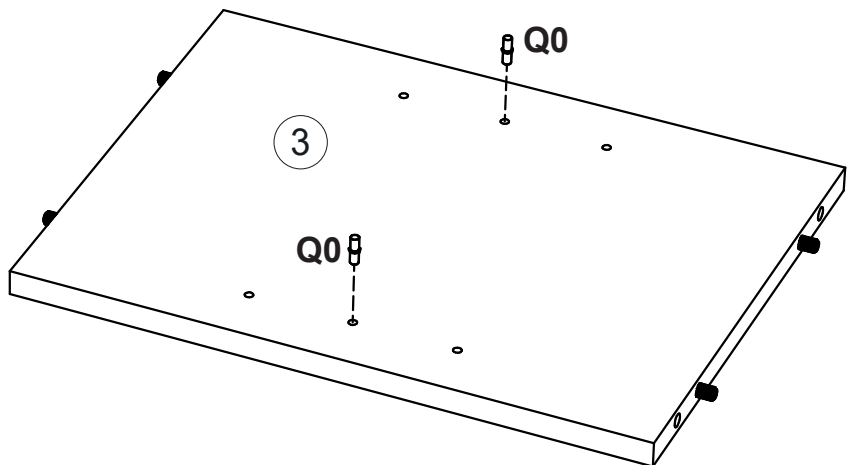
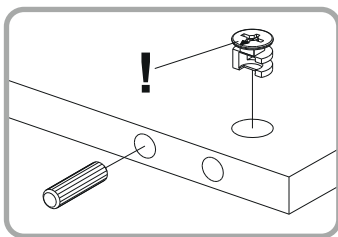
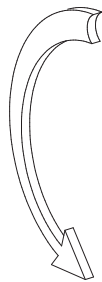
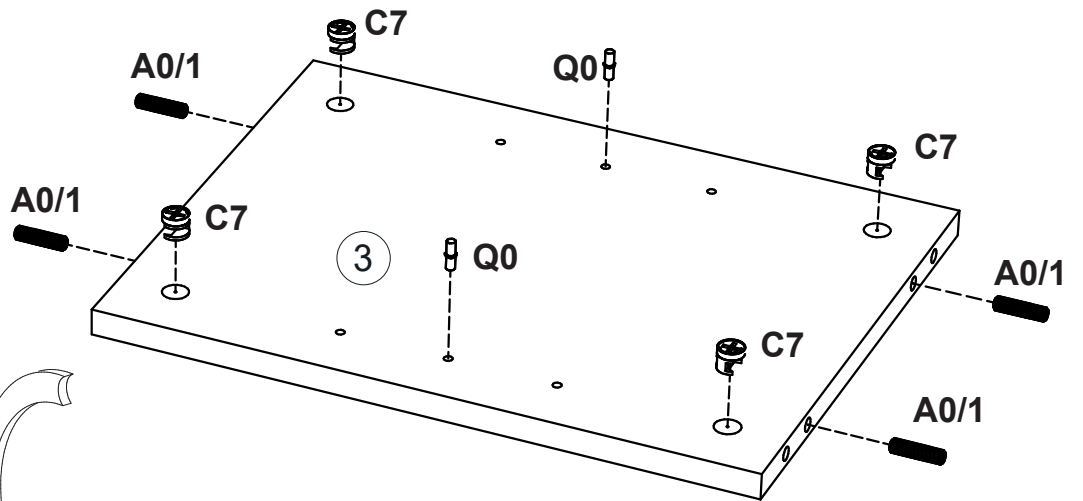
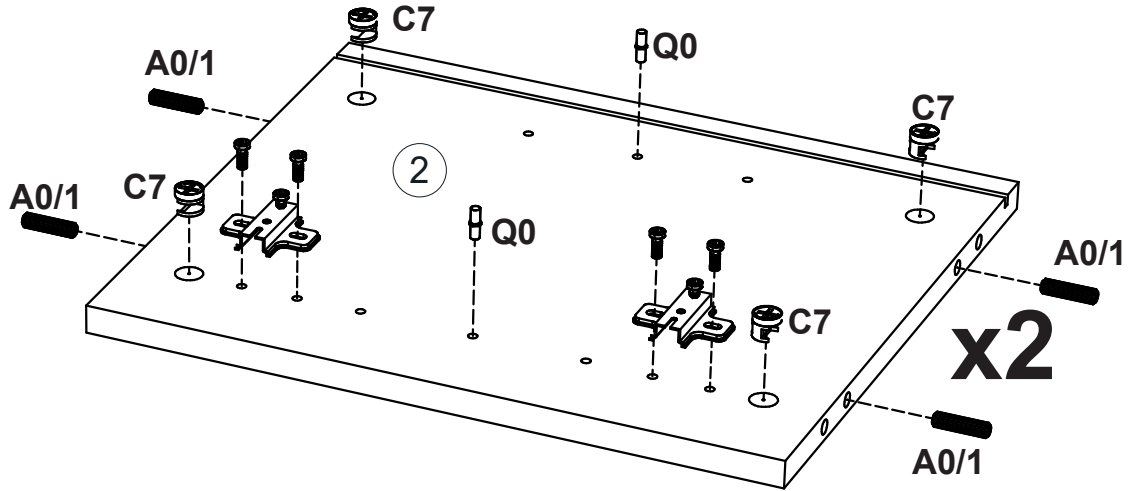
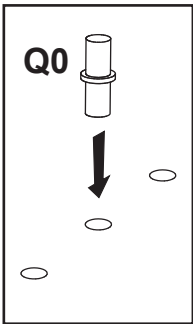
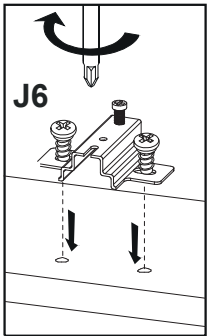
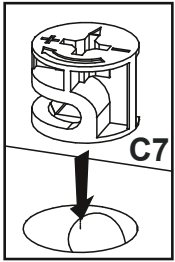

3 ▶

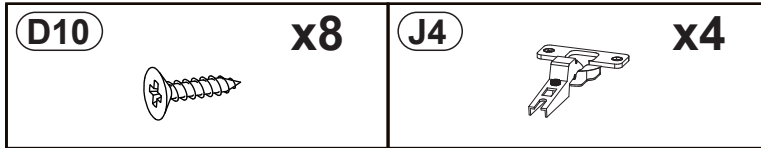

x2

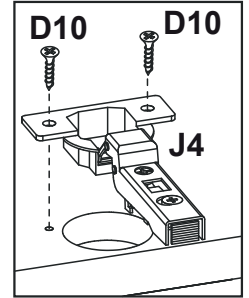
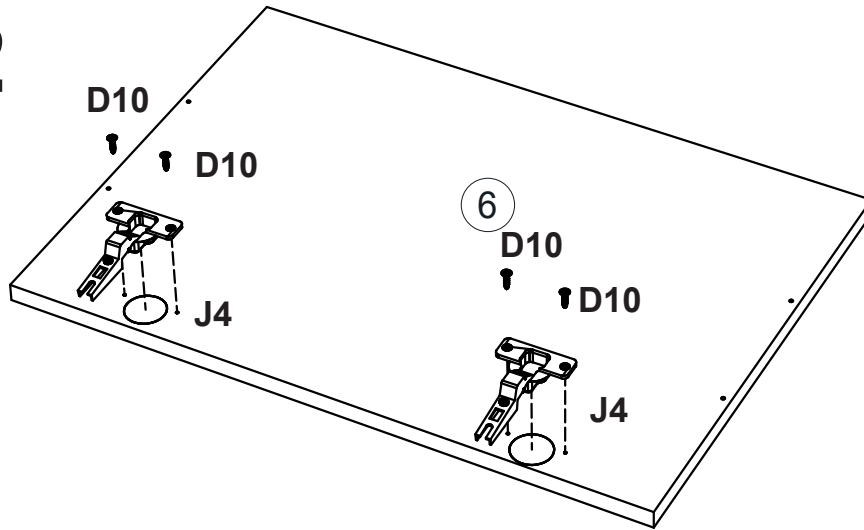

4 ▶

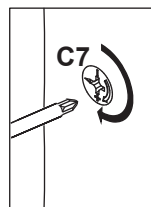
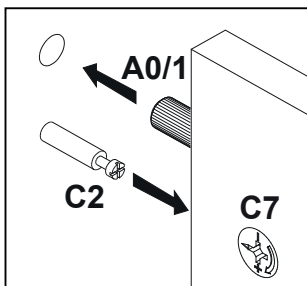
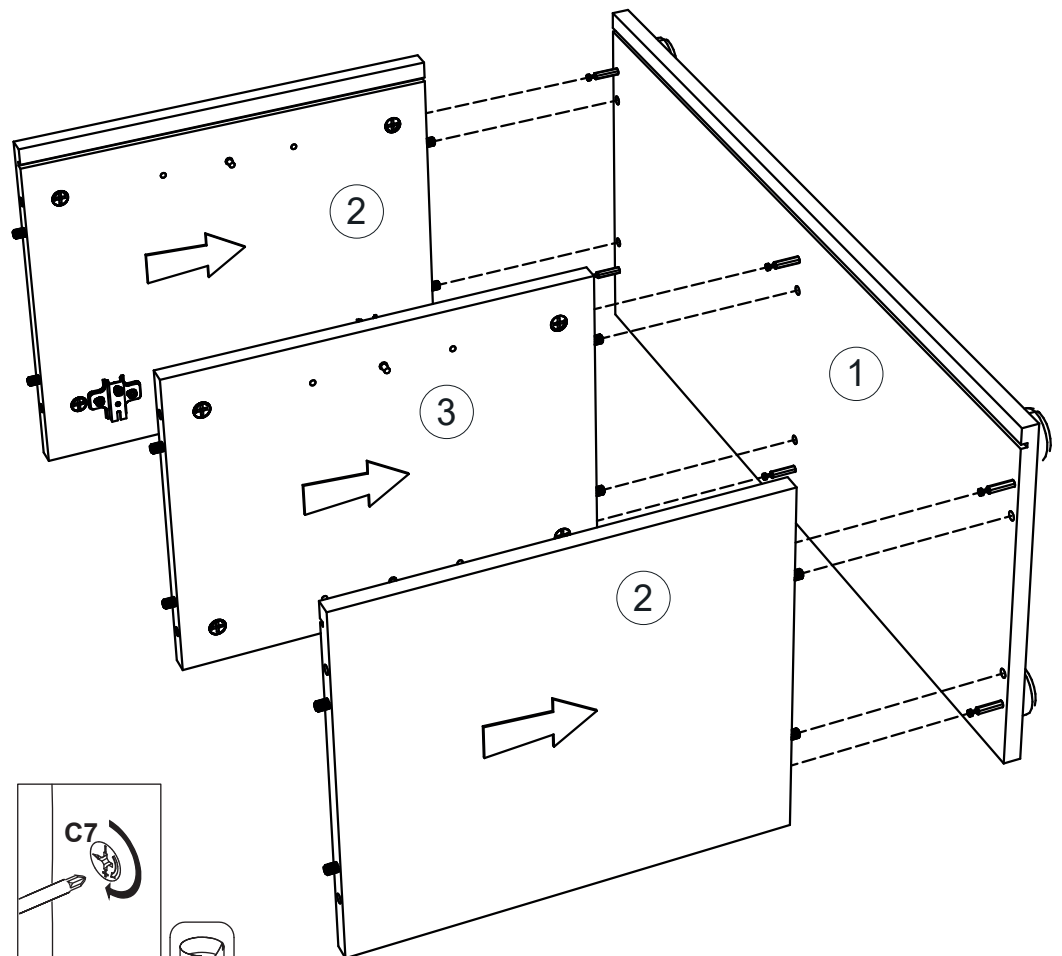
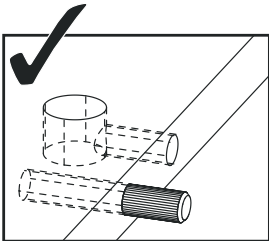
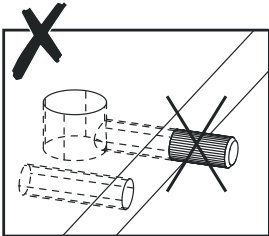

5 ▶

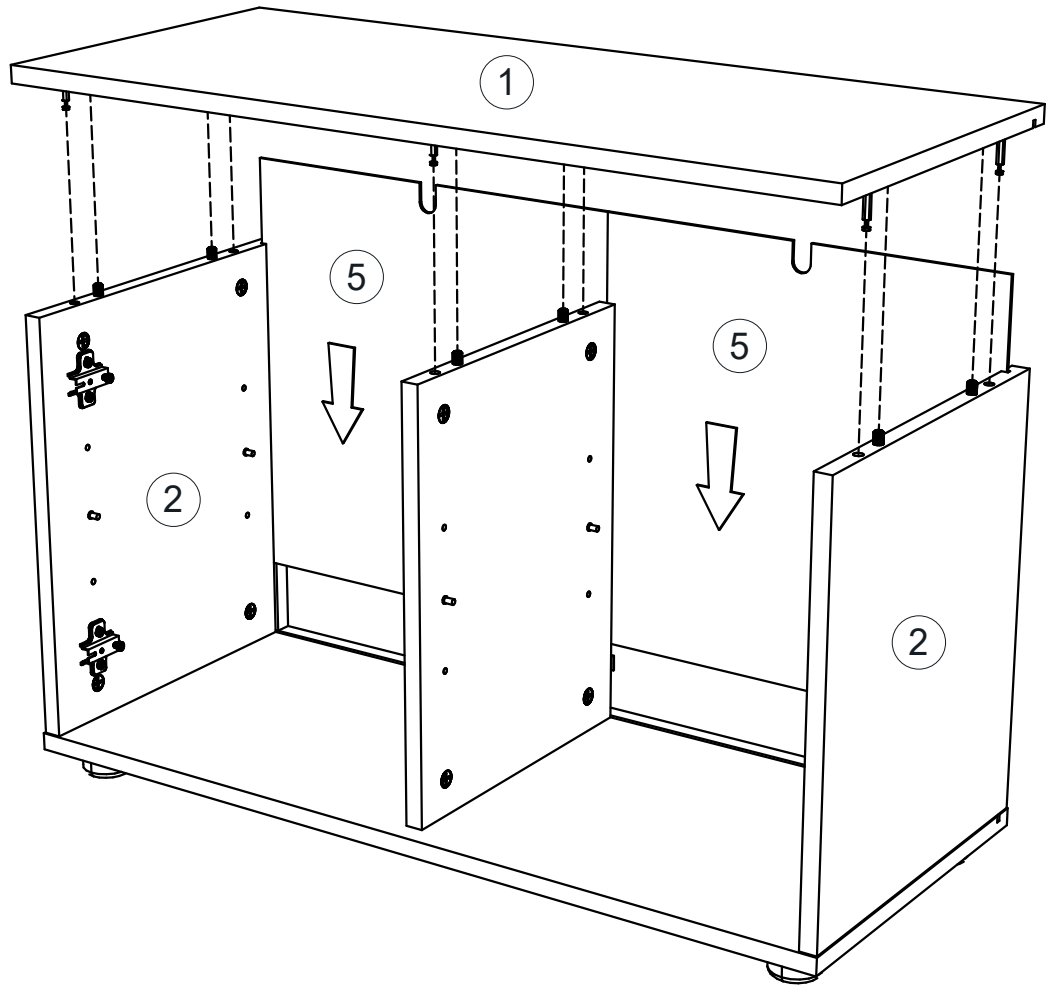

6 ▶

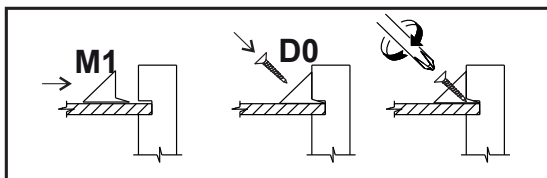
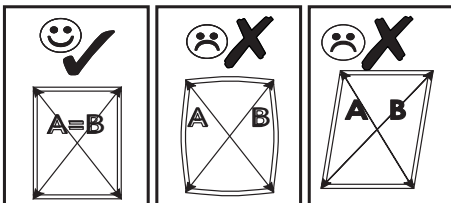
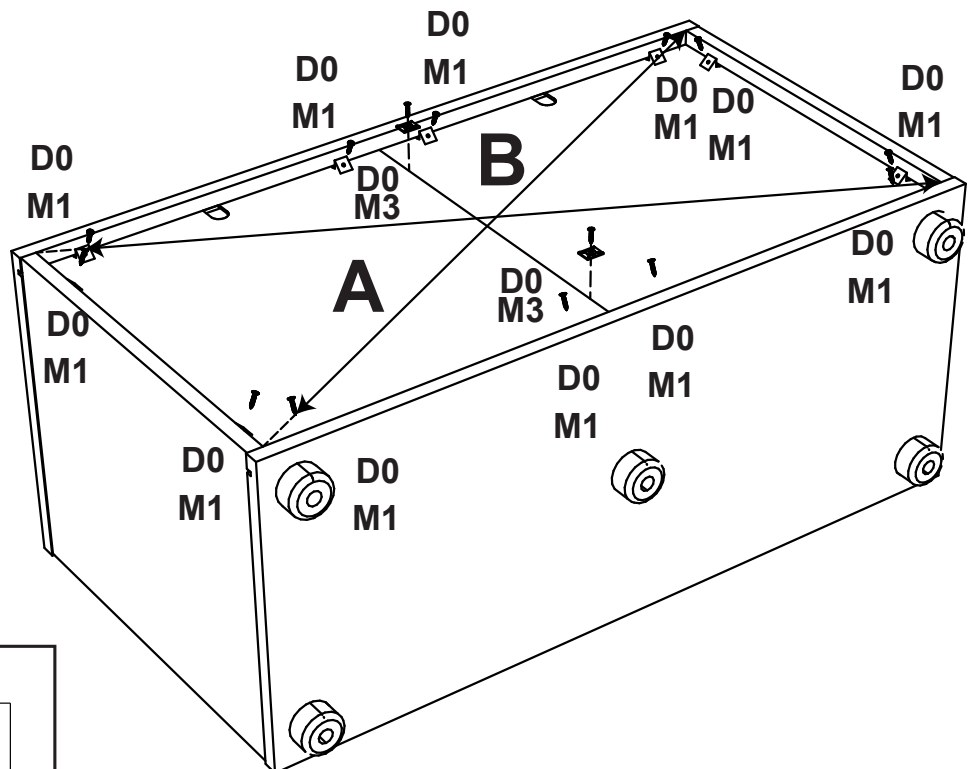
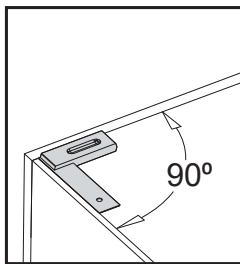
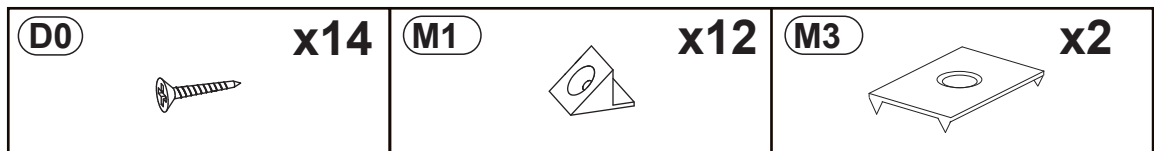

7

D36	x4	E0	5 x 50 mm 8 x 50 mm	x2	P0	x2
------------	-----------	-----------	------------------------	-----------	-----------	-----------

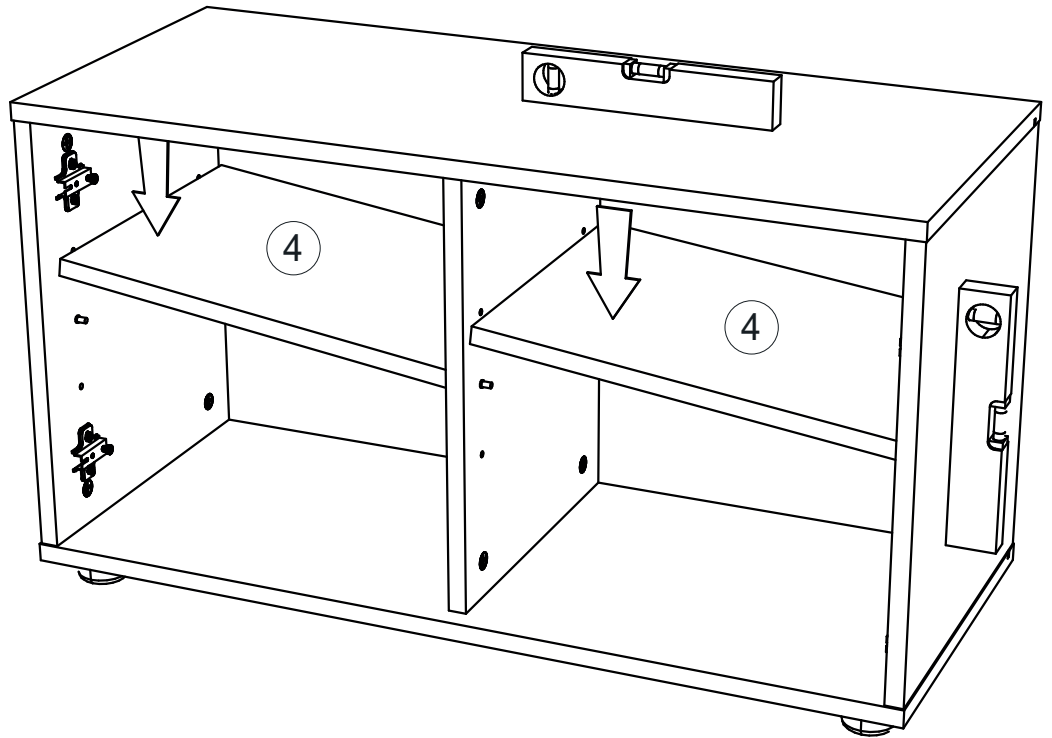
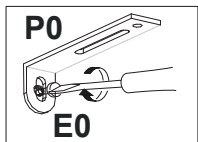
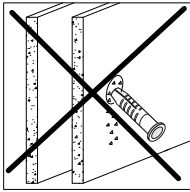
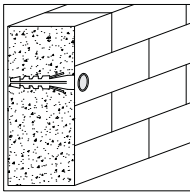
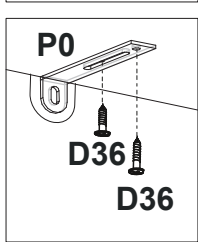
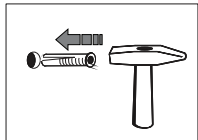
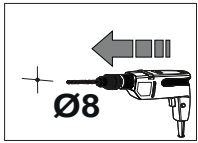
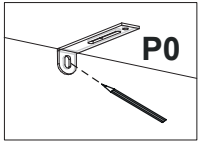

8

D8	x4	L43	x2	C0	x12
-----------	-----------	------------	-----------	-----------	------------

