

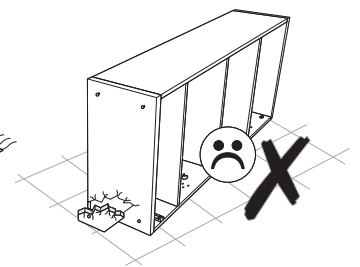

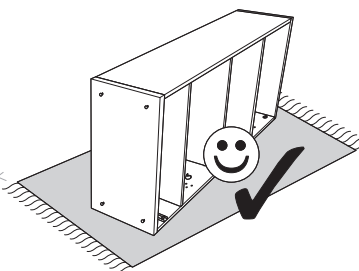

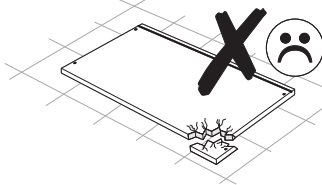

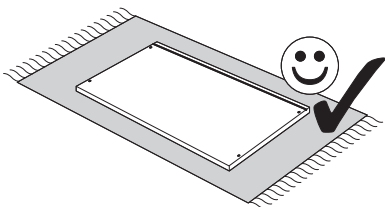

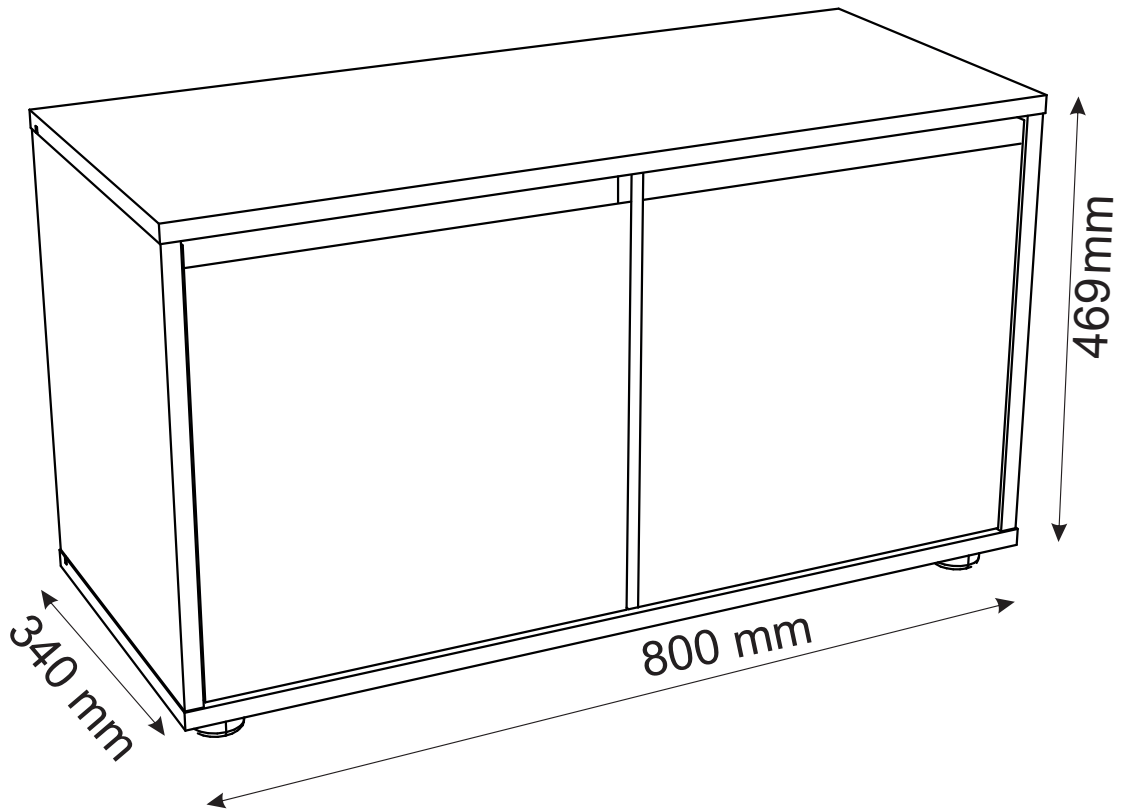
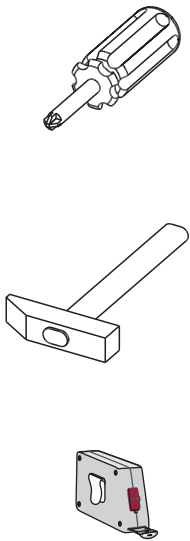
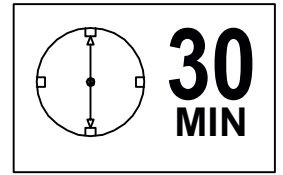
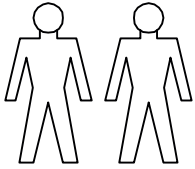
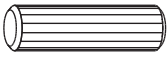

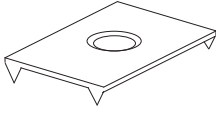
Shoe cabinet 2D

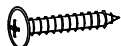
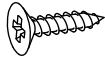
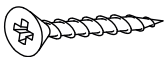

Shoe cabinet 2D

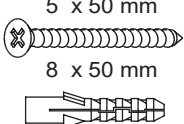
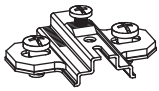
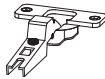
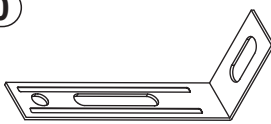
MM

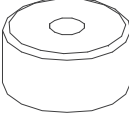
A0/1 8 x 30mm x16 	A0/1 8 x 50mm x2 	M3  x2
C0  x12	C2  x12	C7 16mm  x12
D0 3 x 15 mm x14 	D36 3.5 x 16 mm x4 	D10 4 x 16 mm x8 
D12 4 x 25 mm x5 	M1  x12	E0 5 x 50 mm 8 x 50 mm x2 
J6  x4	J4  x4	P0  x2
Q0  x8	T17  x5	

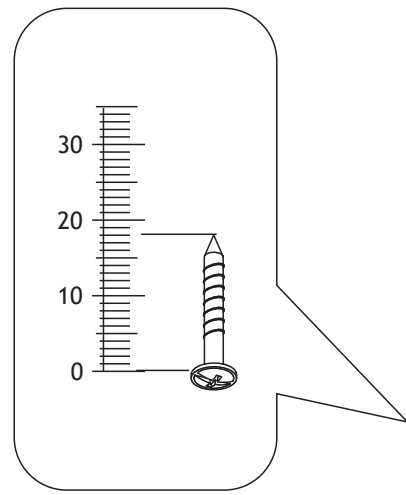
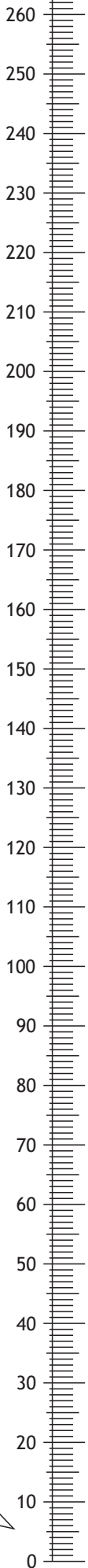

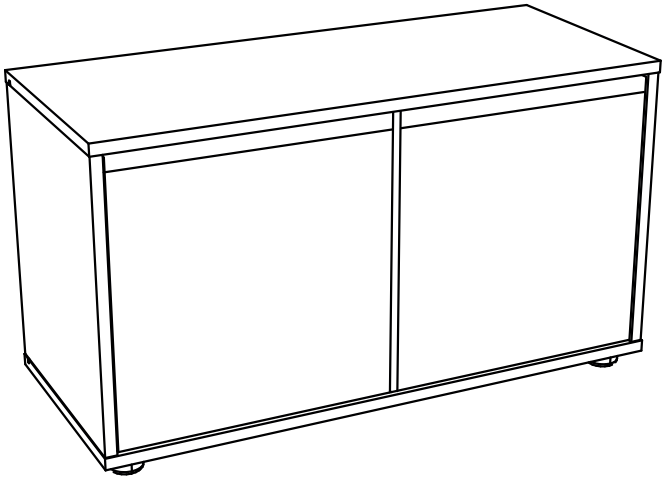
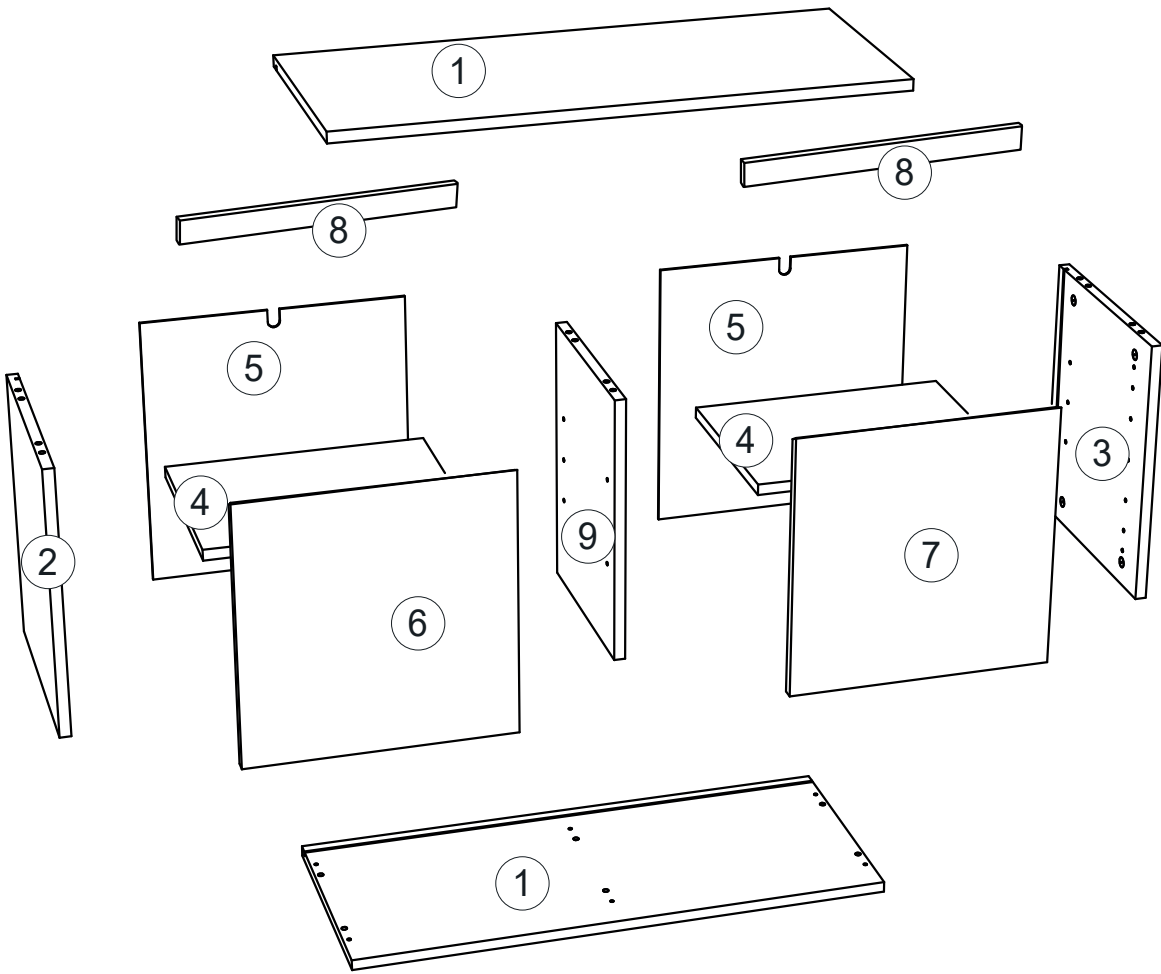

Shoe cabinet 2D





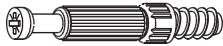

1	800	340	16	x2	1/1
2	412	338	16	x1	1/1
3	412	338	16	x1	1/1
4	374	289	16	x2	1/1
5	422	388	3	x2	1/1
6	379	371	16	x1	1/1
7	379	371	16	x1	1/1
8	375	60	3	x2	1/1
9	412	318	16	x2	1/1
					1/1

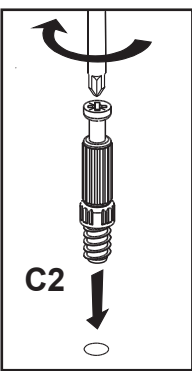
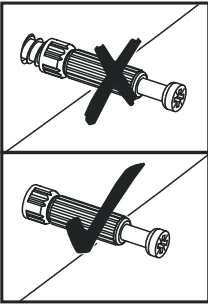
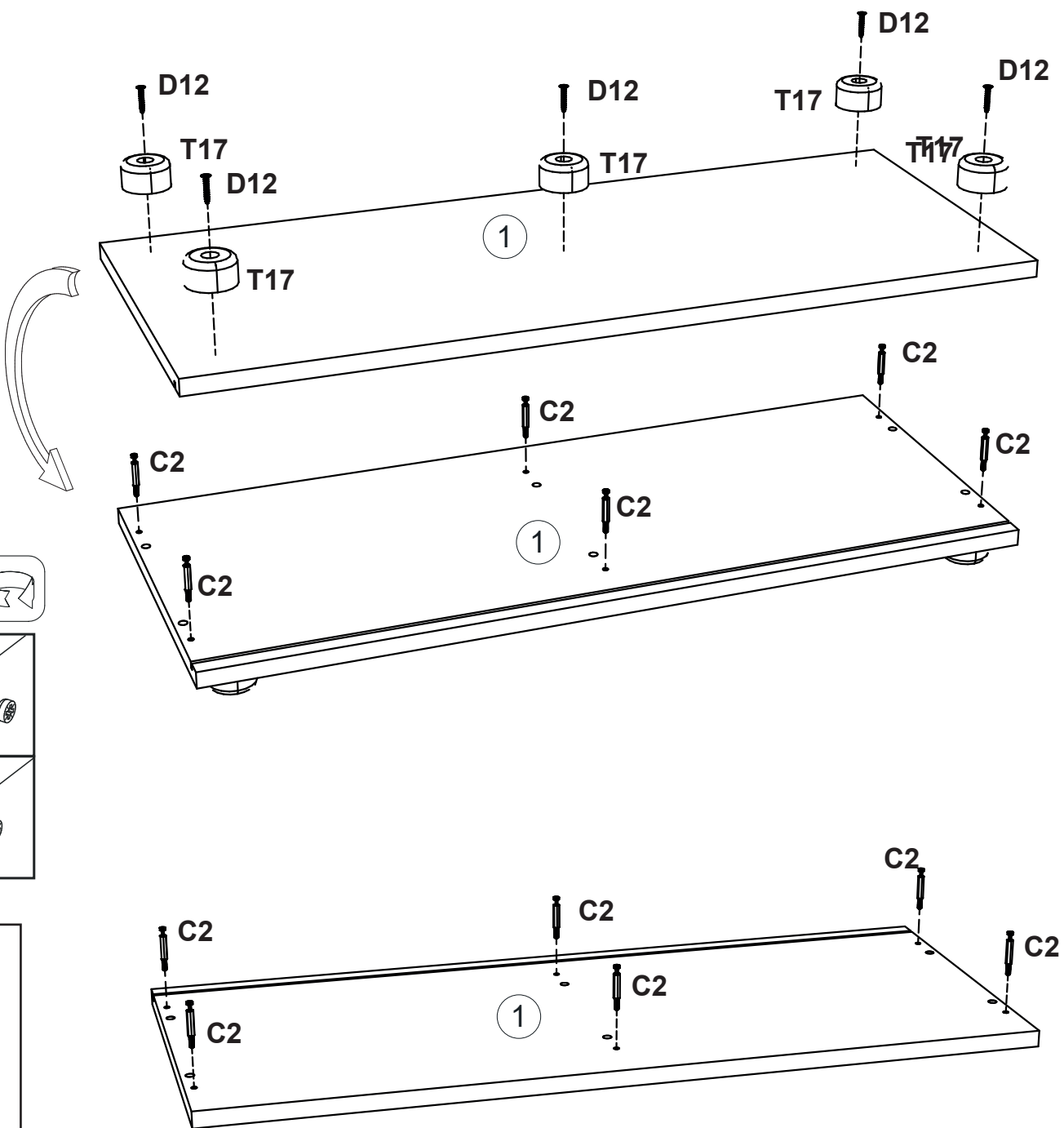
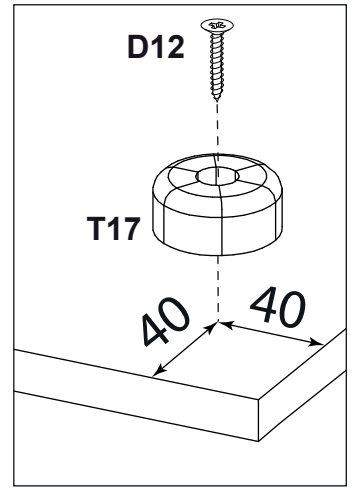
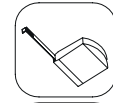
1 ▶

C2  x12	D12  x5
T17  x5	



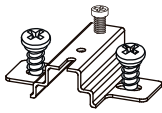

2 ▶

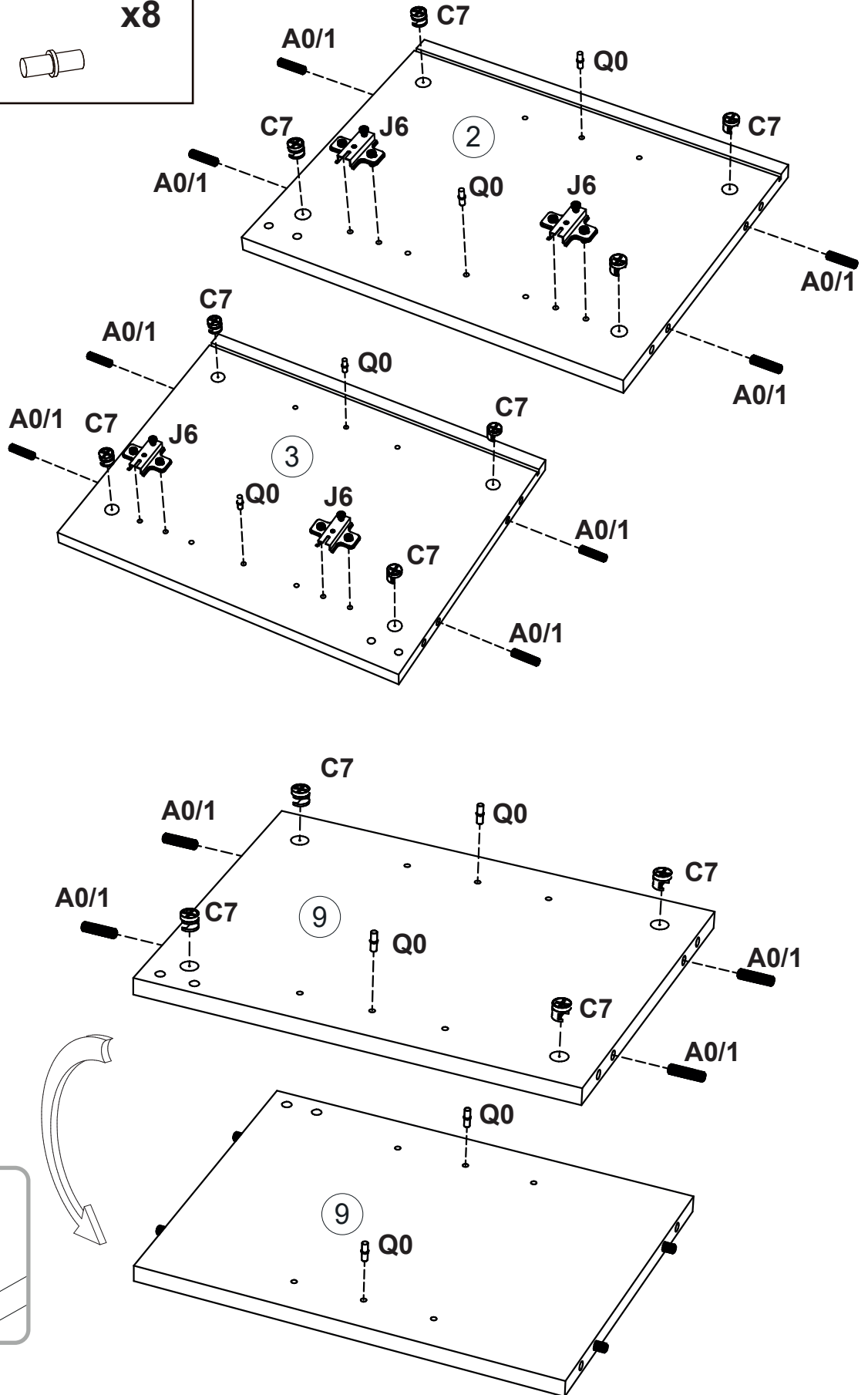
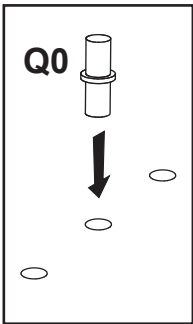
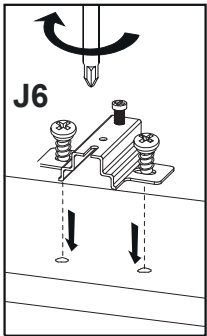
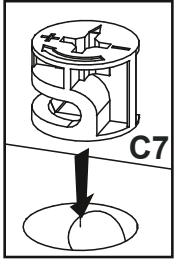
A0/1  x12	C7  x12	J6  x4
Q0  x8		

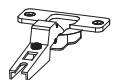

3 ▶

A0/1		x4	D10		x8	J4		x4
-------------	---	-----------	------------	---	-----------	-----------	---	-----------

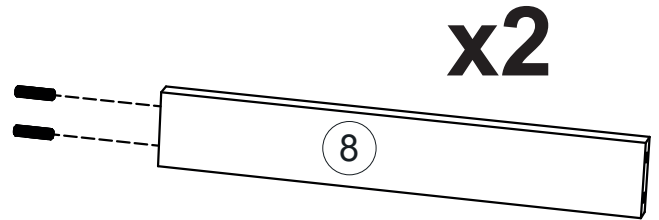
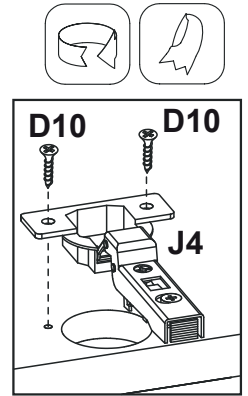
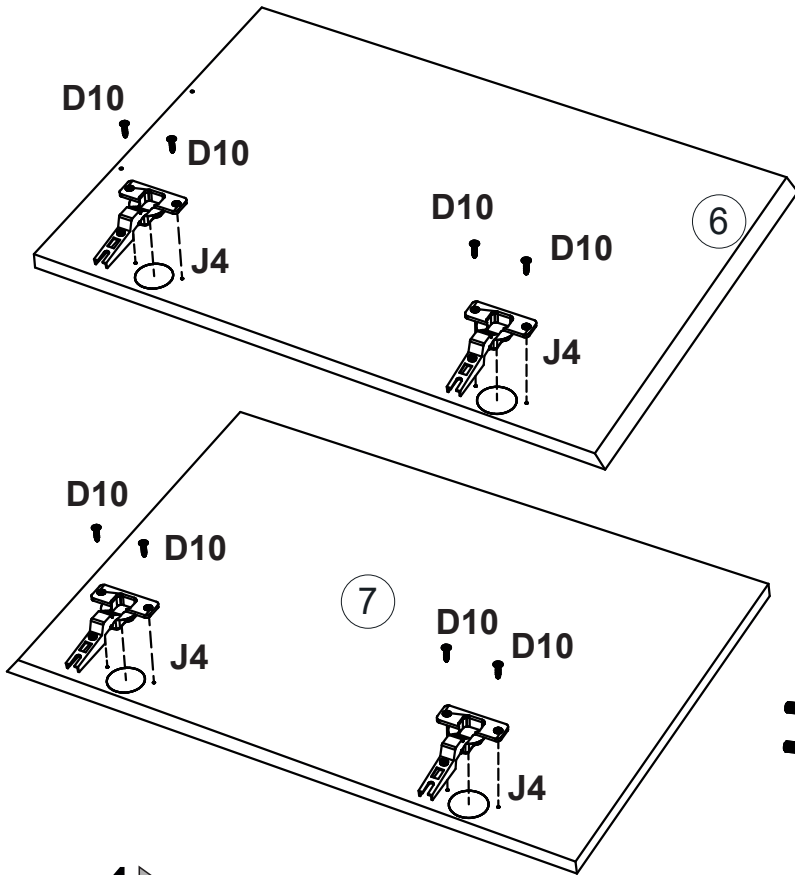

4 ▶

A0/2		x2
-------------	---	-----------

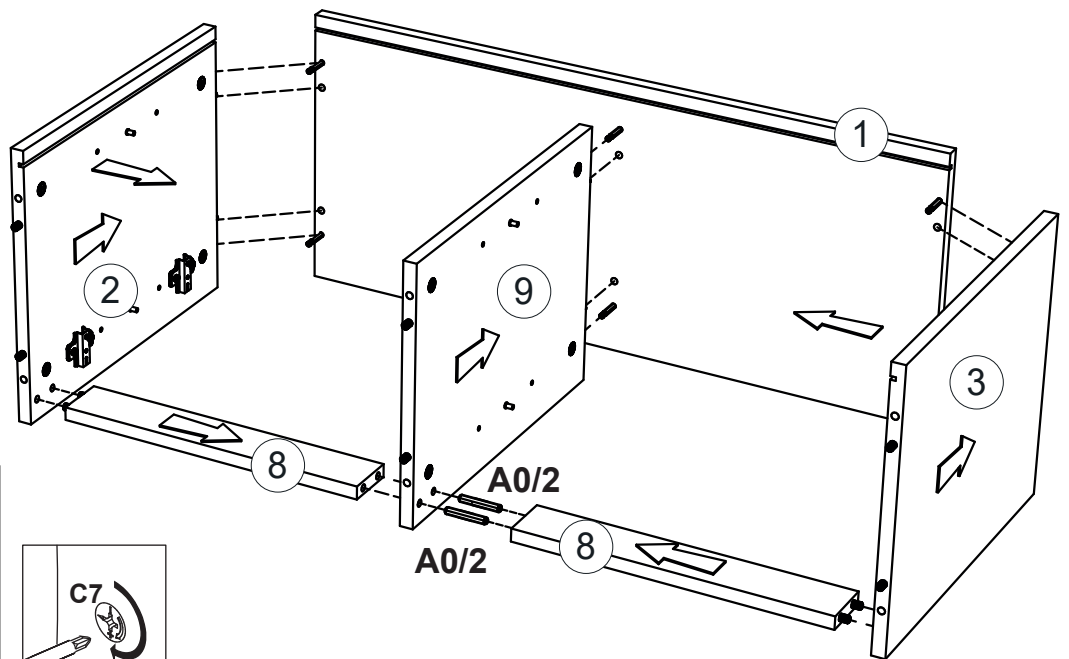
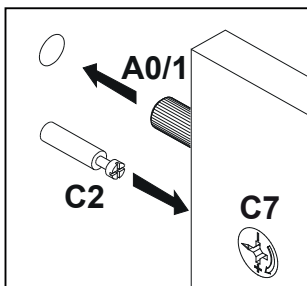
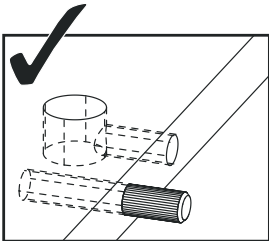
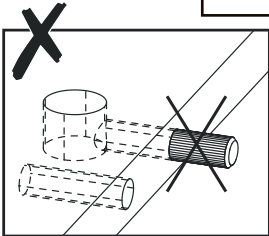

5 ▶

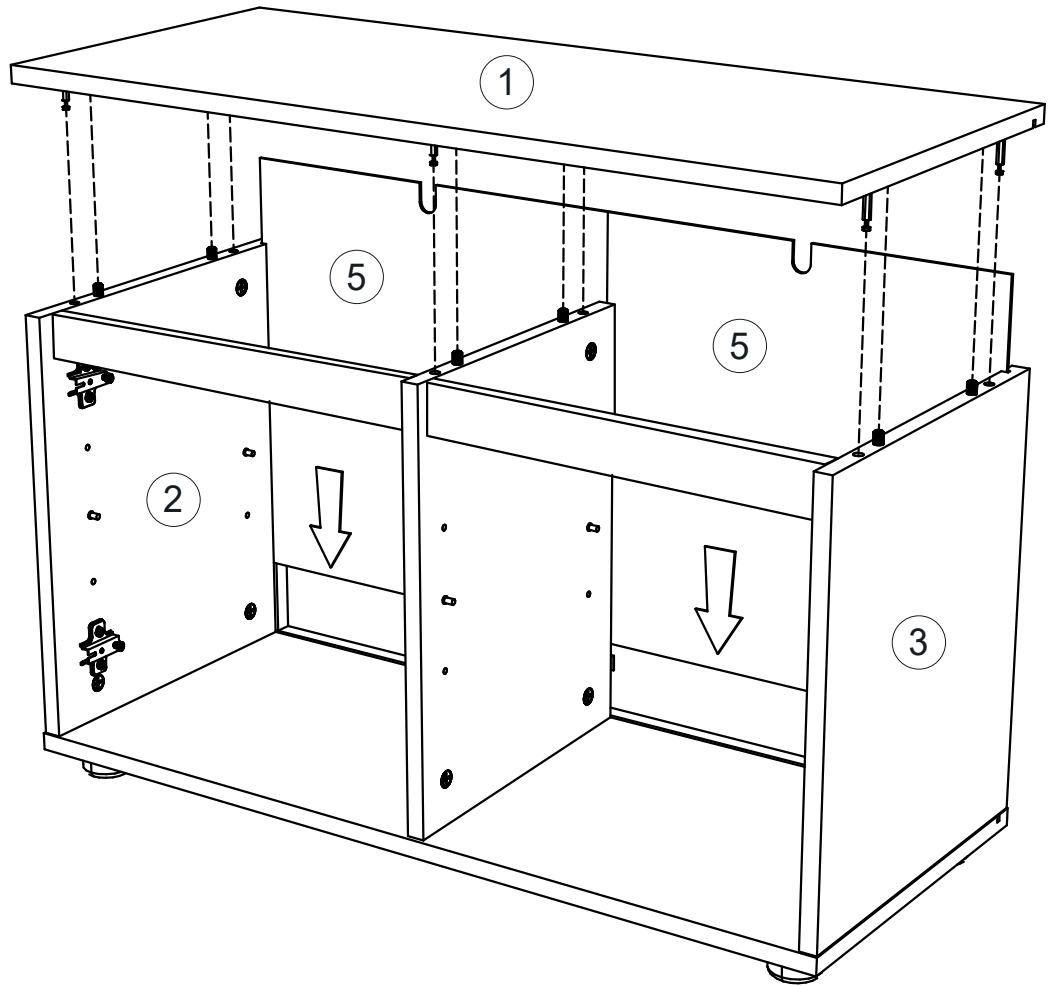

6 ▶

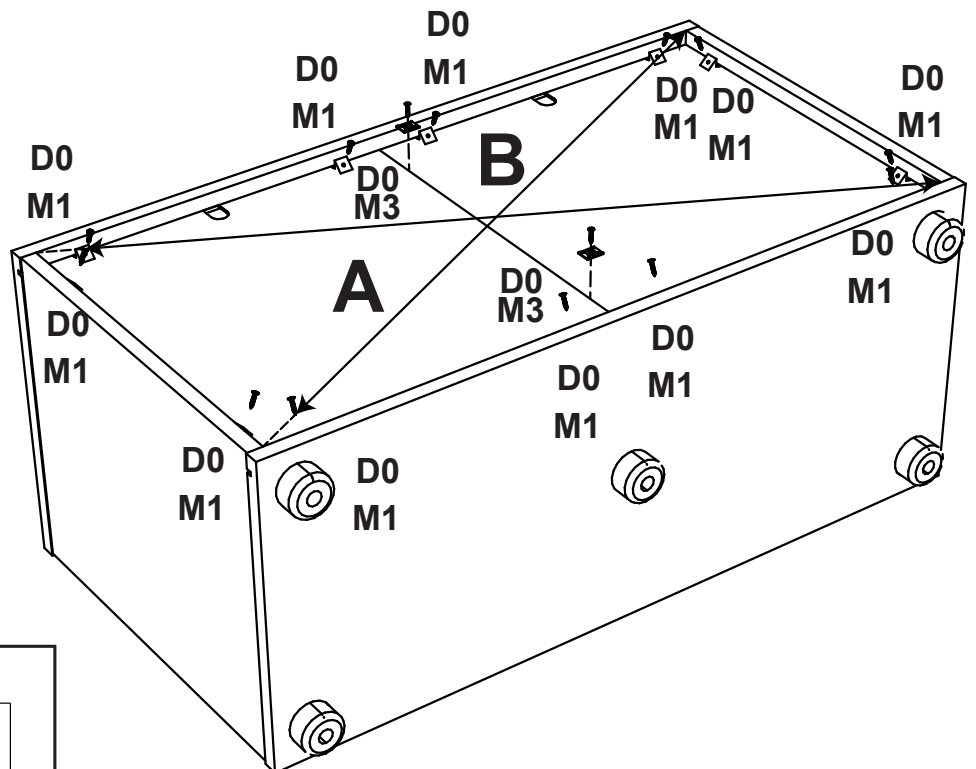
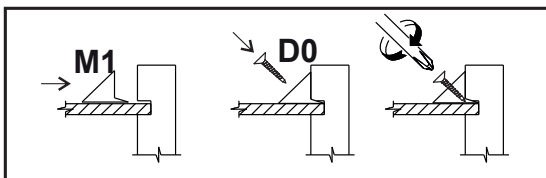
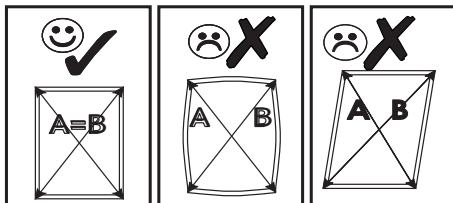
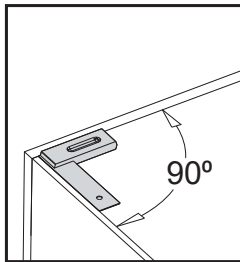
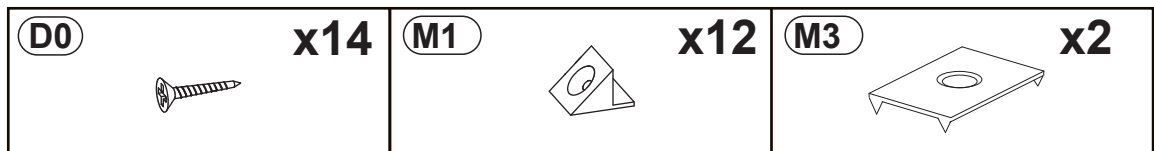

7

D36	x4	E0	x2	P0	x2

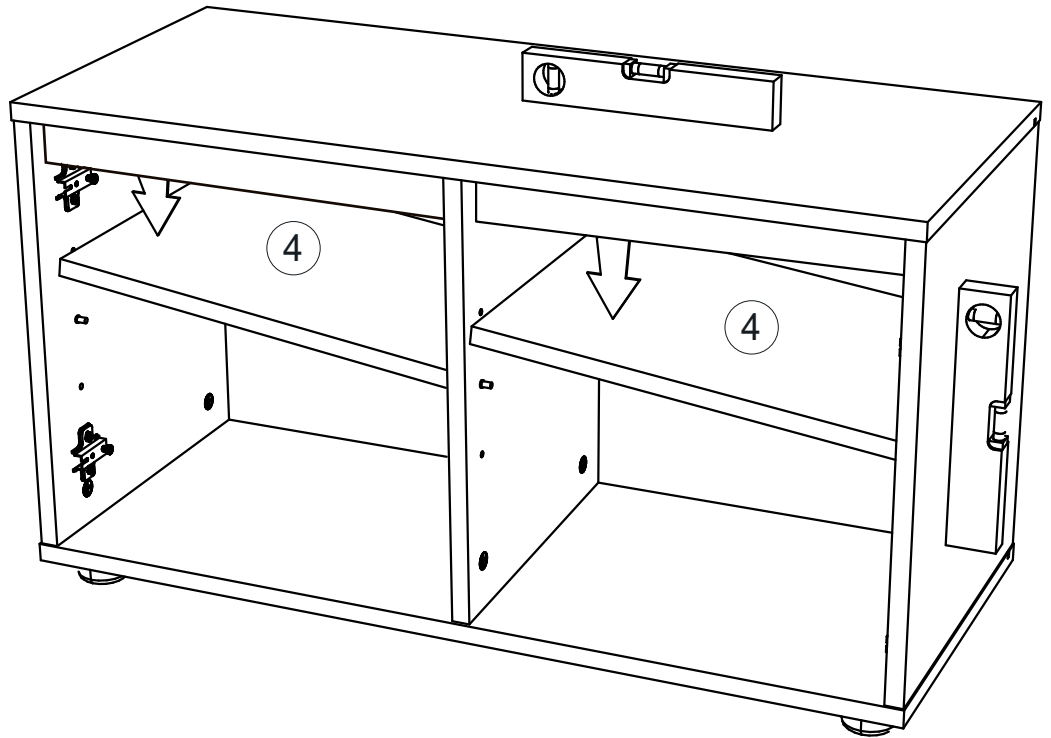
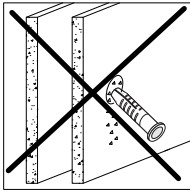
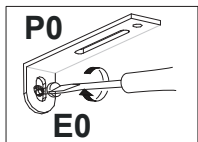
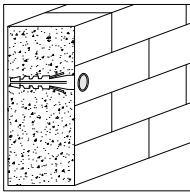
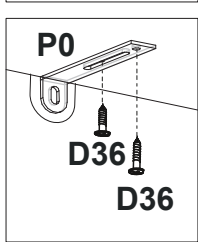
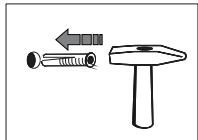
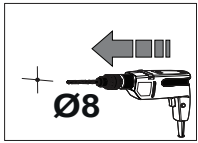
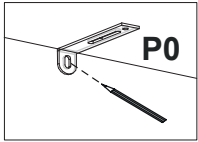

8

C0	x12

