

BURGAS

1 / 6

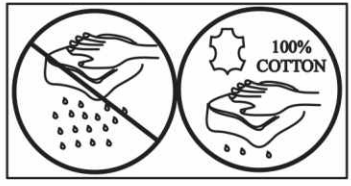

100% COTTON

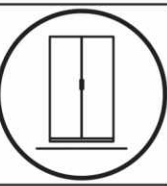
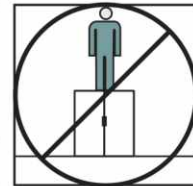
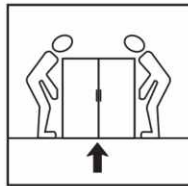
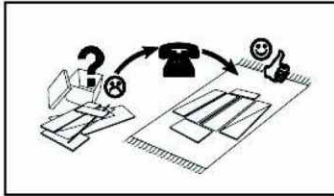
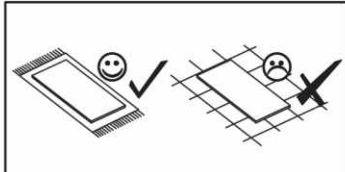
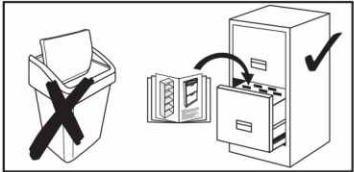
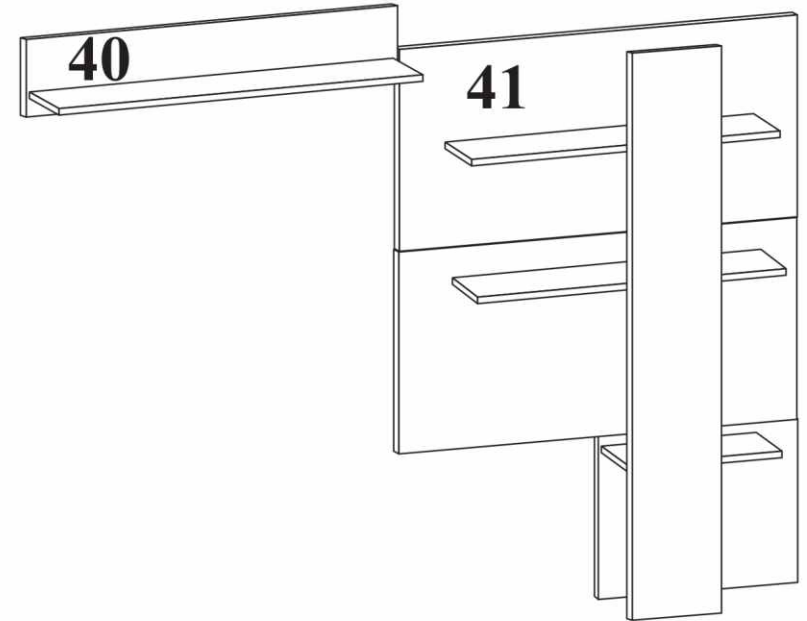
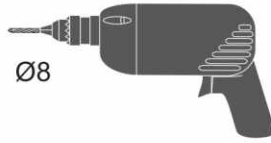
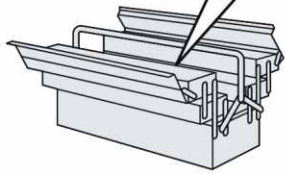
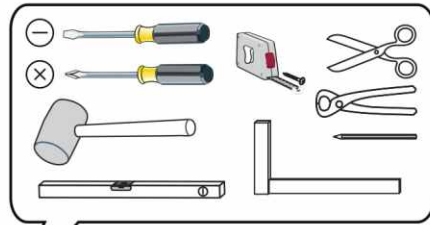
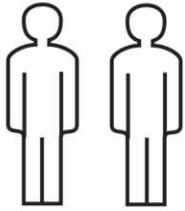
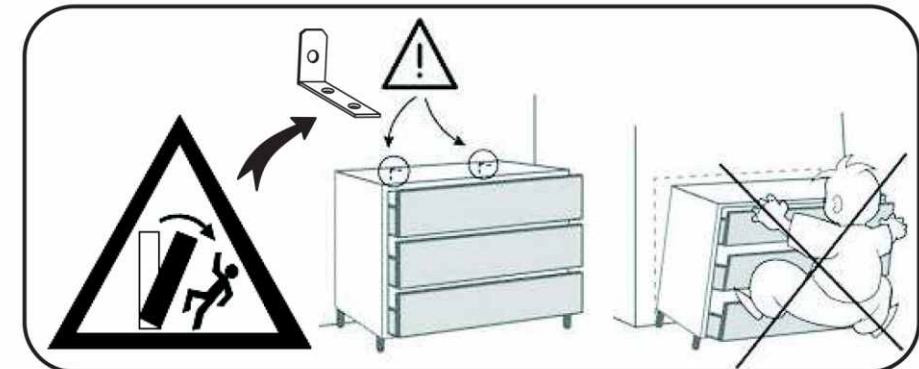
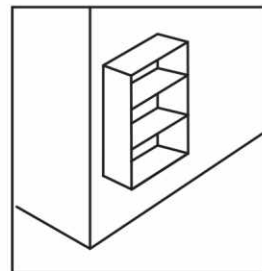
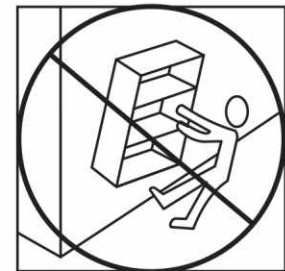
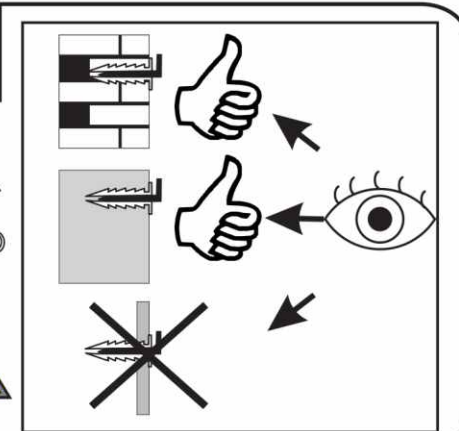

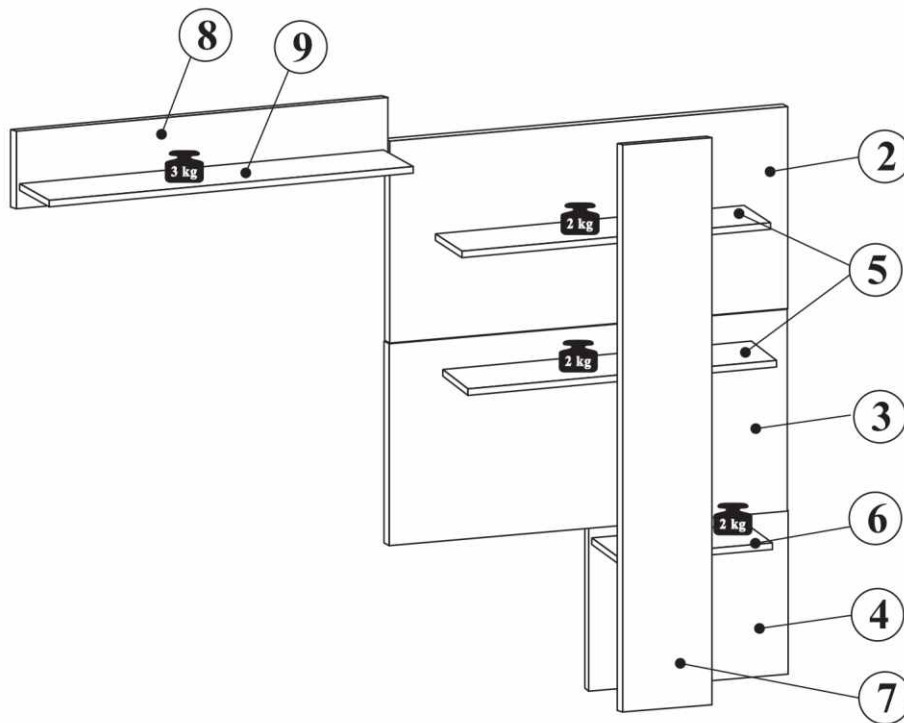
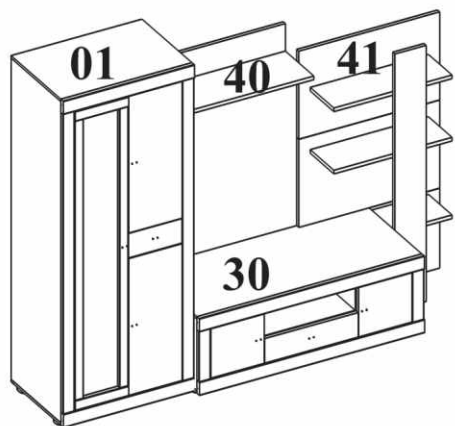

Nr 1

(B1) ϕ 8x28 x6

(M1) ϕ 15x12mm x3

(T1) 5x39mm x3

(K1) 7x50 x15

Nr 2

(F50) x5

(E2) 6x8 x10

(T10) x5

(F18) x5

(E24) 6,0x11 x20

Nr 3

(C14) ϕ 20mm x3

(F15) x2

(C22) 3,5mm x3

(L1) x1

2	990	535	1	4/4
3	990	535	1	4/4
4	495	485	1	4/4
5	830	166	2	4/4
6	415	166	1	4/4
7	1555	220	1	4/4
8	900	240	1	4/4
9	898	200	1	4/4



1

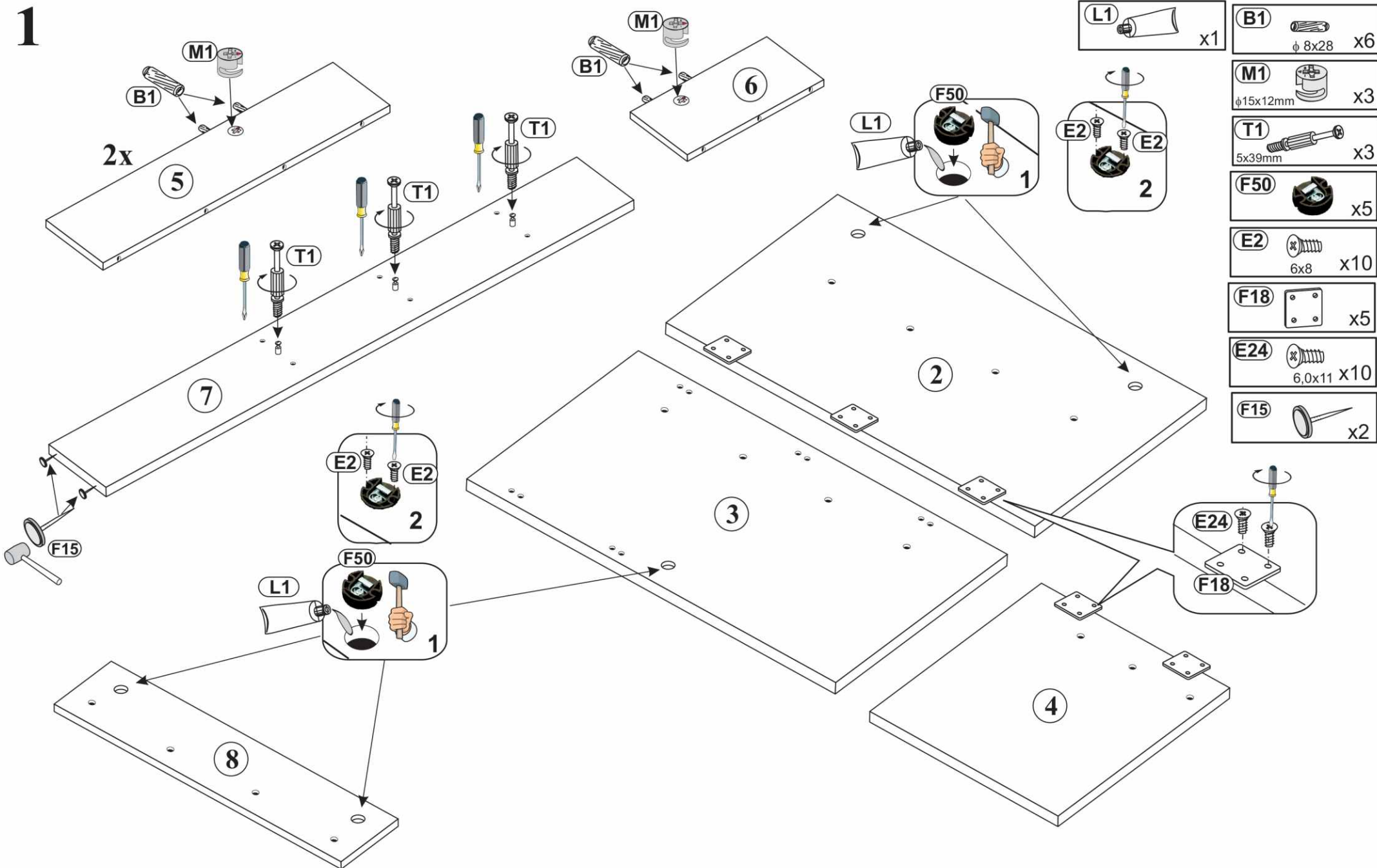

4

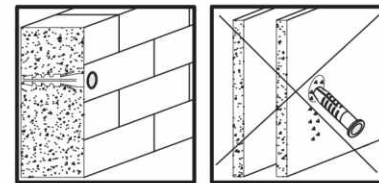
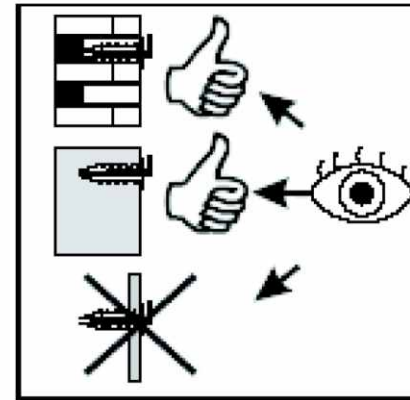
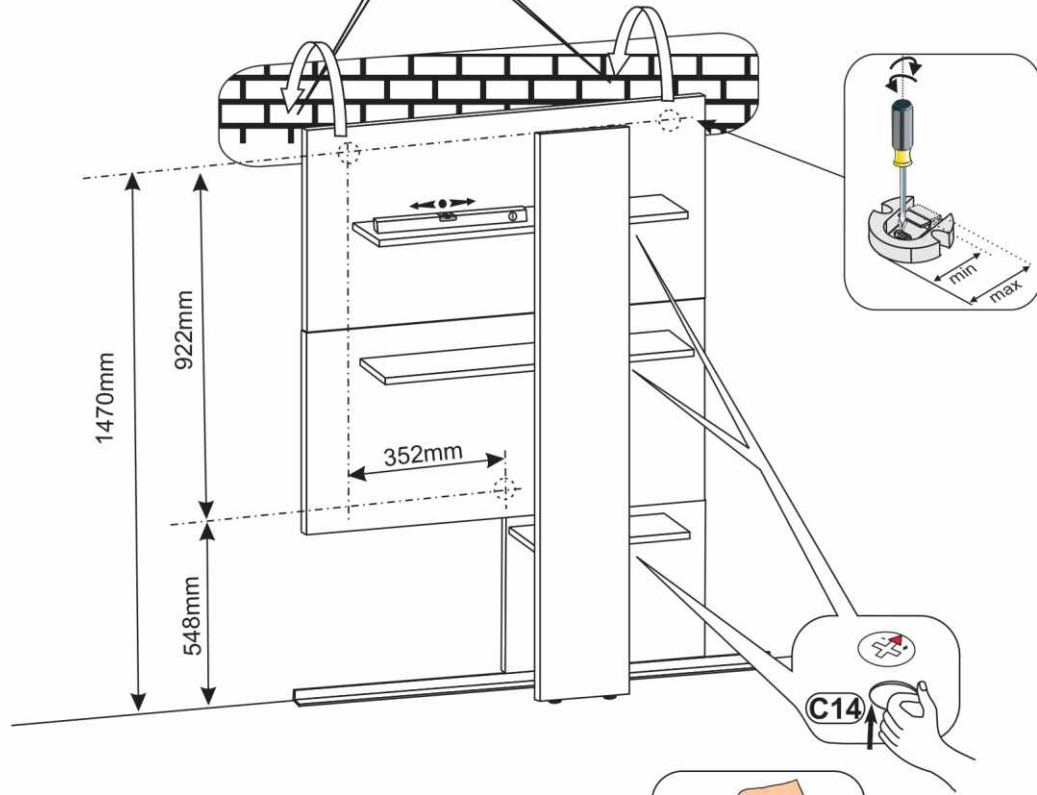
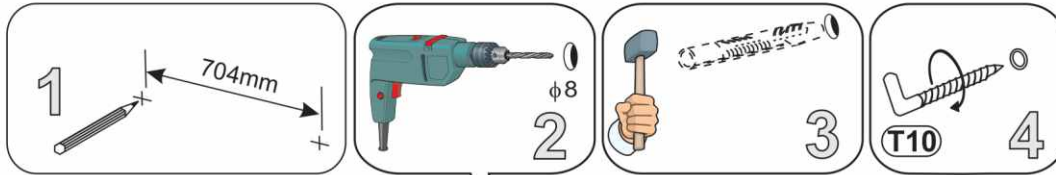
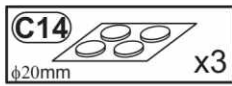

5

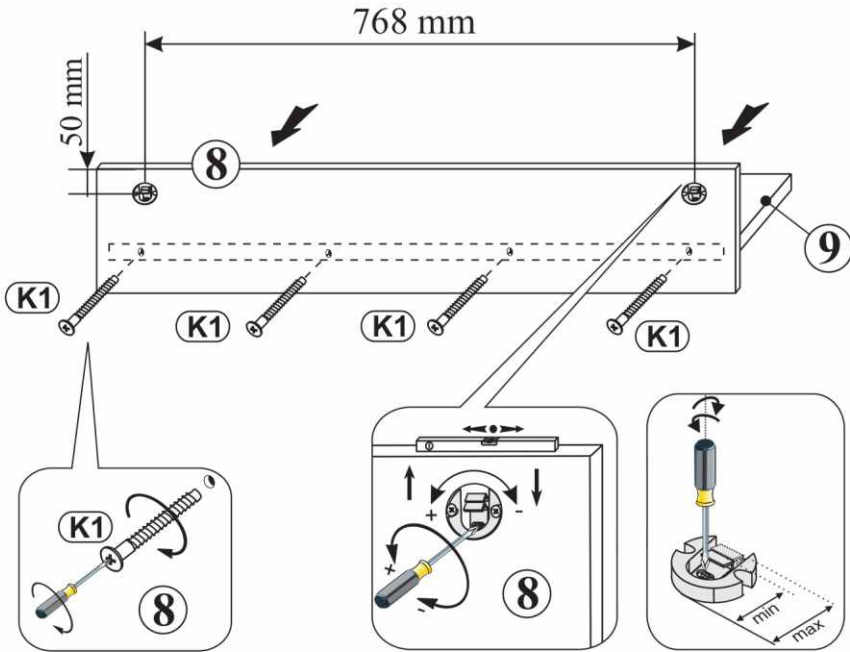
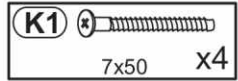

6

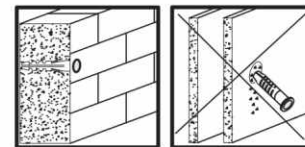
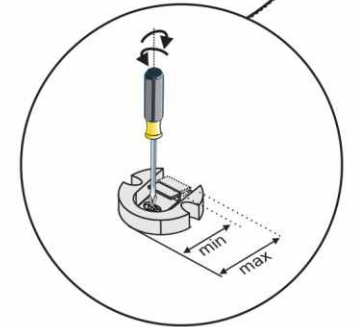
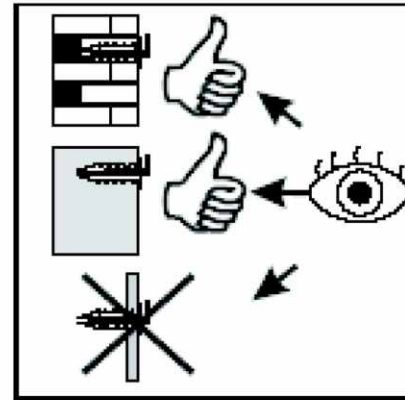
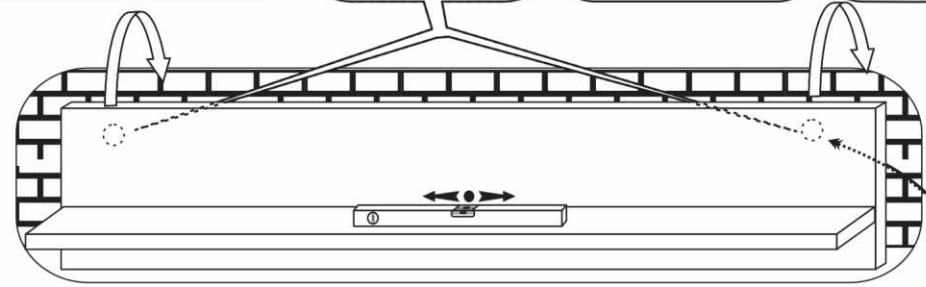
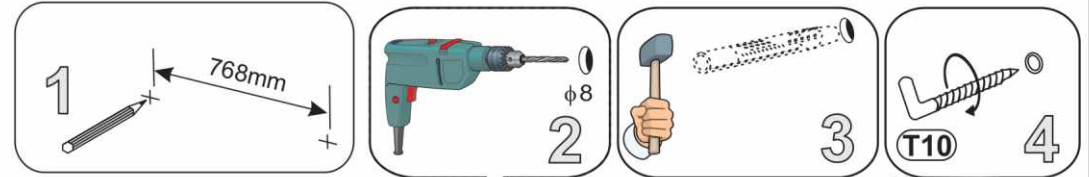

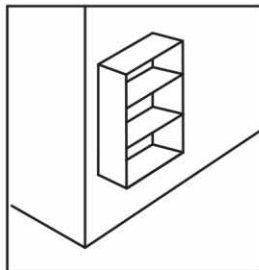
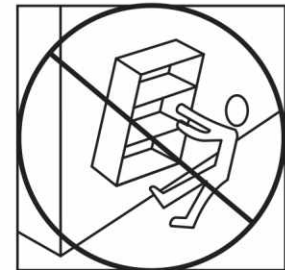
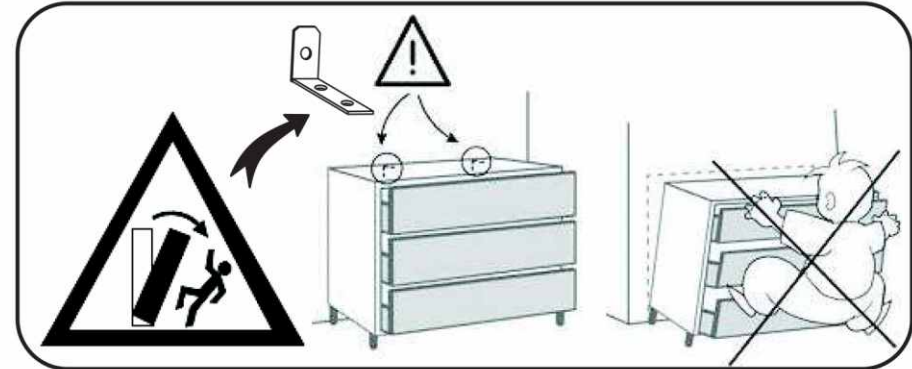
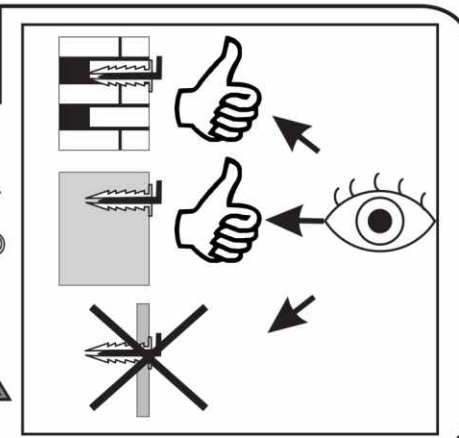
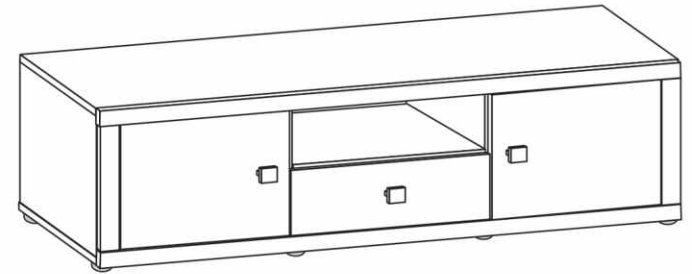
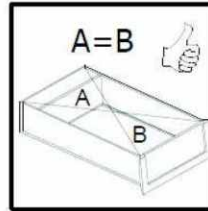
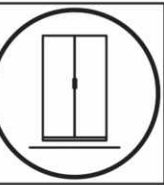
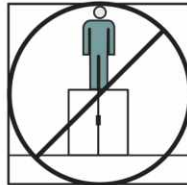
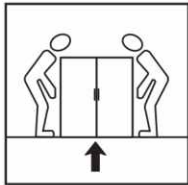
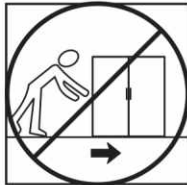
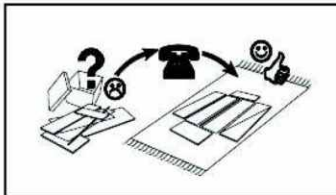
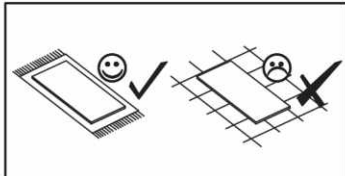
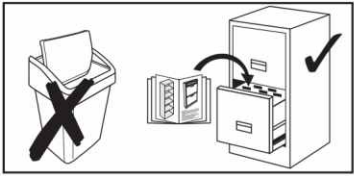
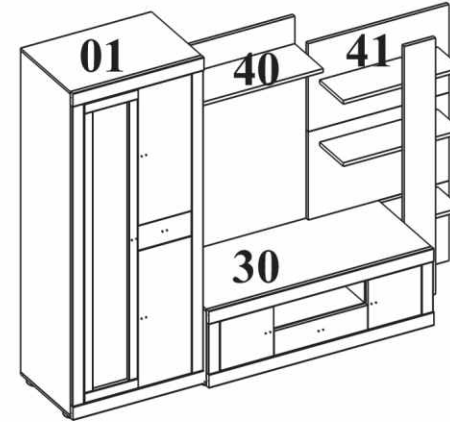
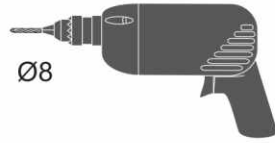
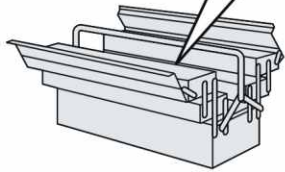
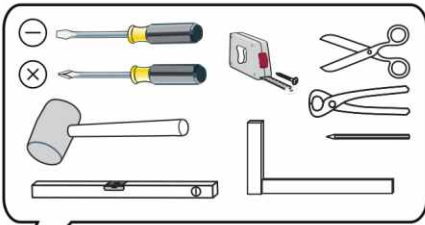
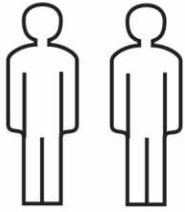

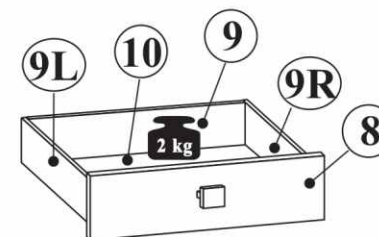
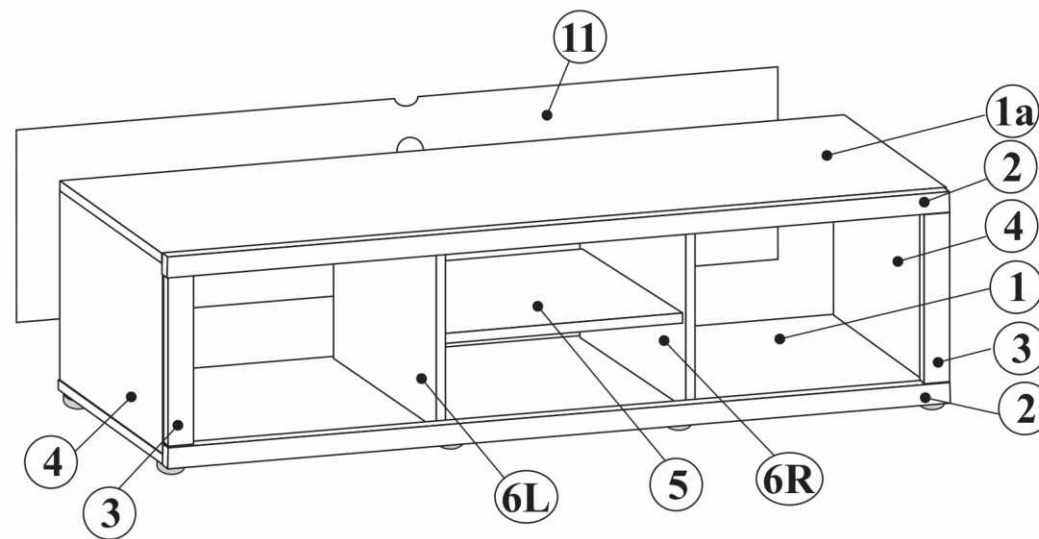
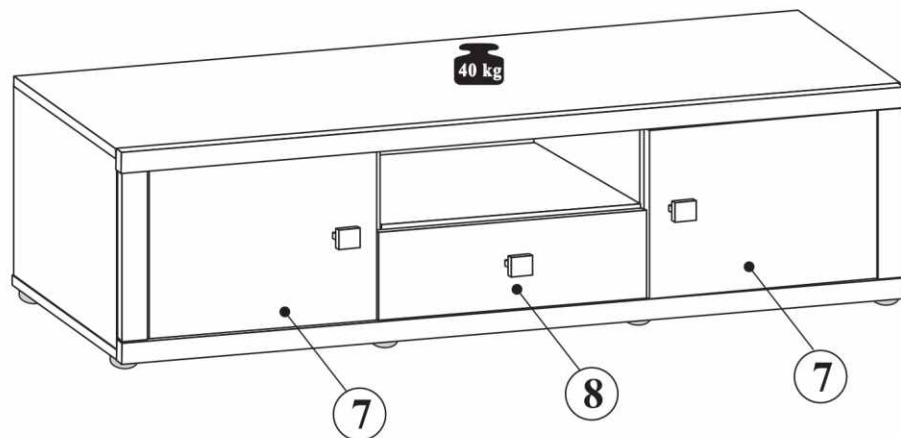





1	1580	385	1	3/4
1a	1580	385	1	3/4
2	1581	80	2	3/4
3	306	80	2	3/4
4	435	385	2	3/4
5	645	364	1	3/4
6L,6R	435	365	2	3/4
7	300	375	2	3/4
8	657	149	1	3/4
9L,9R	302	100	2	3/4
9	596	100	1	3/4
10	607	300	1	3/4
11	1557	443	1	3/4

NR 1

B1  $\phi 8 \times 28$ x28

M1  $\phi 15 \times 12 \text{mm}$ x20

T1  5x39mm x20

J23  x14

P2  3x20 x9

F33  x12

P13  3,5x13 x48

C14  $\phi 20 \text{mm}$ x12

NR 2

R21 L-300 mm  x1L/1R

E24  6,0x11 x6

S3  3,5x13 x2

P10  3x13 x4

NR 3

U84  x3

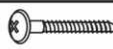
P4  4x25 x6

NR 4

M2  $\phi 12 \times 10 \text{mm}$ x2

T2  5x35mm x2

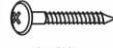
P5  4x30 x2

NR 5

F10  x8

P4  4x25 x8

J11  x1

P13  3,5x13 x2

NR 6

SR  $\phi 26$ x4

D4 H-4  x4

E3  6,3x13 x8

S8  4x13 x8



1

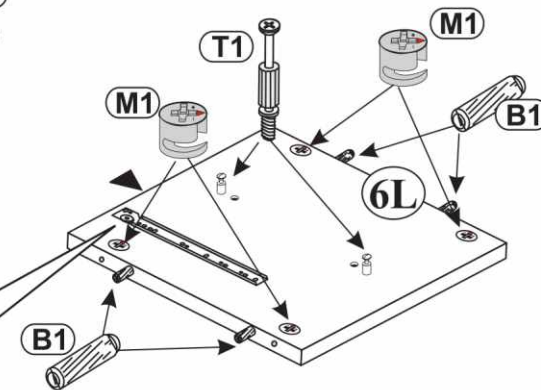
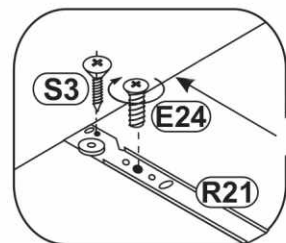
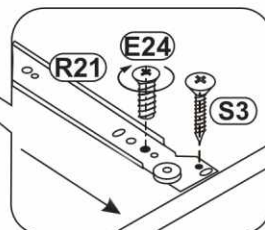
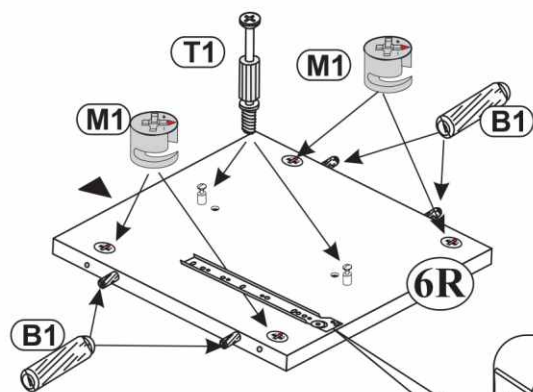
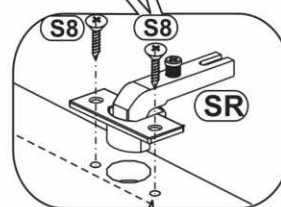
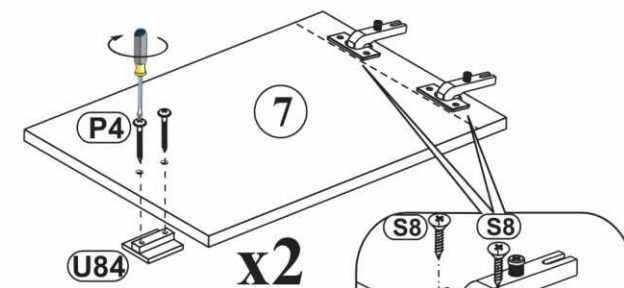
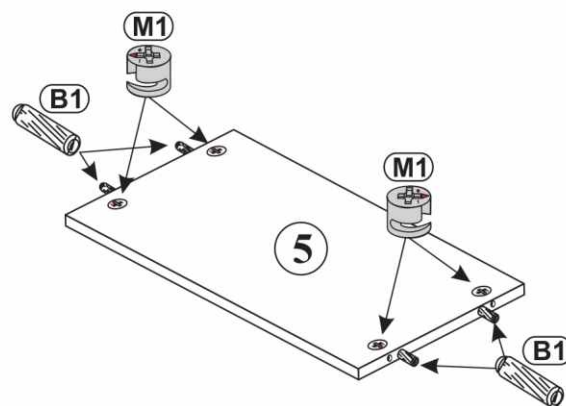
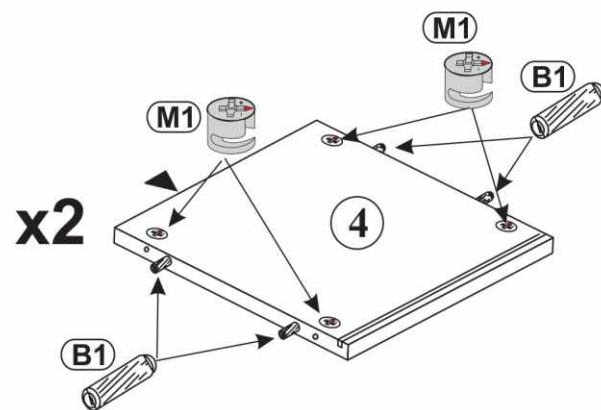
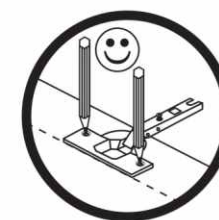
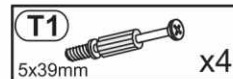
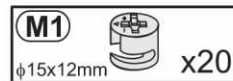
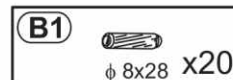
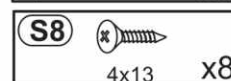
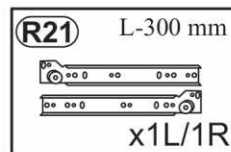
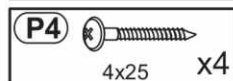
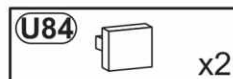
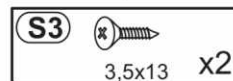
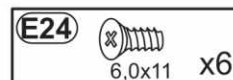
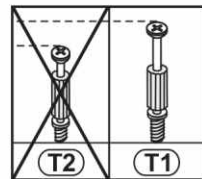
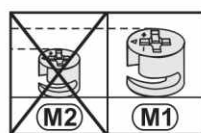
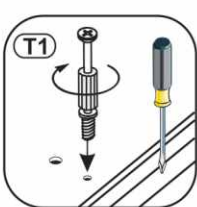
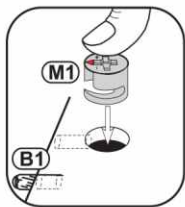

2

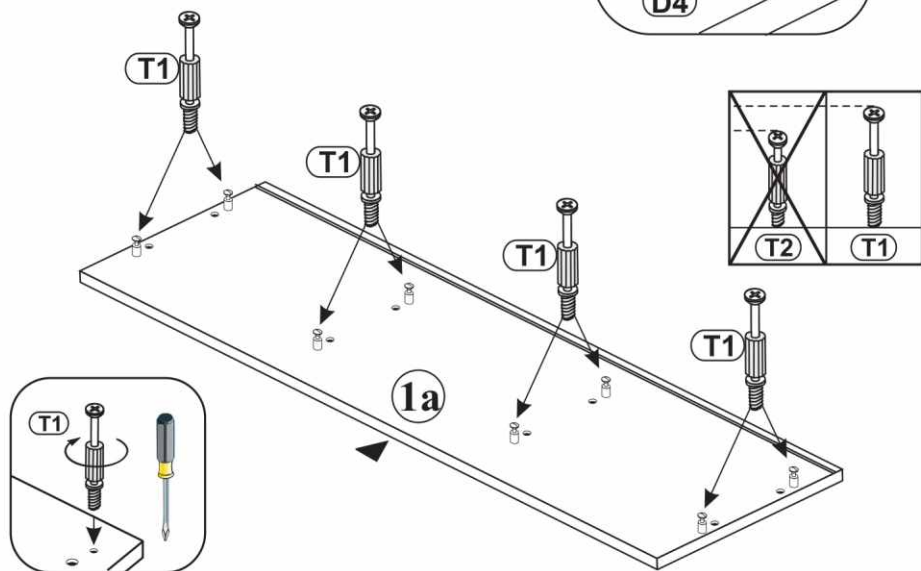
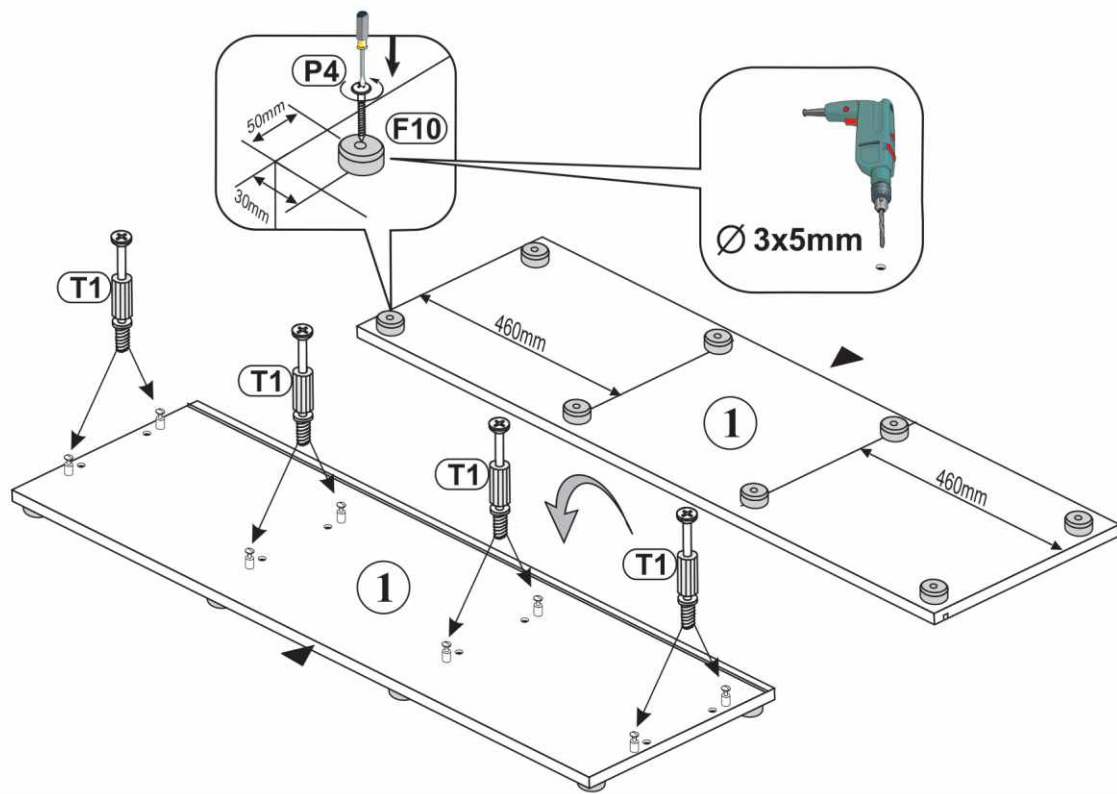
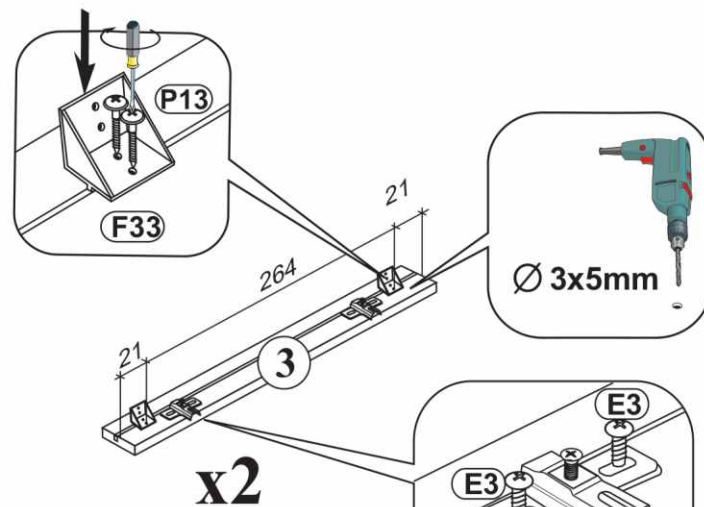
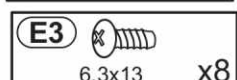
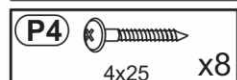
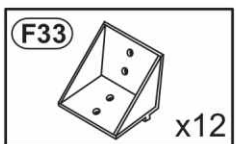
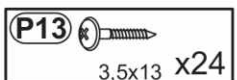
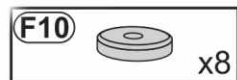
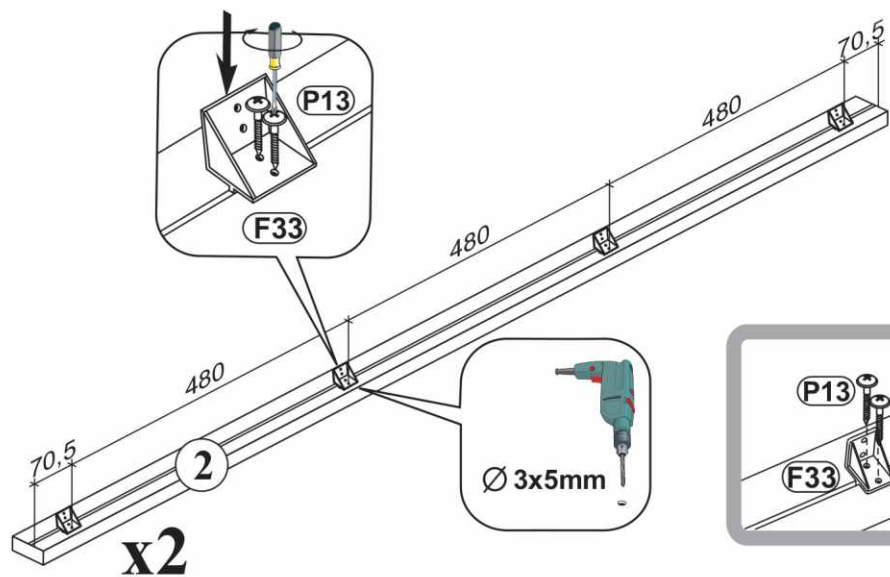

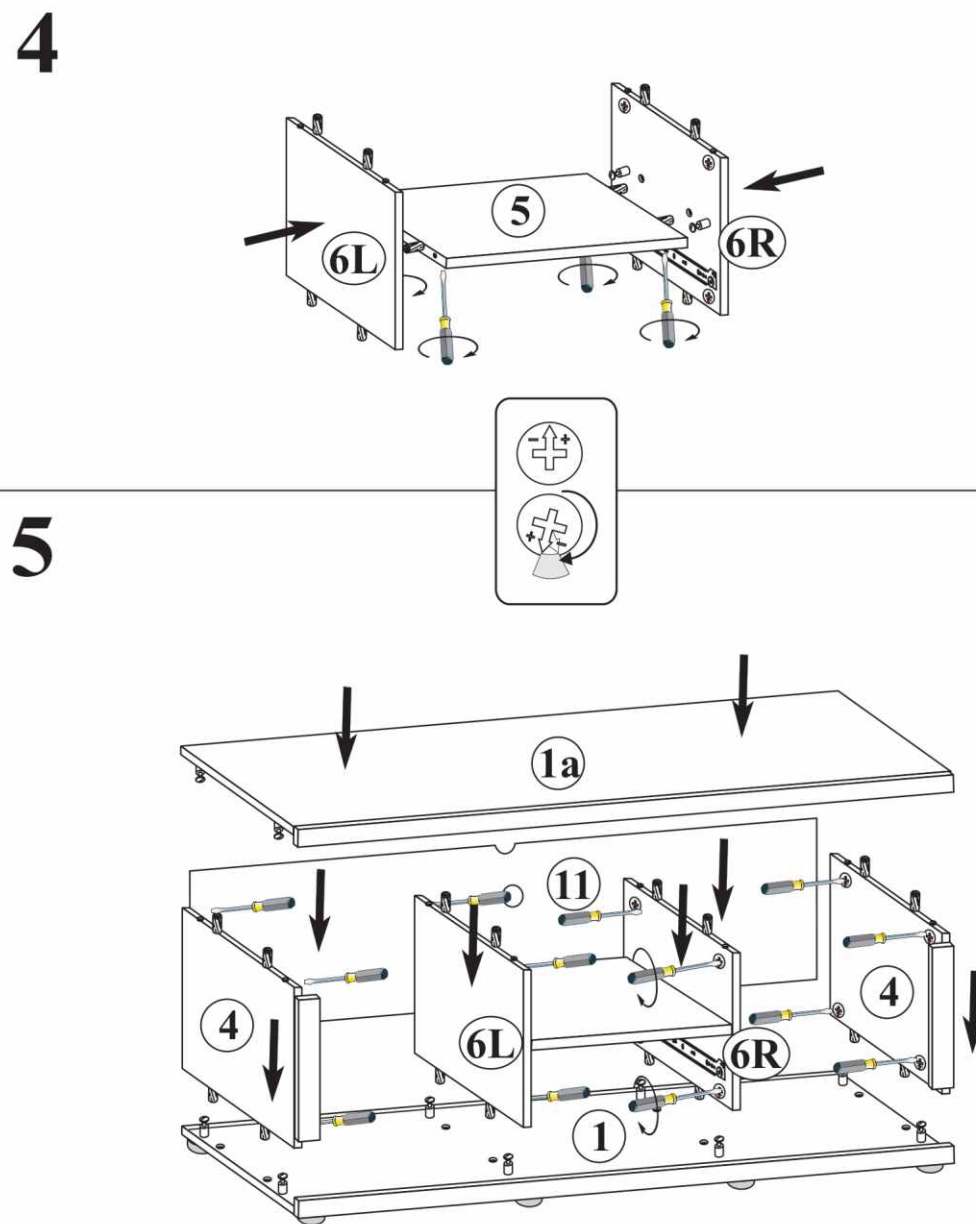
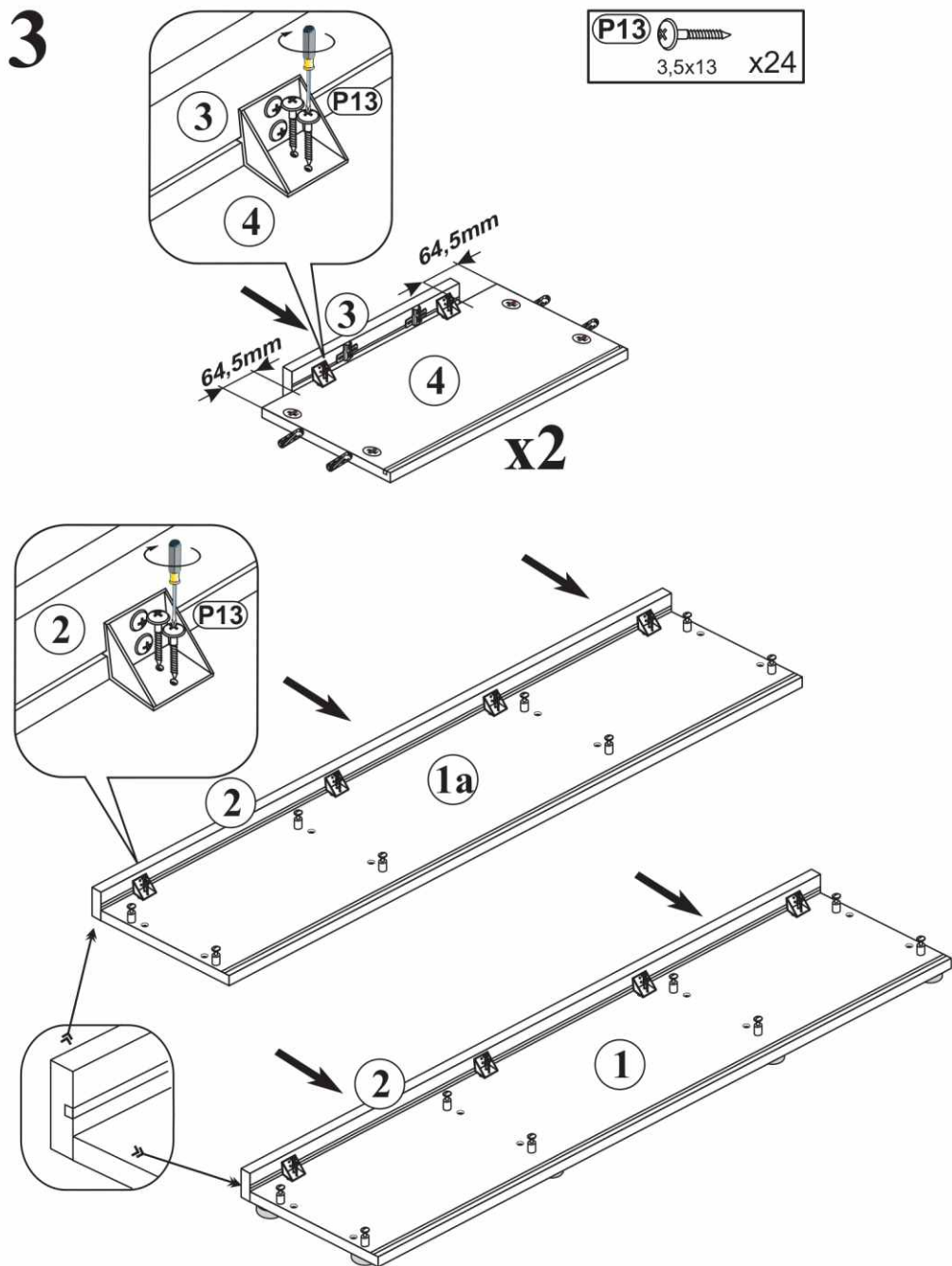

6

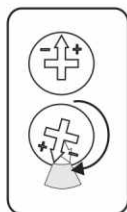
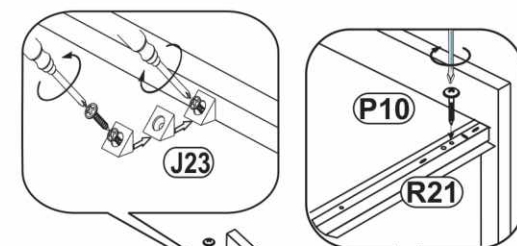
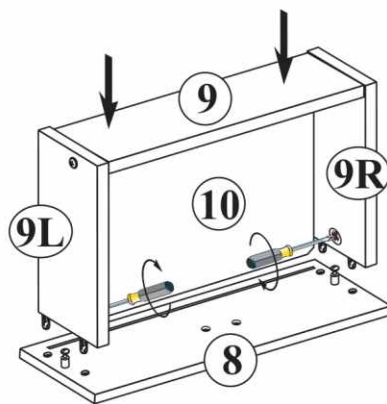
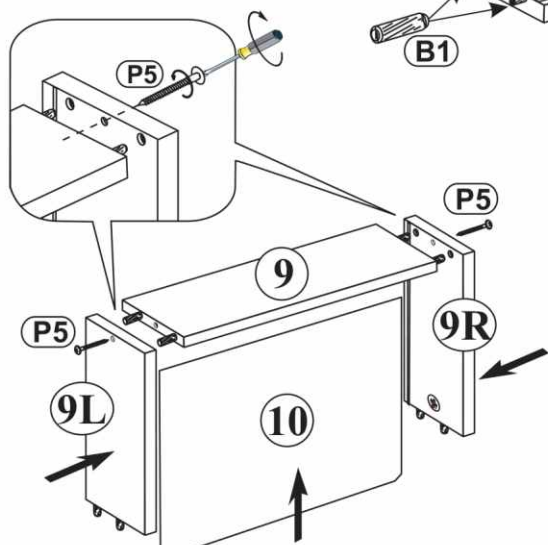
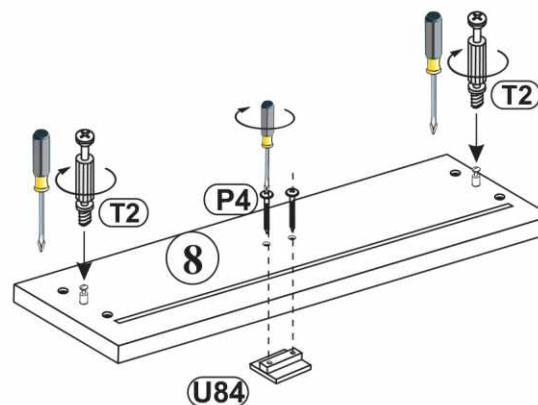
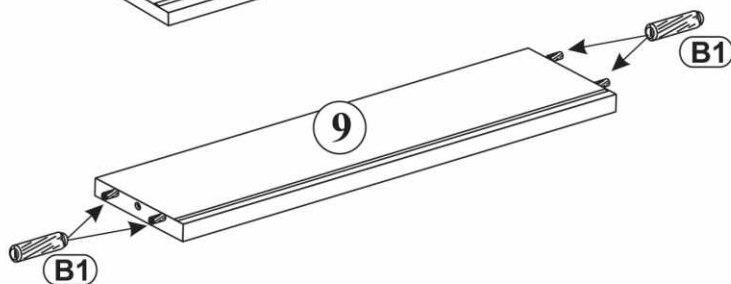
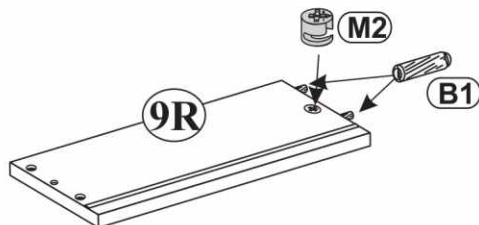
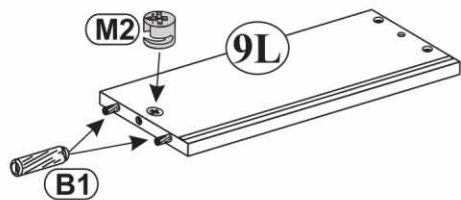
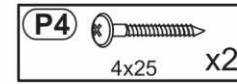
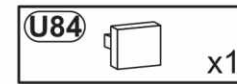
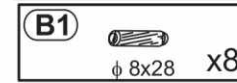
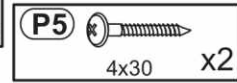
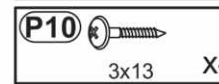
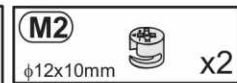
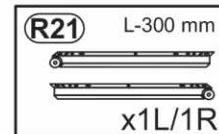
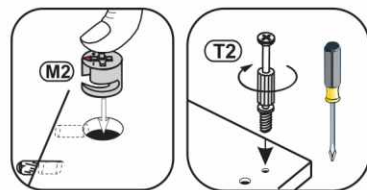
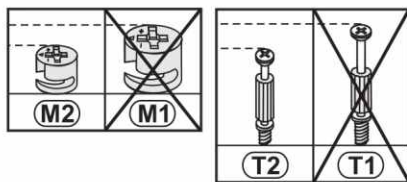

A=B ☺ ✓

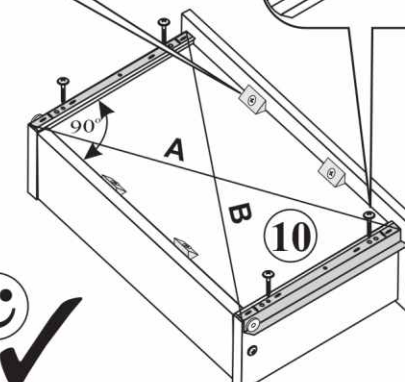

7

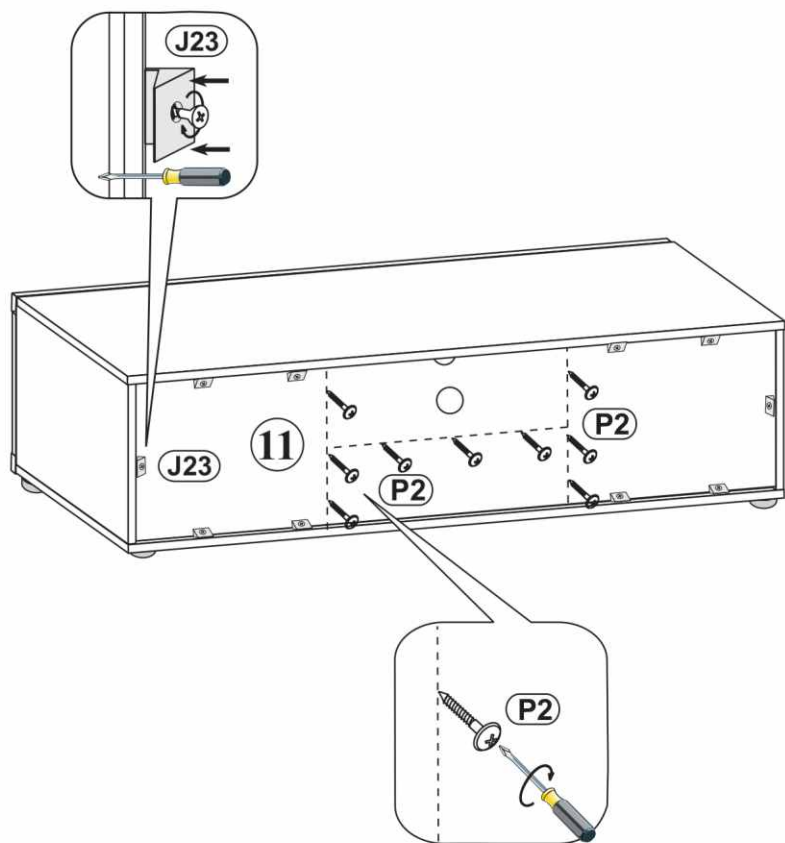

8

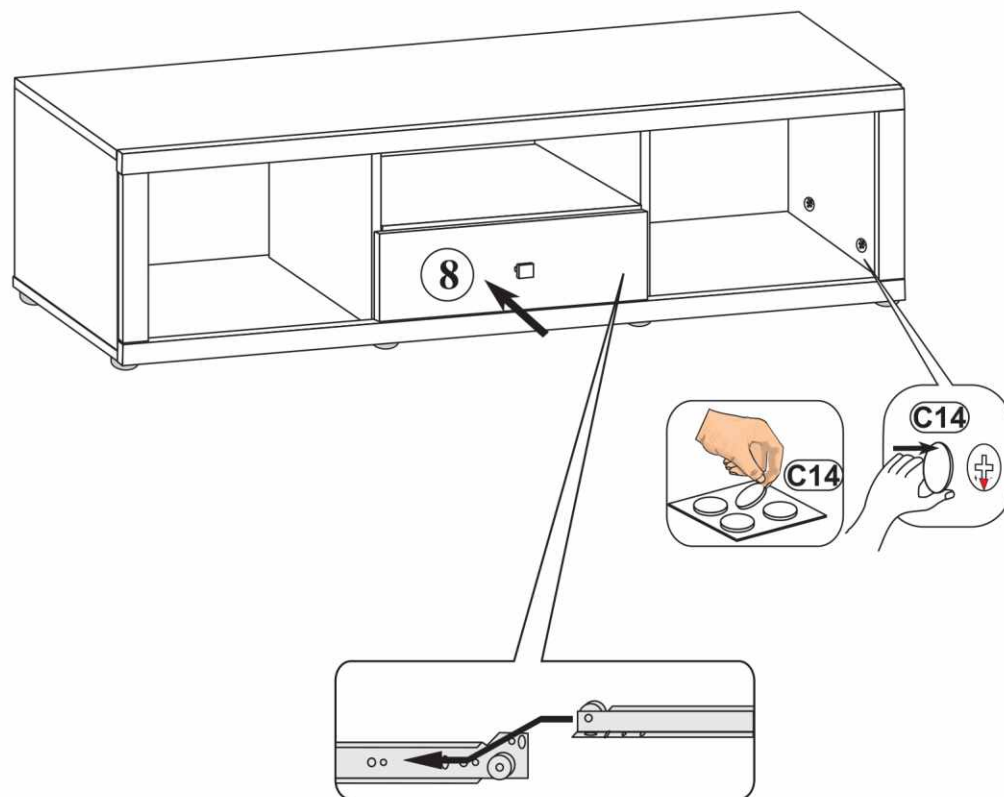
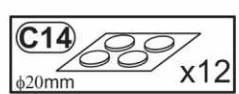

9

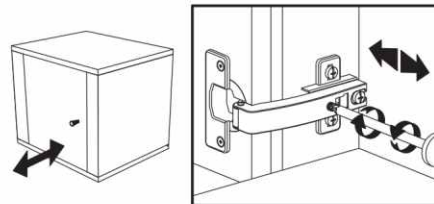
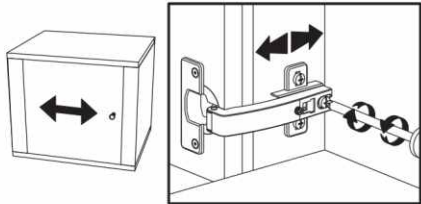
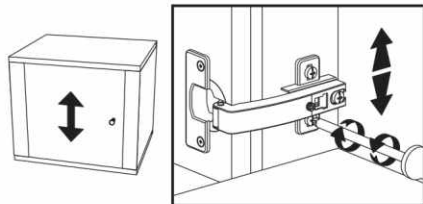
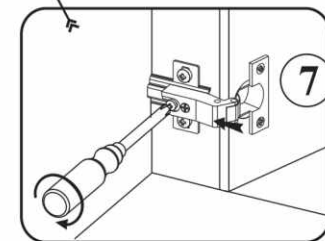
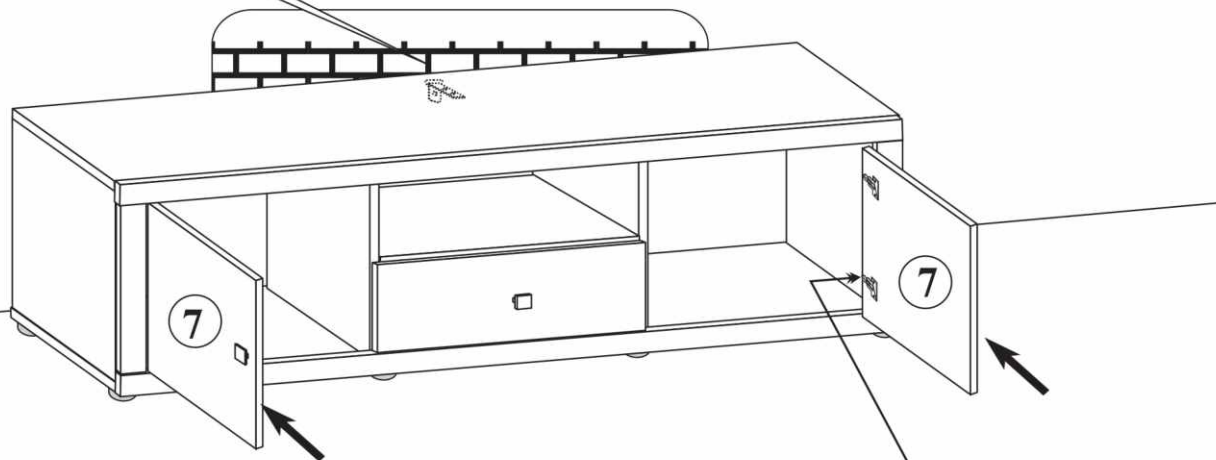
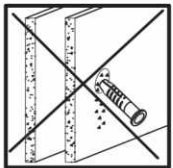
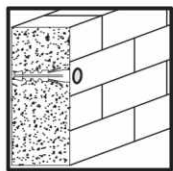
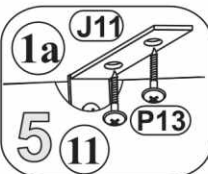
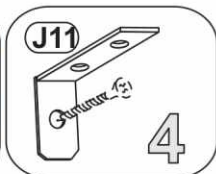
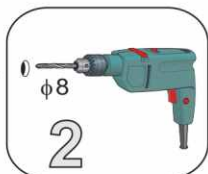
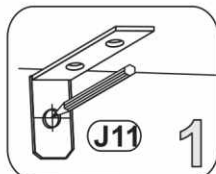
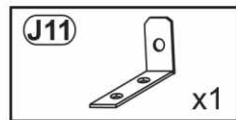
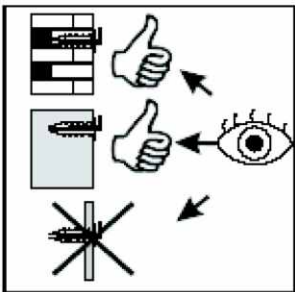

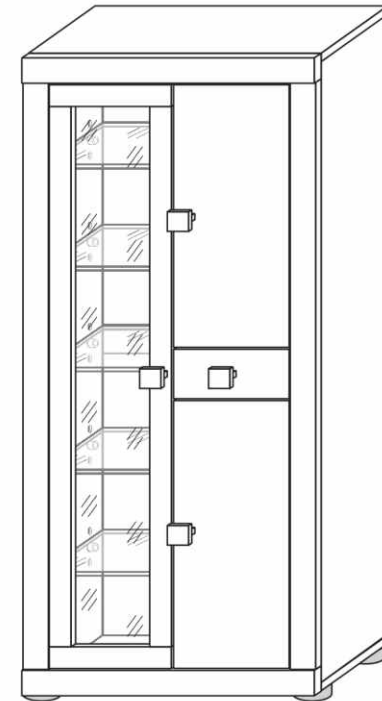
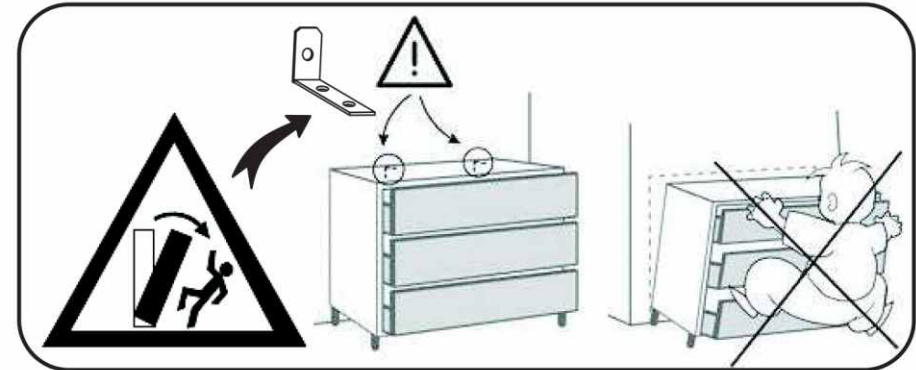
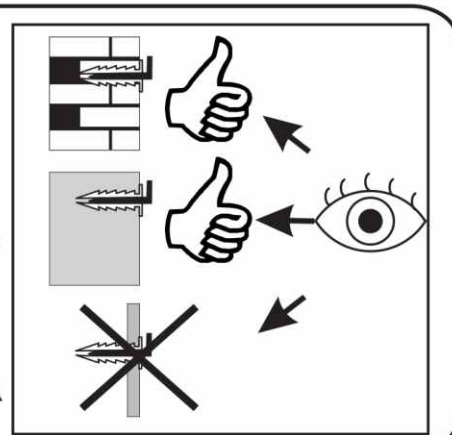
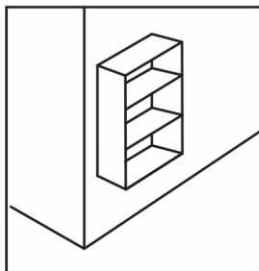
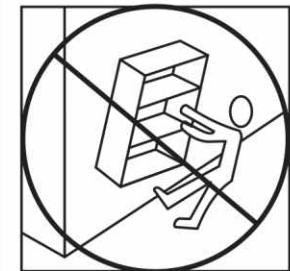
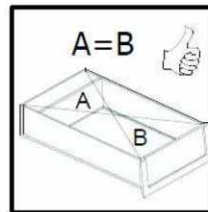
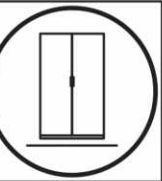
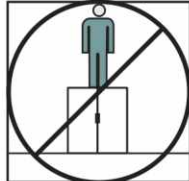
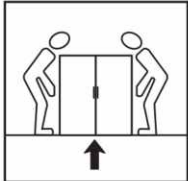
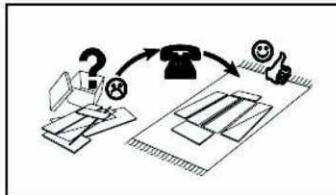
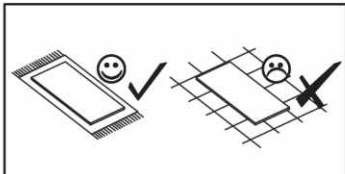
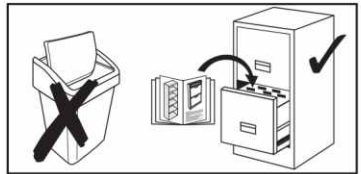
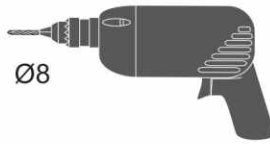
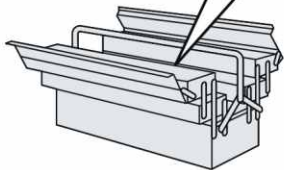
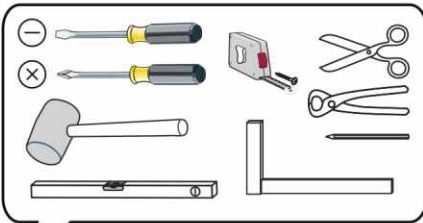
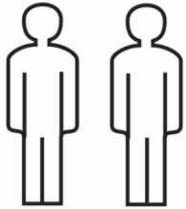

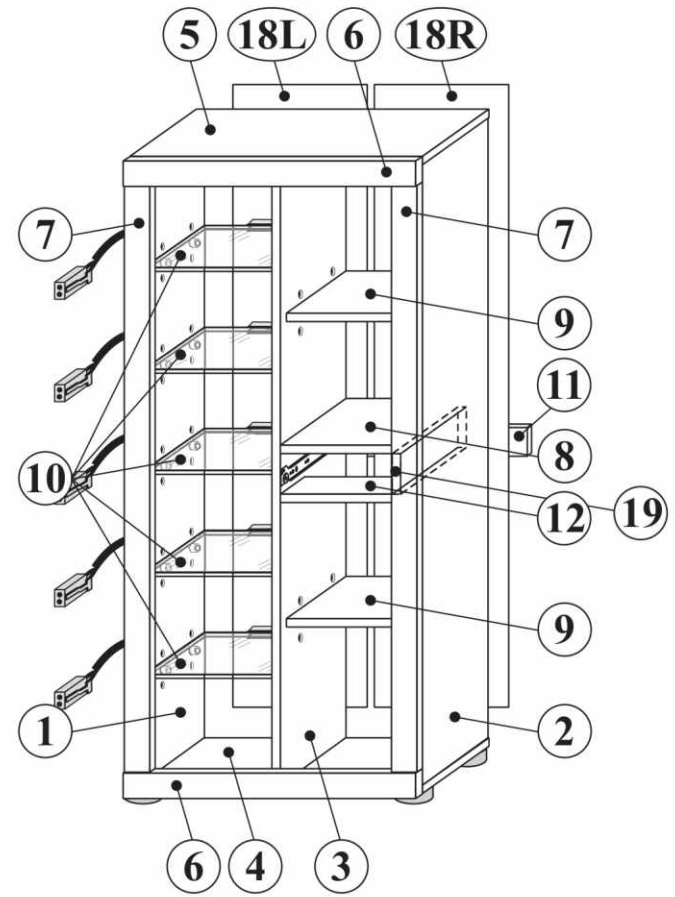
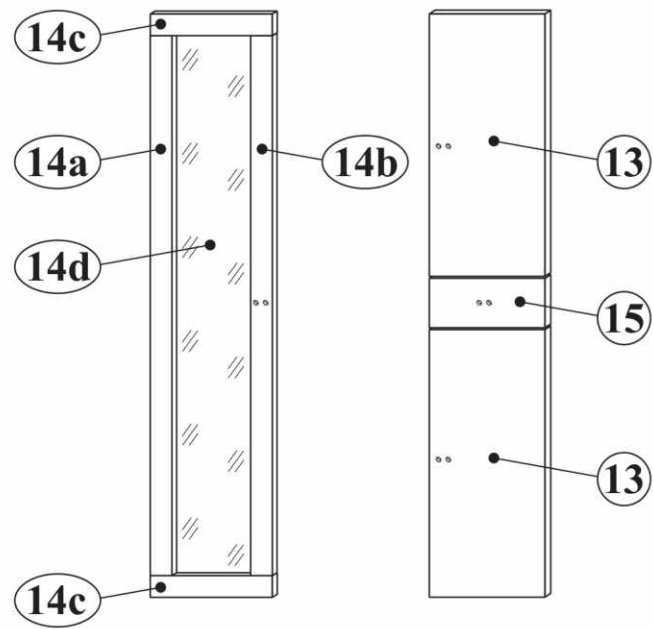
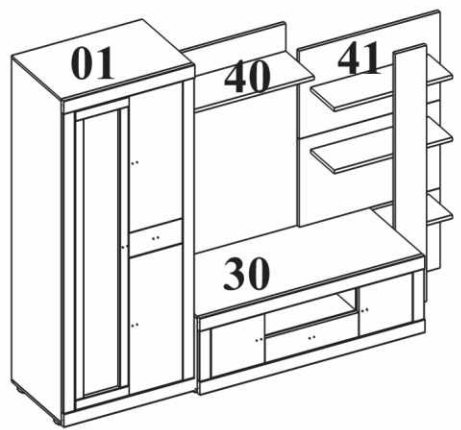

1,2	1950	350	2	2/4
3	1950	330	1	2/4
4,5	920	350	2	1/4
6	921	80	2	1/4
7	1821	80	2	2/4
8	436,5	329	1	1/4
9	436	320	2	1/4
10	436	310	5	1/4
11	888	100	1	1/4
12	436,5	100	1	1/4
13	830	375	2	1/4
14a,14b	1695	60	2	2/4
14c	375	60	2	1/4
14d	1725	285	1	2/4
15	375	149	1	1/4
16L,16R	302	100	2	1/4
16	314	100	1	1/4
17	325	300	1	1/4
18L,18R	1959	448	2	2/4
19	140	329	1	1/4

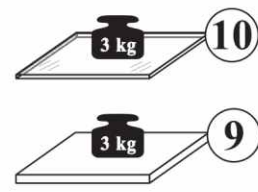
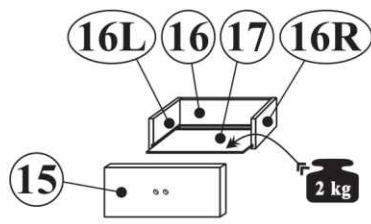

NR 1

B1 φ 8x28mm x31	C14 φ20mm x20
M1 φ15x12mm x30	G5 x16
T1 5x39mm x22	W2 x20
J23 x18	W1 x8
S6 3,0x20 x23	T12 L-48 x4
F1 x7	B22 φ 8x35 x4
F33 x16	K1 7x50 x1
P13 3,5x13 x64	

NR 2

R21 L-300 mm x1L/1R
E24 6x11 x6
S3 3,5x13 x2
P10 3x13mm x4

NR 3

U84 x4
P4 4x25 x8

NR 4

M2 φ12x10mm x2
T2 5x35mm x2
P5 4x30 x2

NR 5

J11 x1
P13 Ø3,5x13 mm x2
F10 x6
P4 4x25 x6

NR 6

SR φ 26 x8
D4 H-4 x8
E3 6,3x13 x16
S8 4x13 x16

NR 7

O20 x5
O21 MAX 3,6 W x1





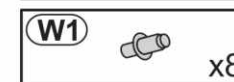
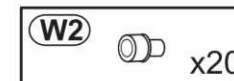
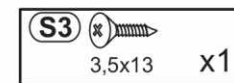
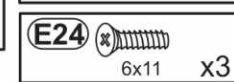
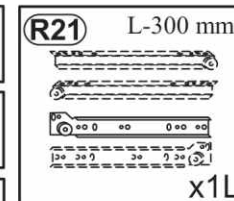
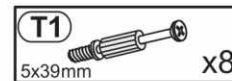
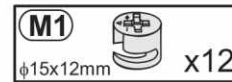
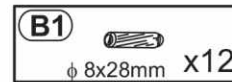
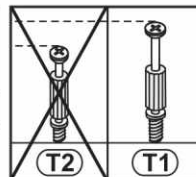
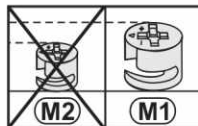
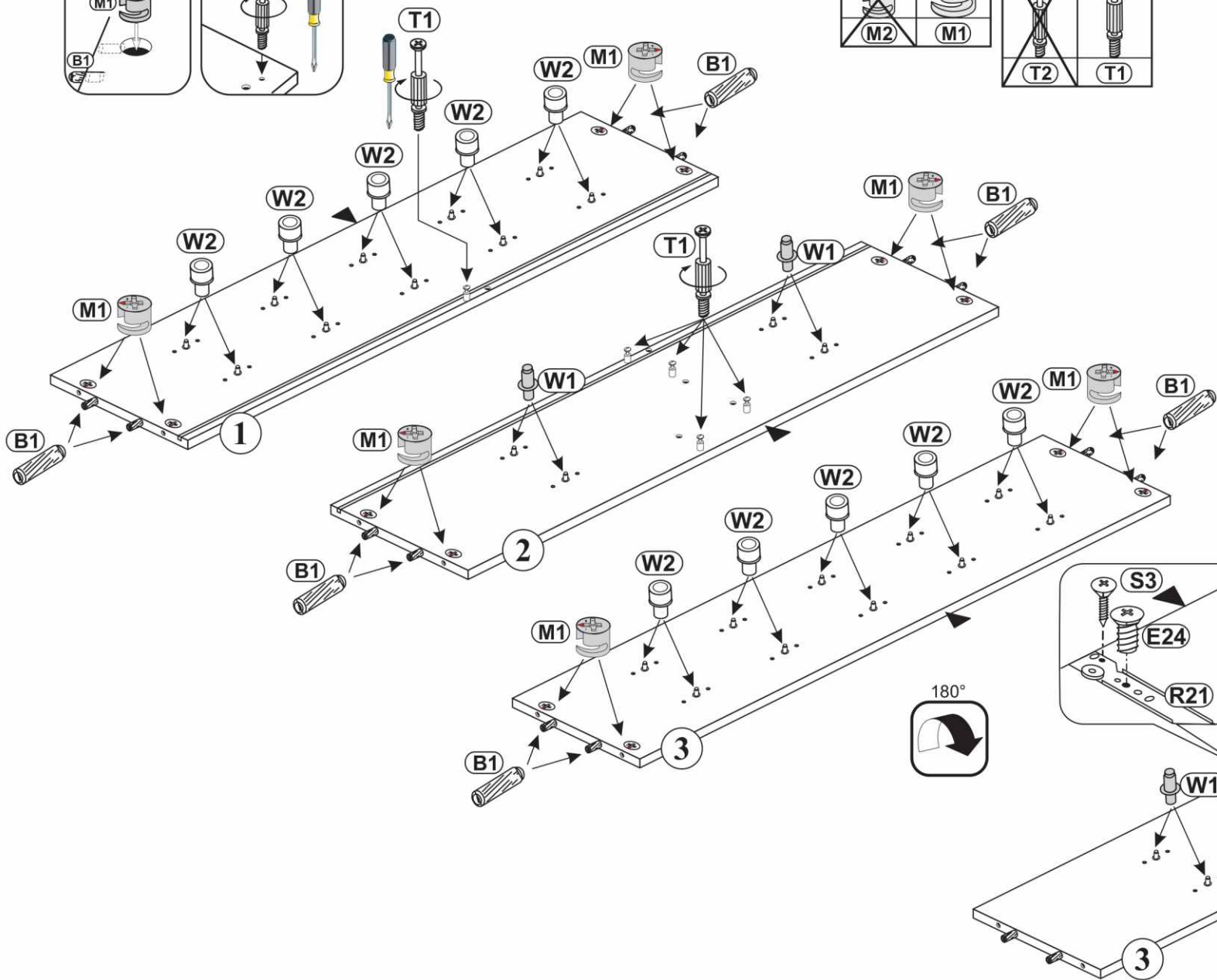
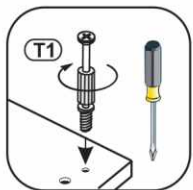
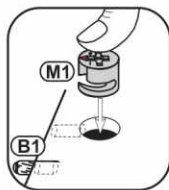

1

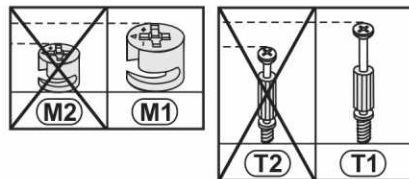
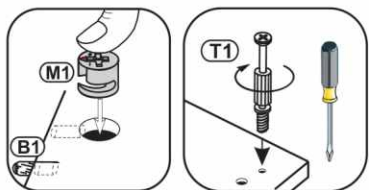

2



- | | | | |
|------------|---|-----------|--|
| F10 |  x6 | B1 |  x6
φ 8x28mm |
| P4 |  4x25 x6 | M1 |  x6
φ15x12mm |
| | | T1 |  x14
5x39mm |

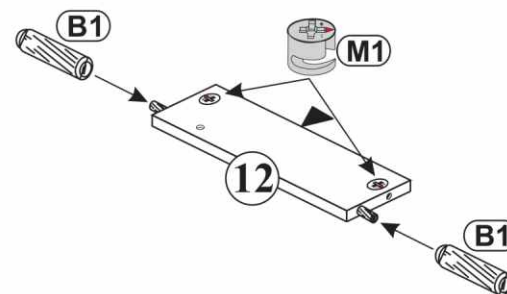
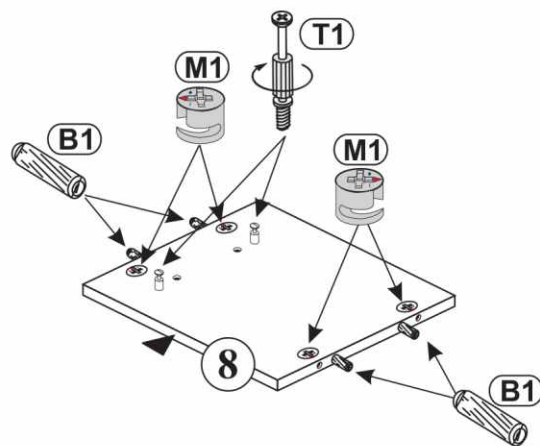
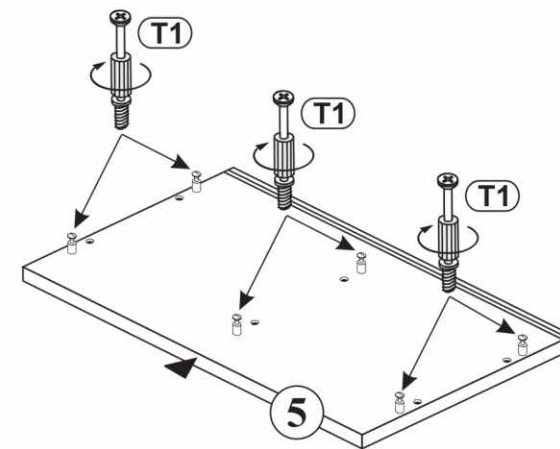
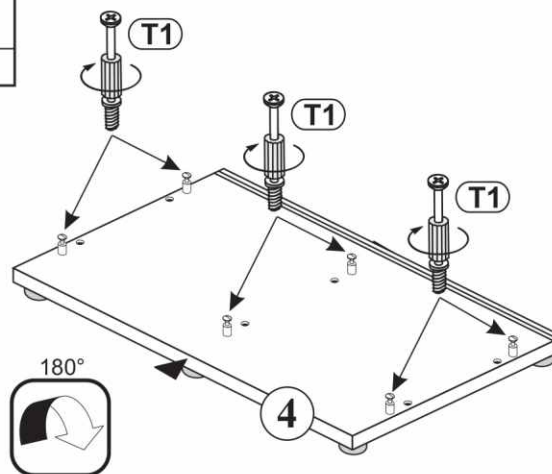
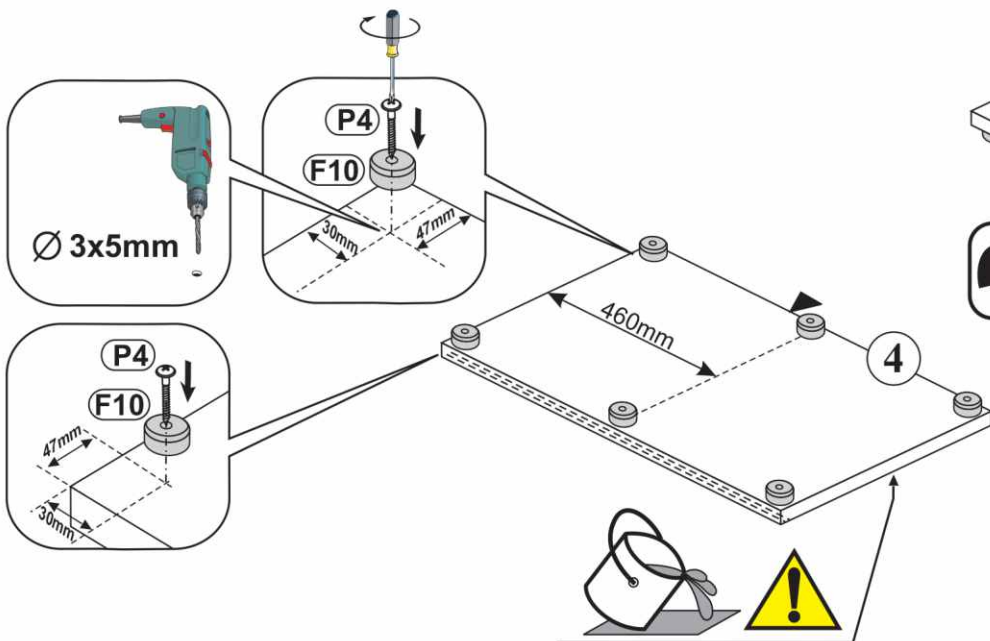

3

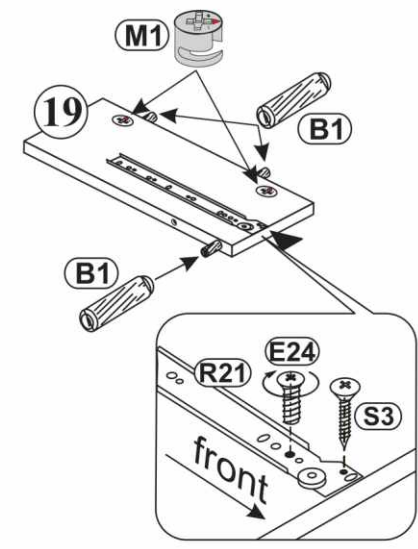
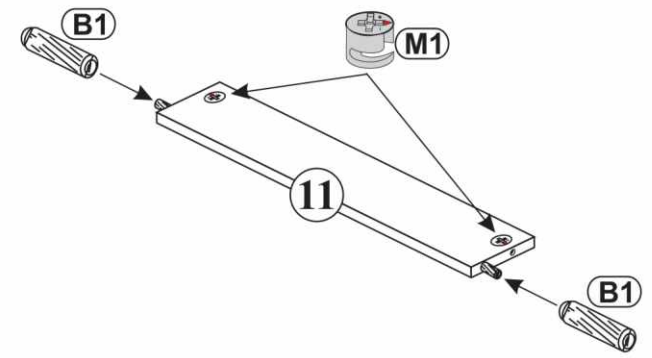
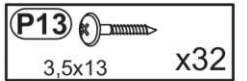
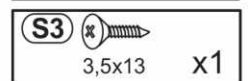
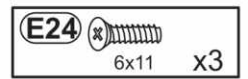
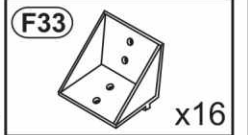
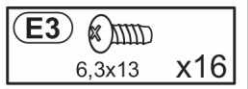
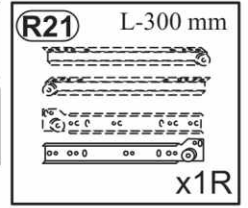
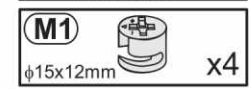
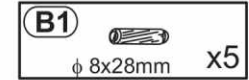
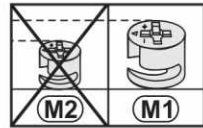
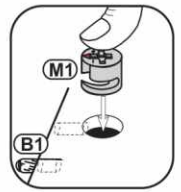
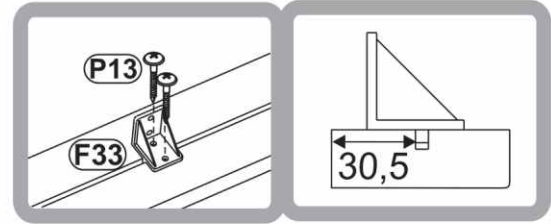
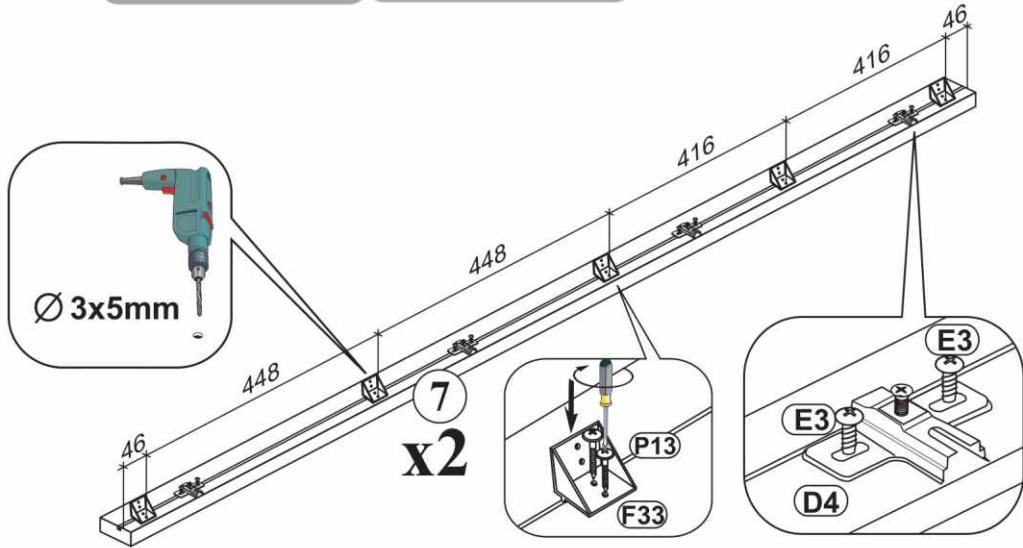
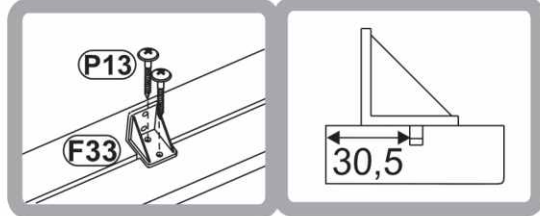
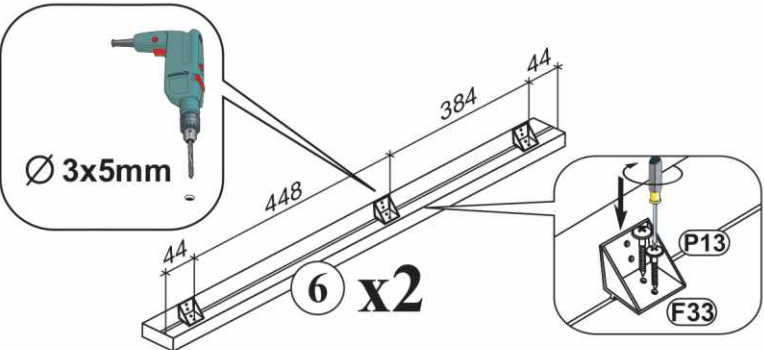

4

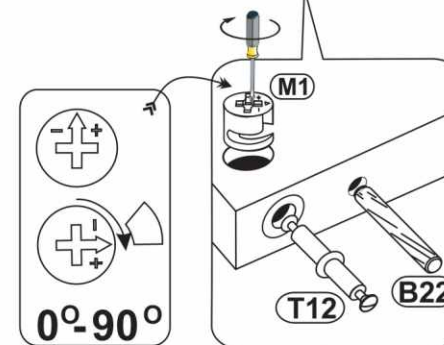
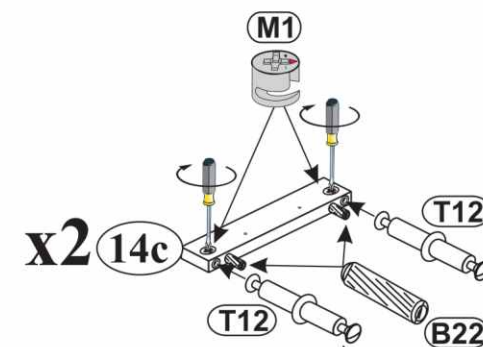
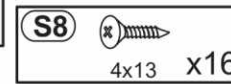
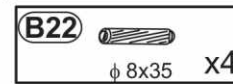
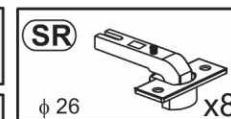
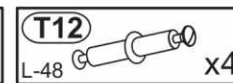
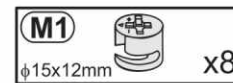
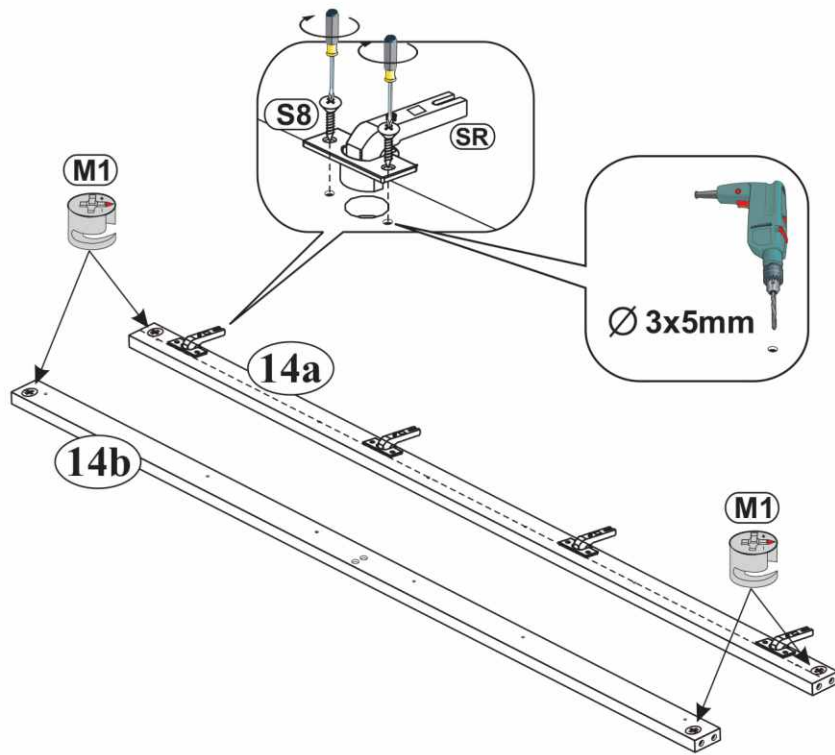
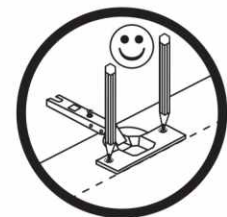
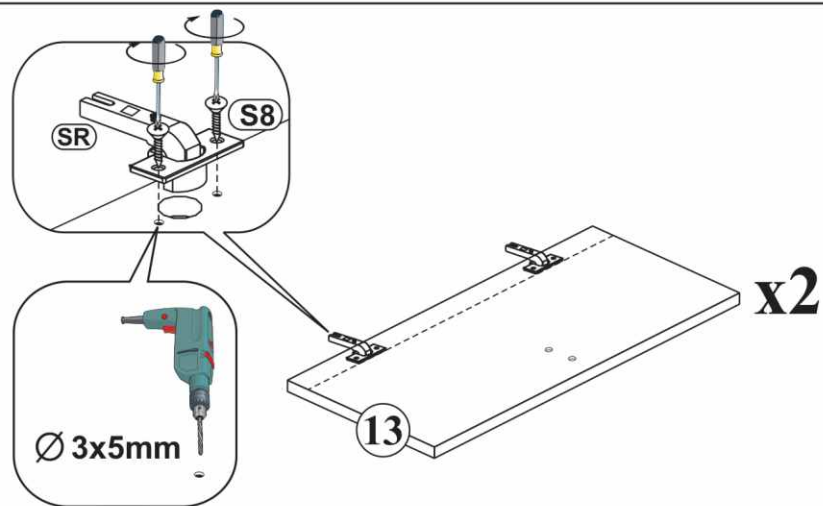

5

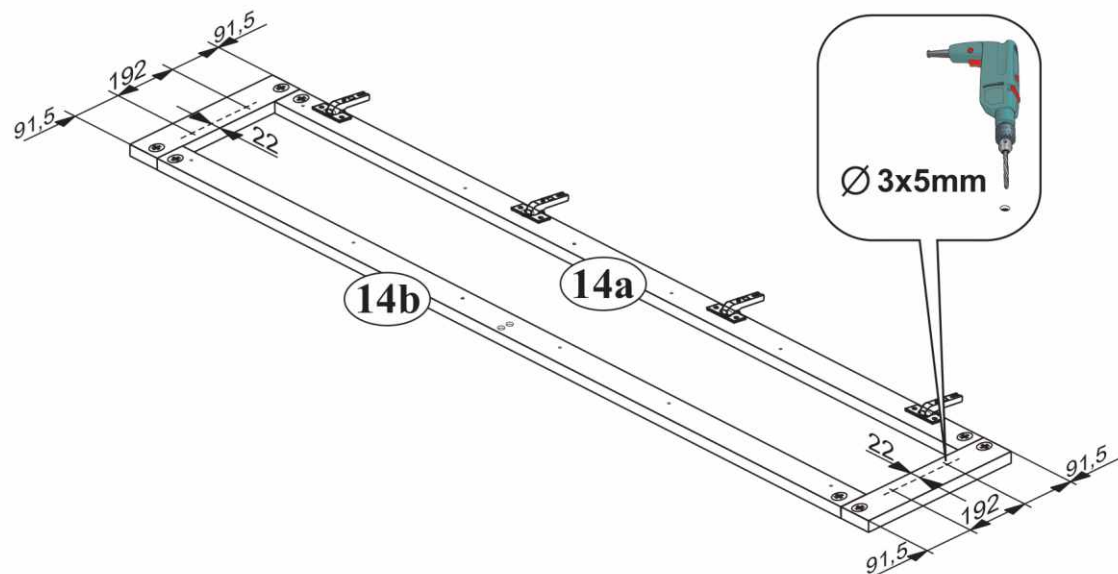
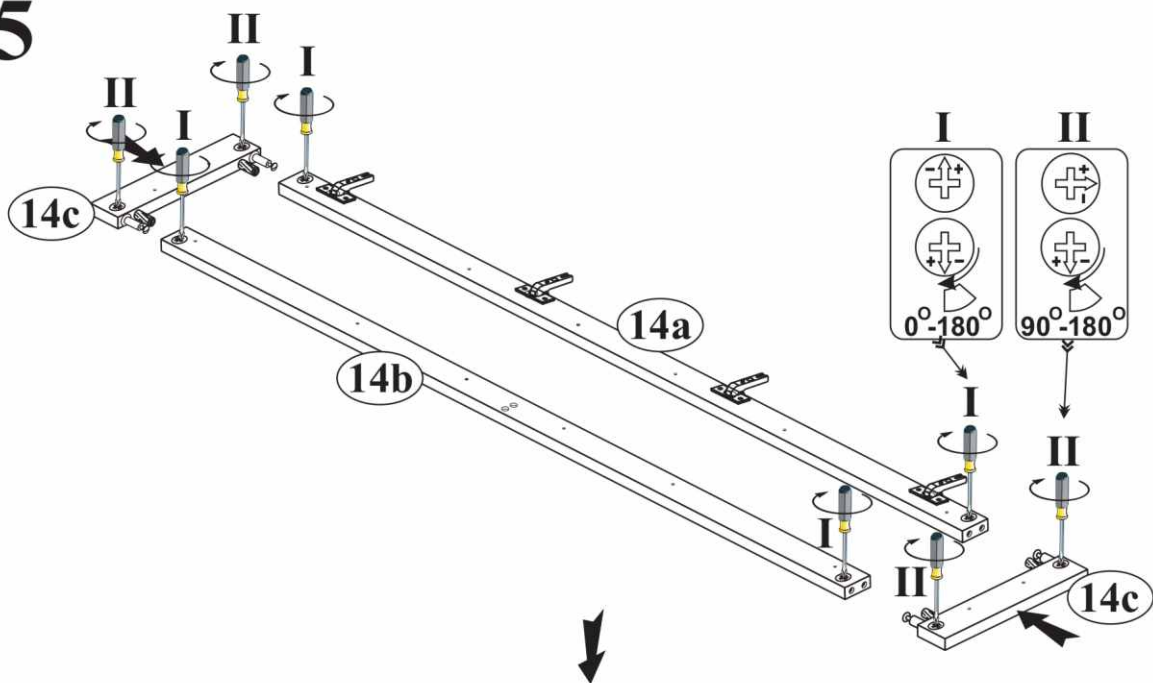

6

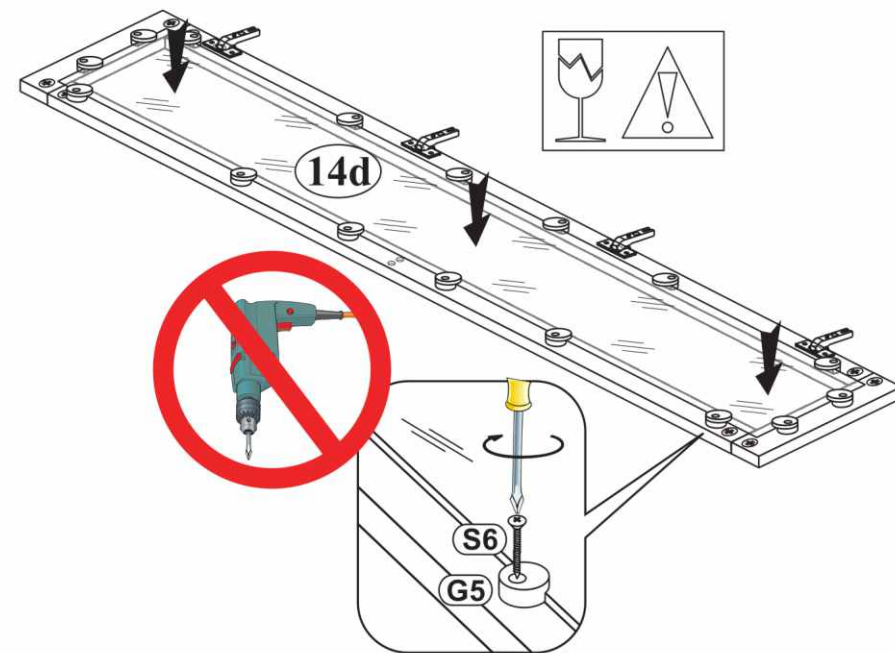

S6 3,0x20 x16

G5 x16

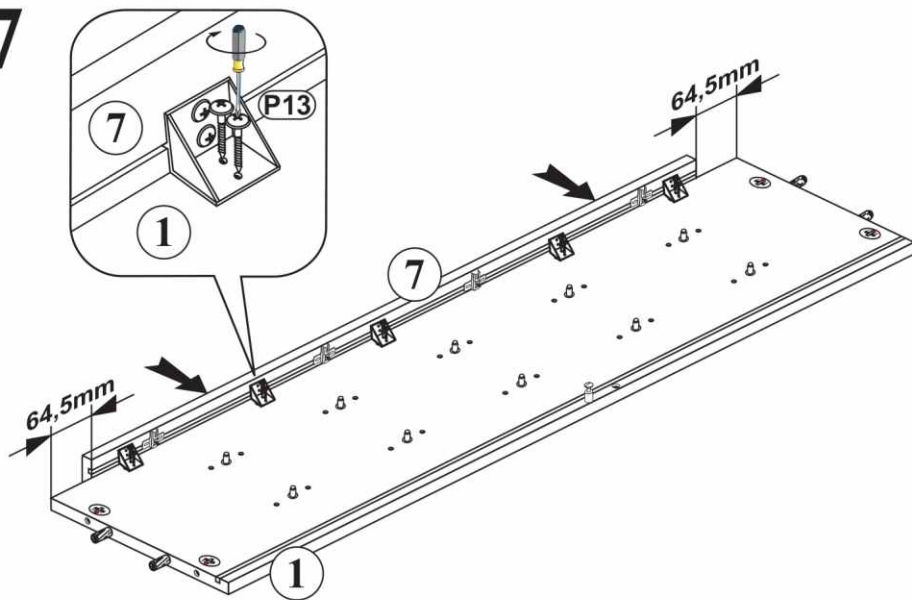

7



- (P13)**  3,5x13 x32
- (K1)**  7x50 x1

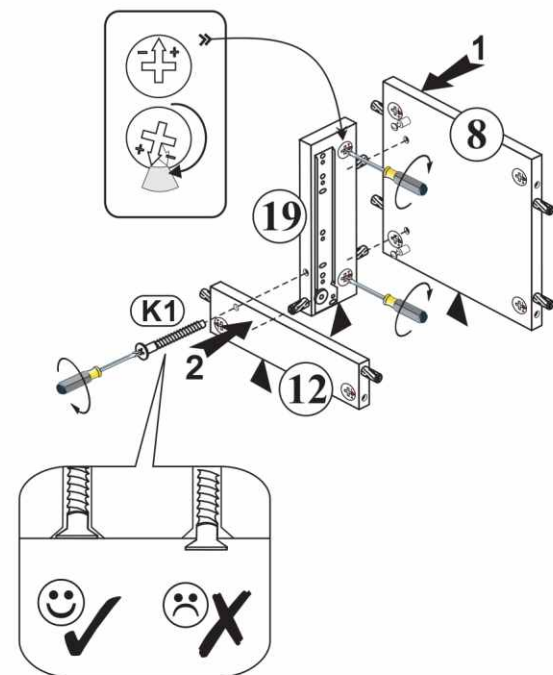
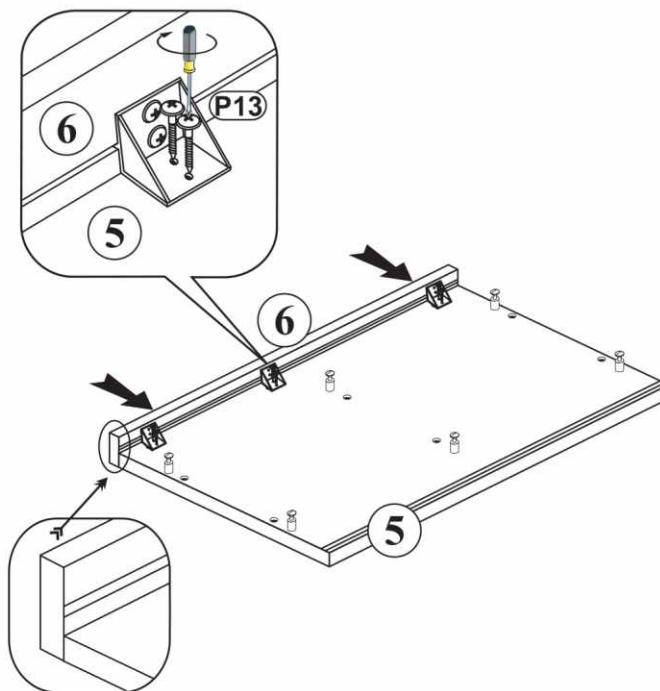
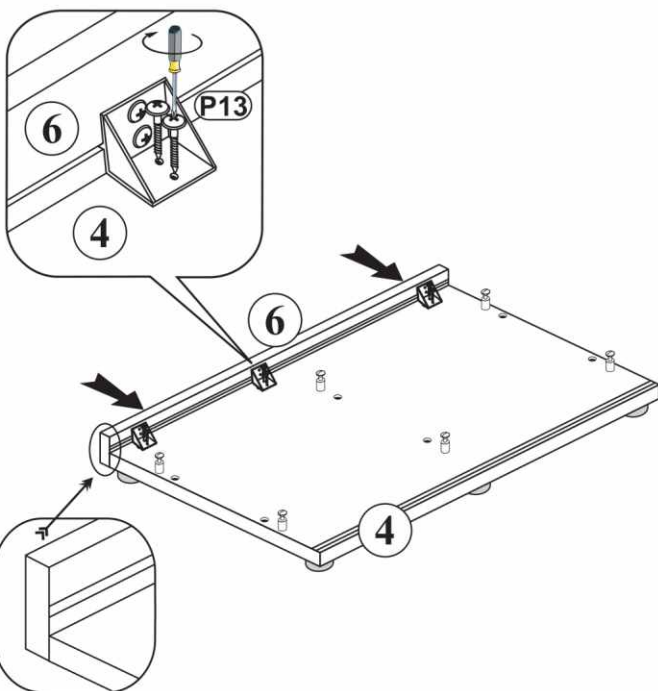
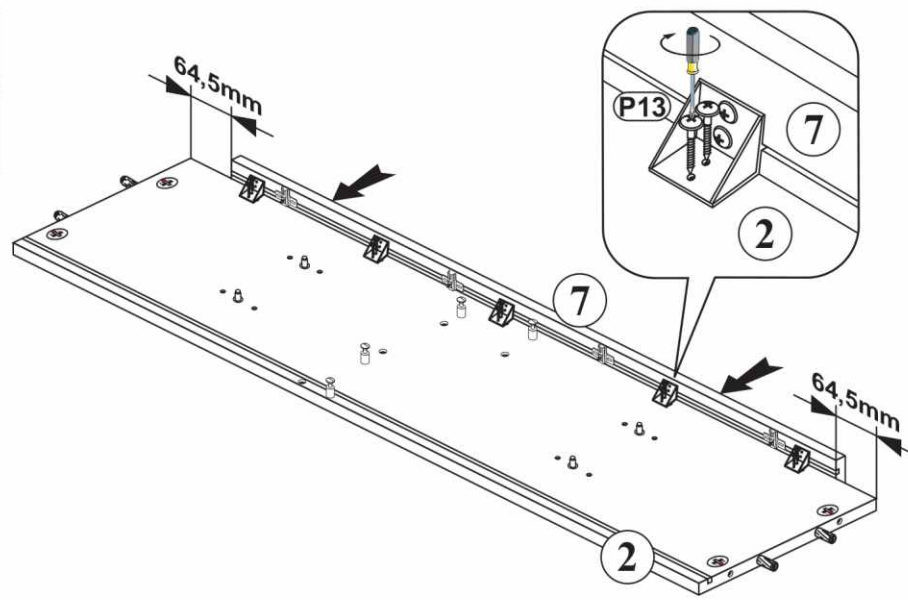

8

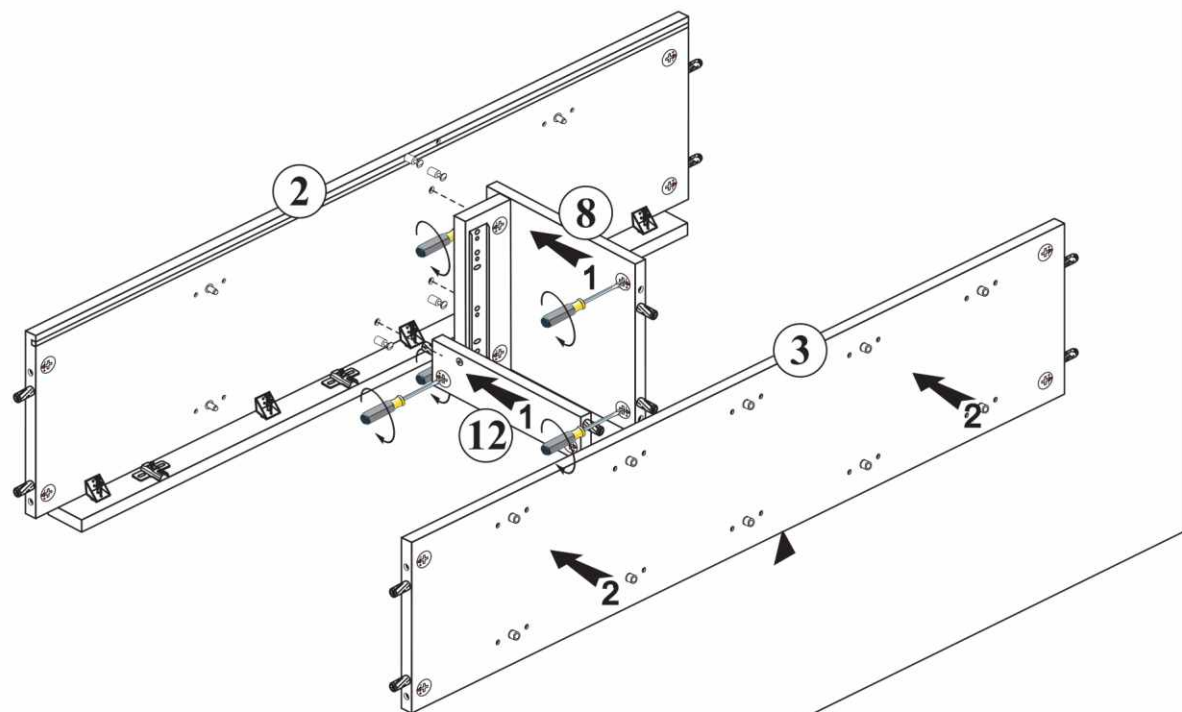

9

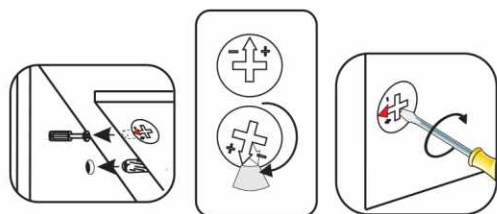
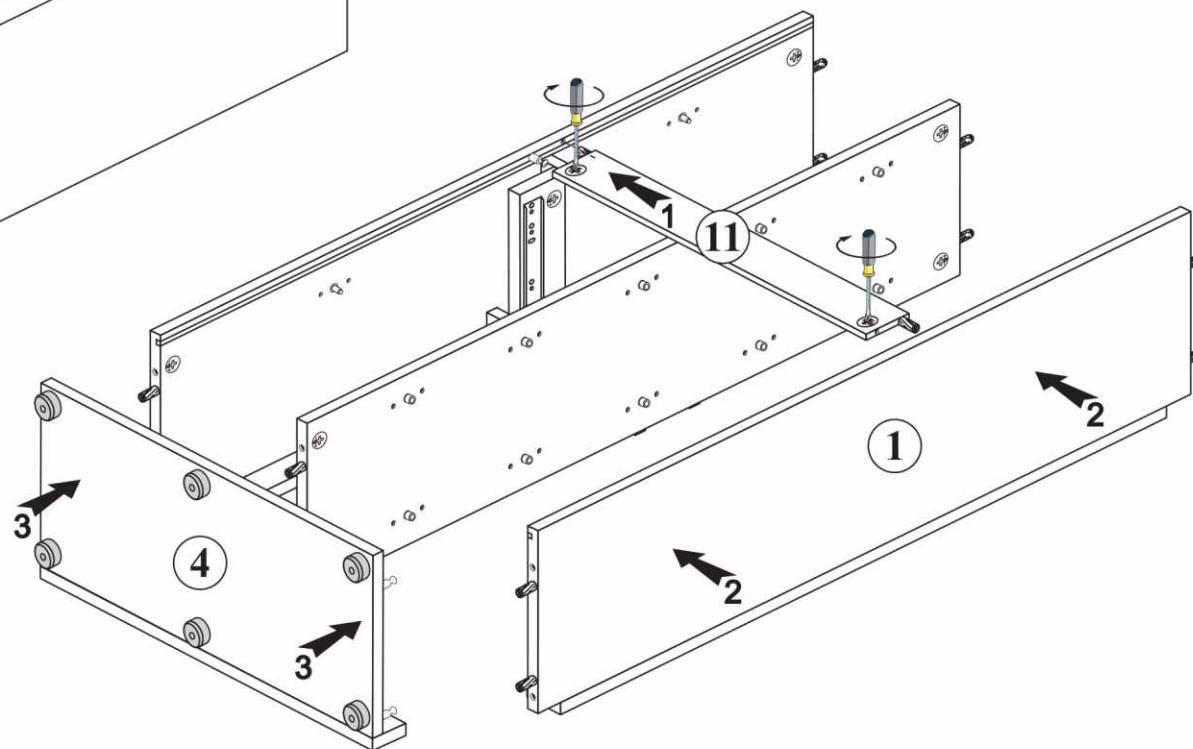
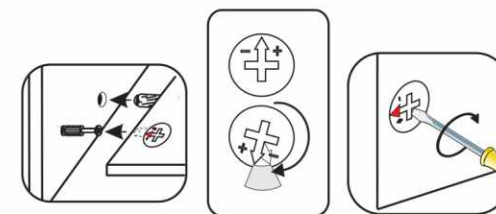

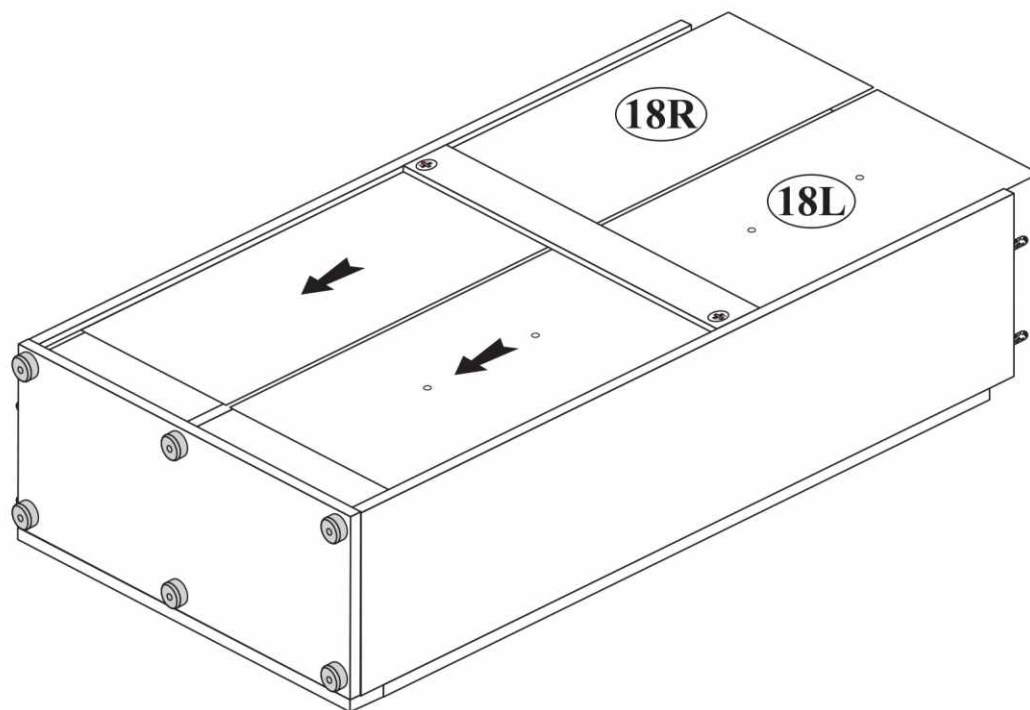

10

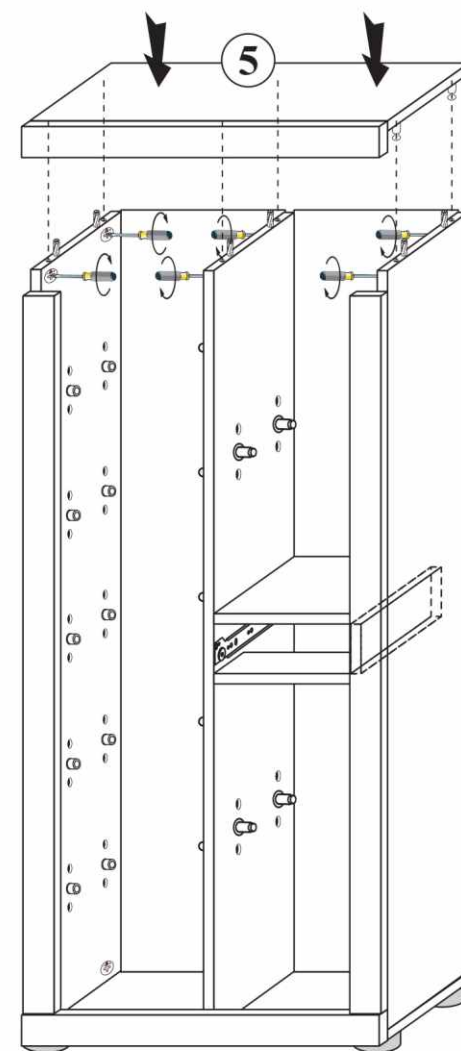
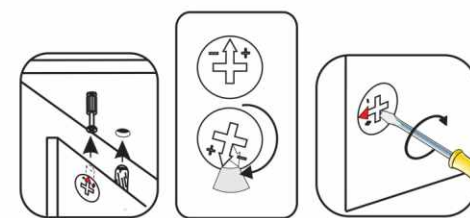

11



12

(F1)  x7
(S6)  3,0x20 x7
(J23)  x18

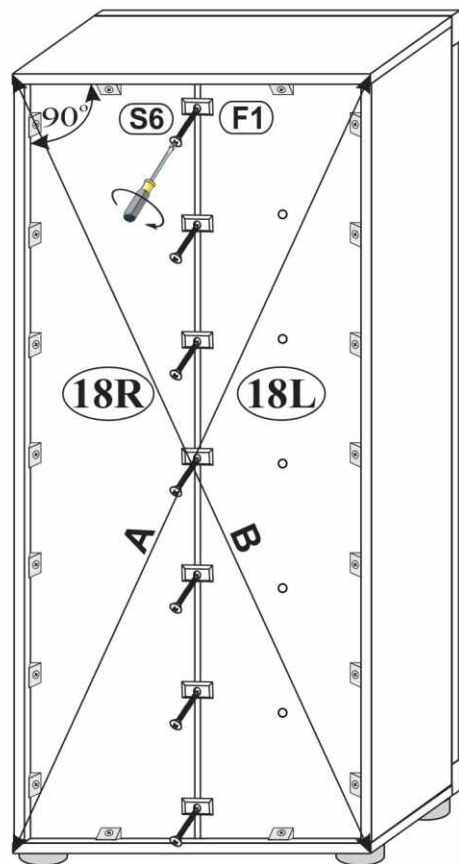

A=B 😊 ✓



1

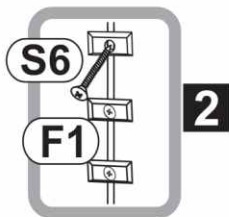

2

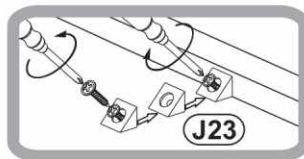

3

13

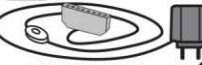
(O20)  x5
(O21)  MAX 3,6 W x1

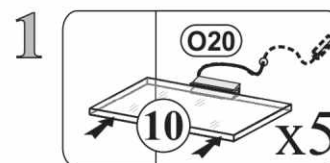

1

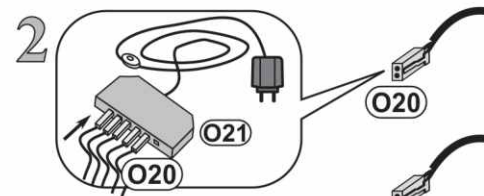

2

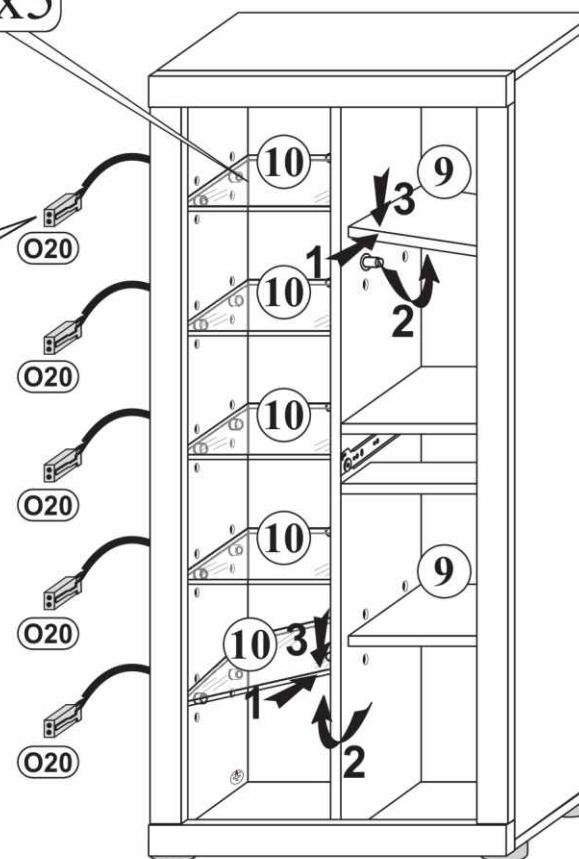

14

P13  3,5x13 x2

J11  x1

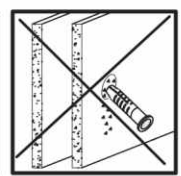
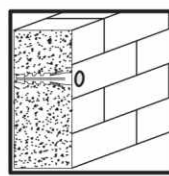
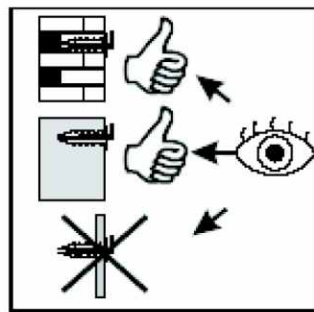
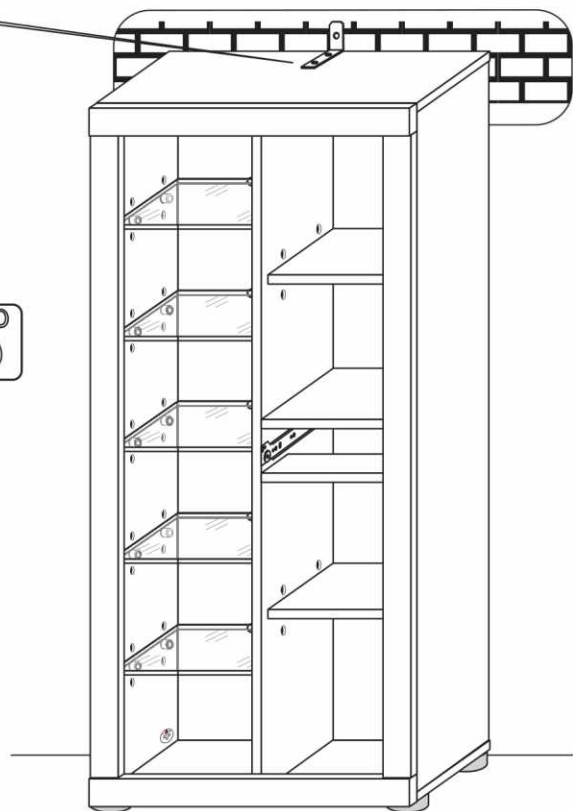

15

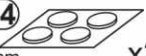
C14  φ20mm x20

P4  4x25 x6

U84  x3

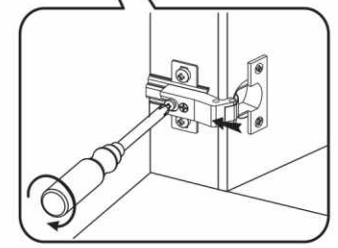
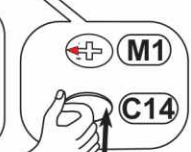
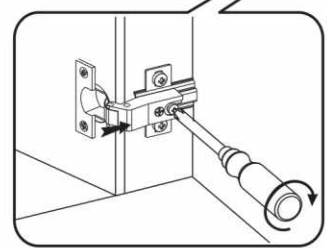
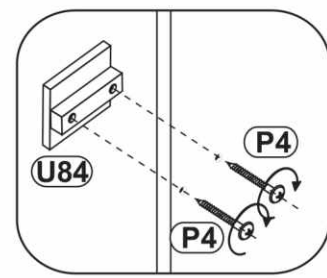
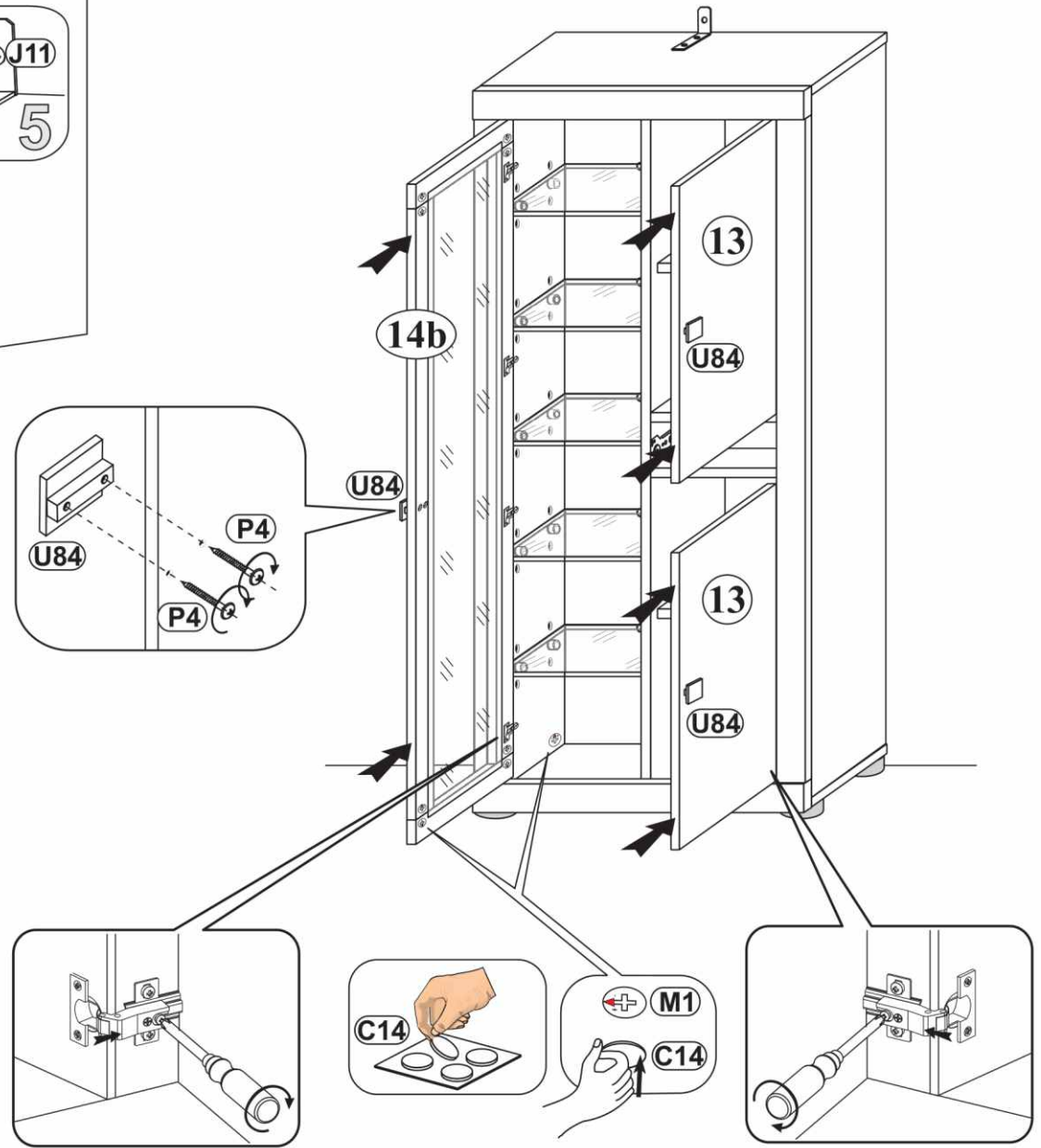

16

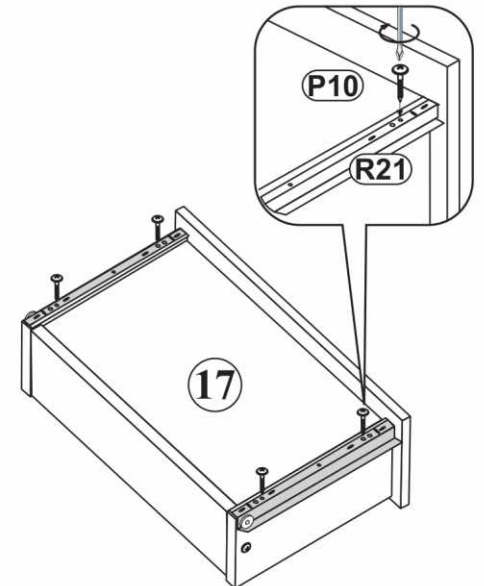
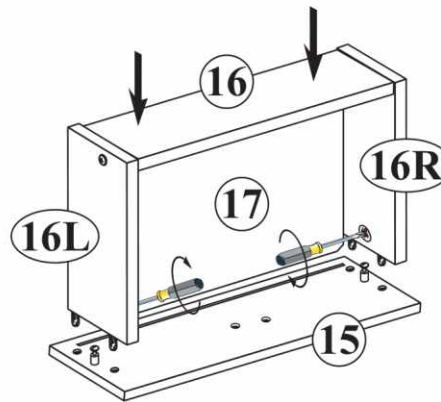
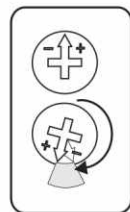
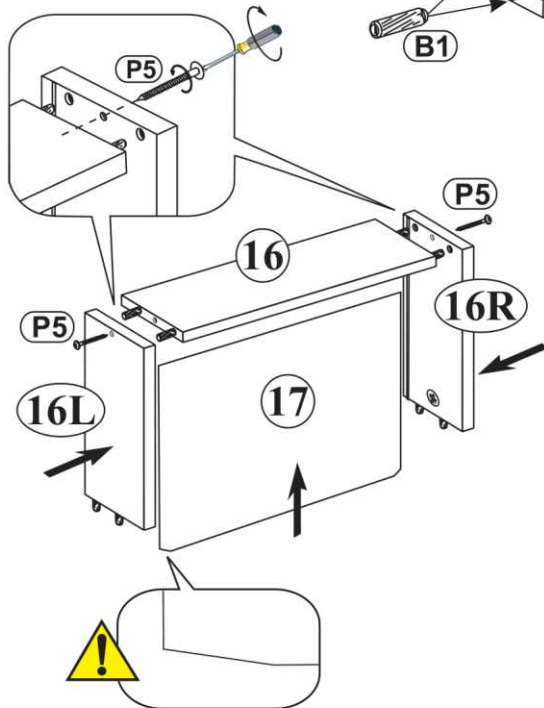
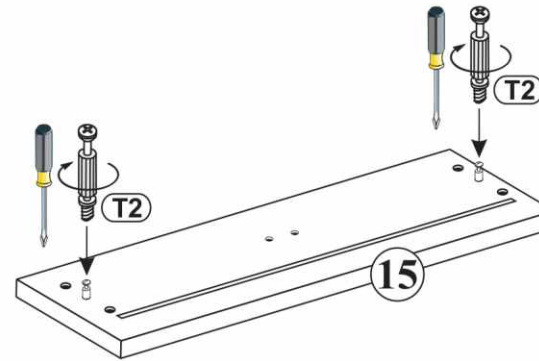
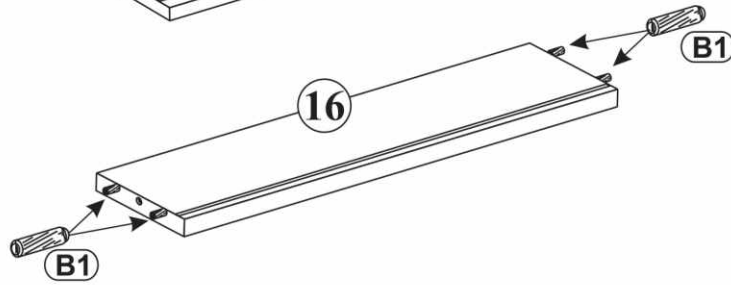
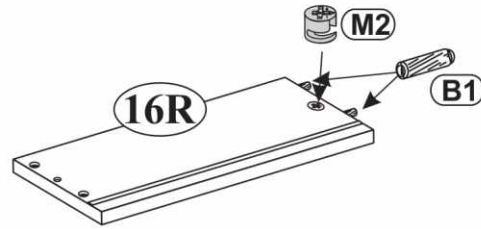
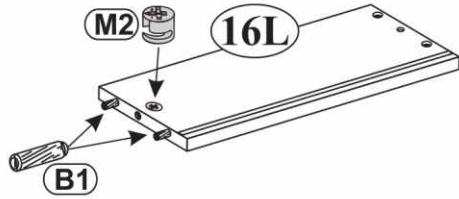
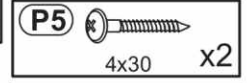
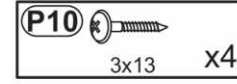
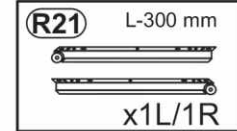
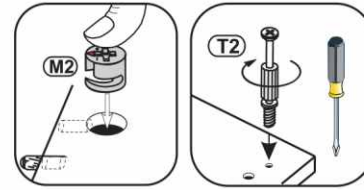
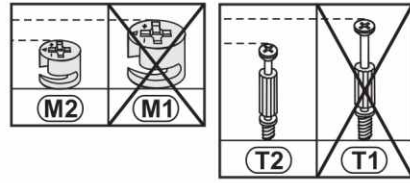

17

P4  4x25 x2	U84  x1
---	---

