











<b>A0</b>	<b>B2</b>	<b>C2</b>	<b>C7</b>	<b>D22</b>	<b>E3</b>	<b>K</b>	<b>P1</b>	<b>U0</b>
								
∅8x30	∅7x70		16mm	5x11	10x50	4mm		
<b>x4</b>	<b>x9</b>	<b>x4</b>	<b>x4</b>	<b>x4</b>	<b>x2</b>	<b>x1</b>	<b>x2</b>	<b>x2</b>

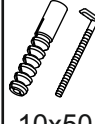

①	200	956	16	x1	1/1
②	160	1154	16	x1	1/1
③	200	100	16	x1	1/1
④	200	100	16	x1	1/1
					1/1

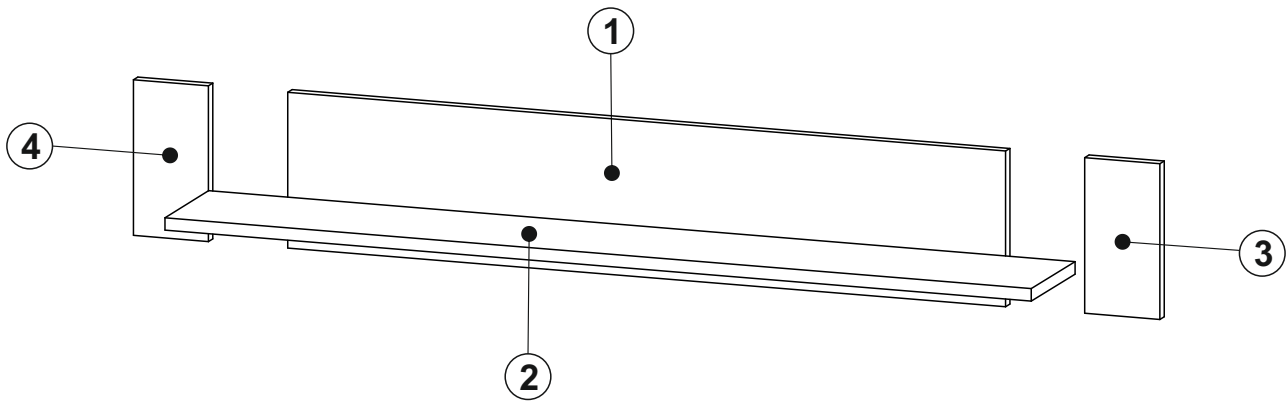

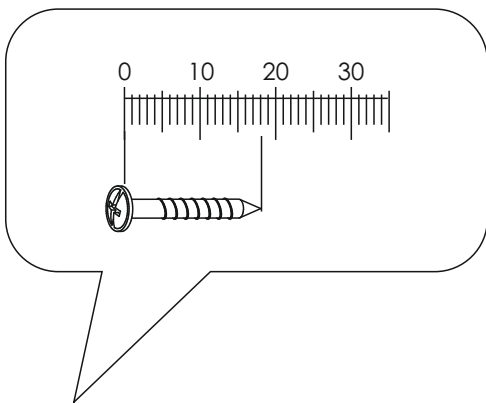
# 1

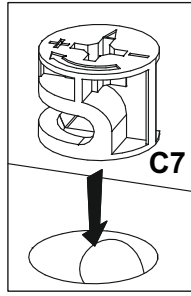
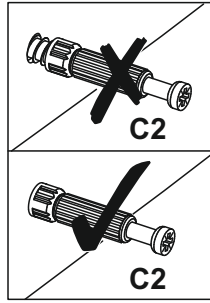
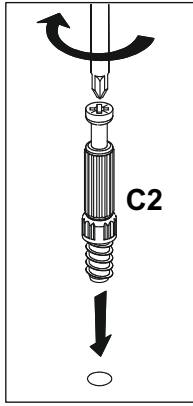

<b>A0</b>	<b>C2</b>	<b>C7</b>	<b>P1</b>
∅8x30		16mm	
<b>x4</b>	<b>x4</b>	<b>x4</b>	<b>x2</b>

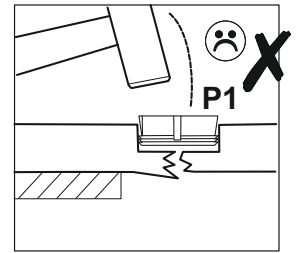
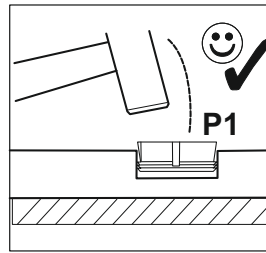
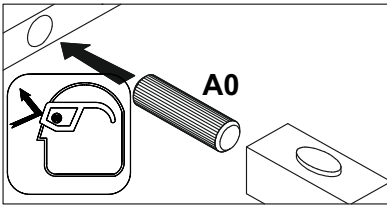
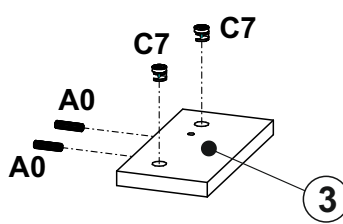
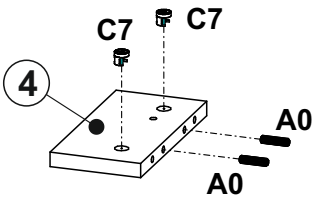
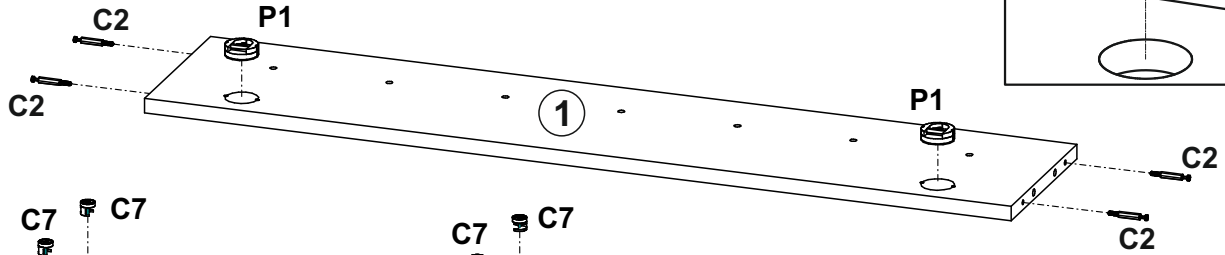
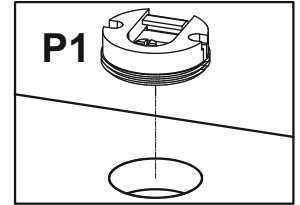

# 2

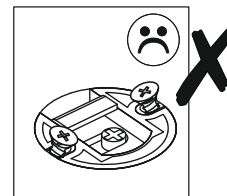
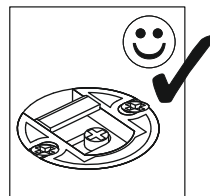

<b>D22</b>
5x11
<b>x4</b>

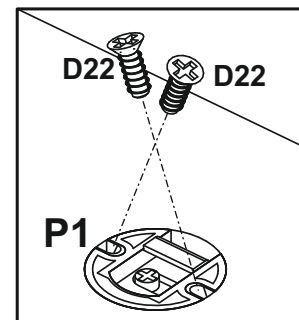
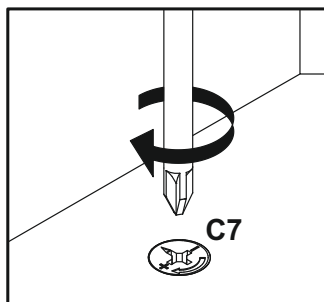
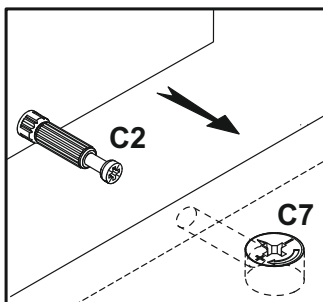
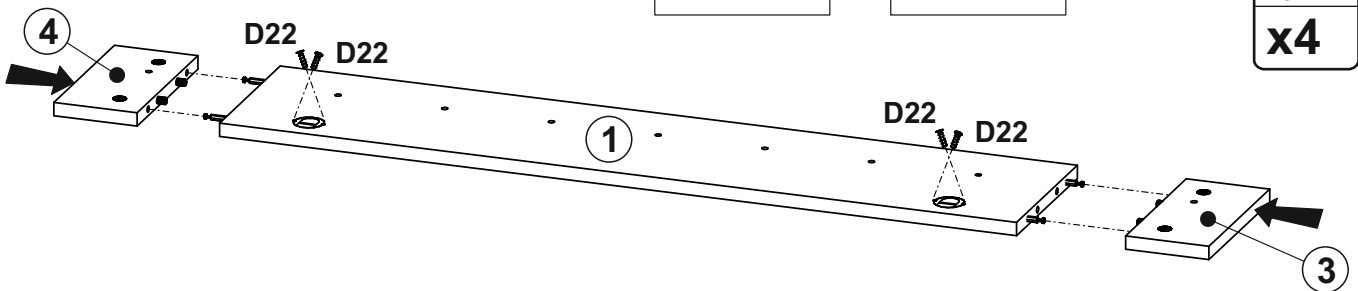

# 3

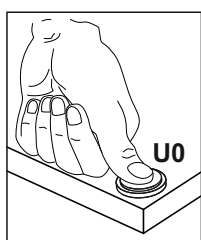
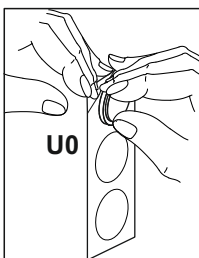
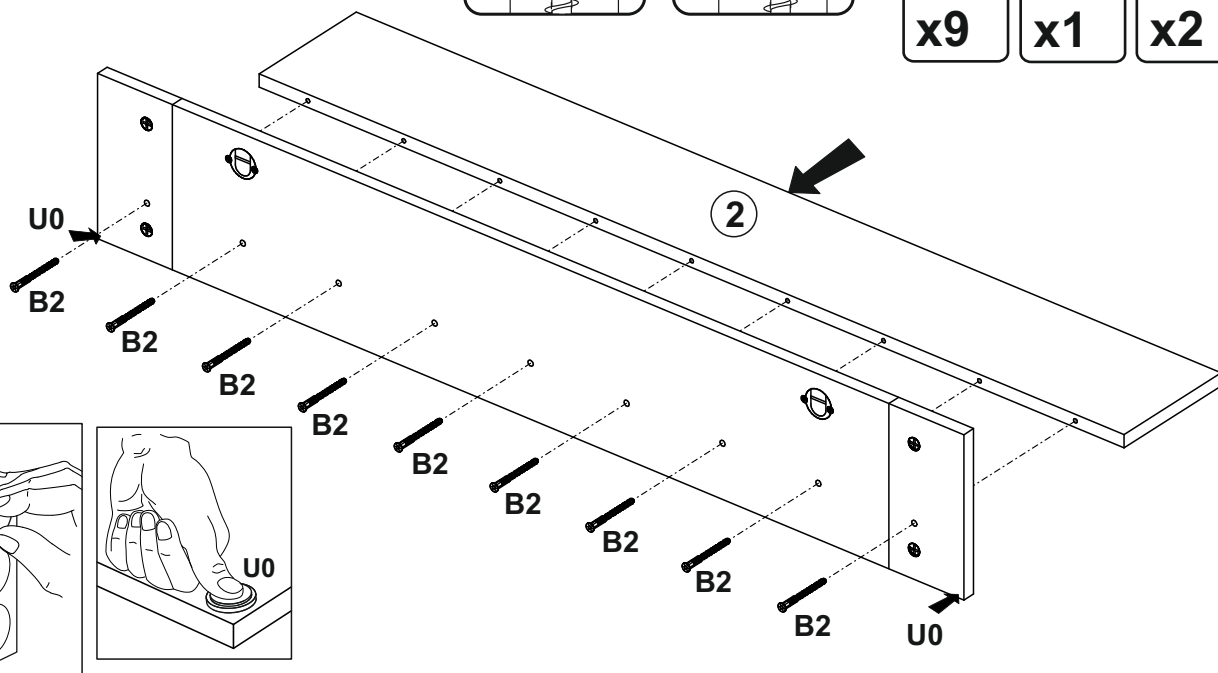
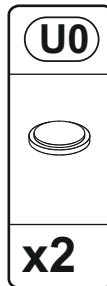
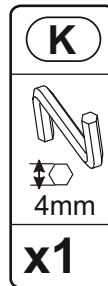
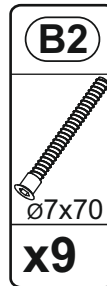
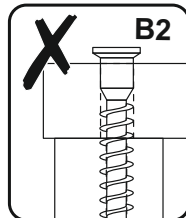
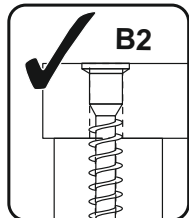
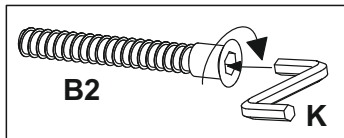

# 4

