

OLJE 1W1S

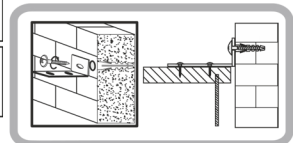

L

R

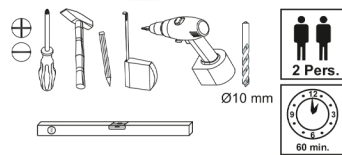
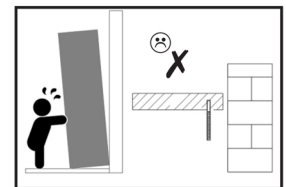
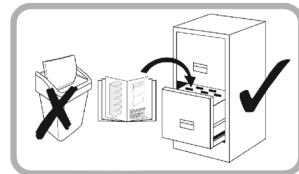
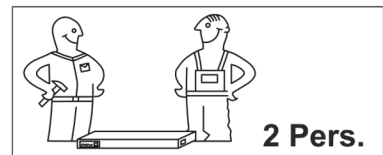
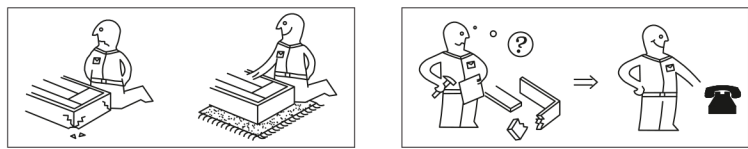
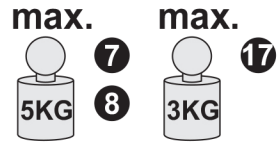
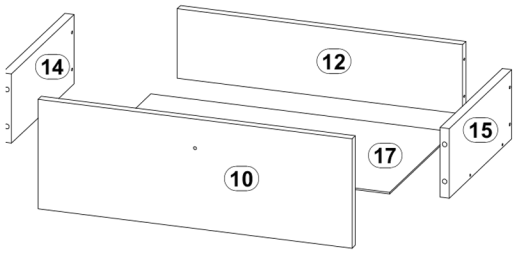
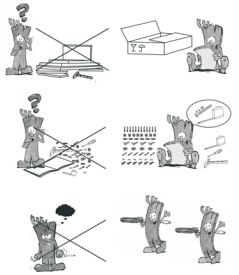
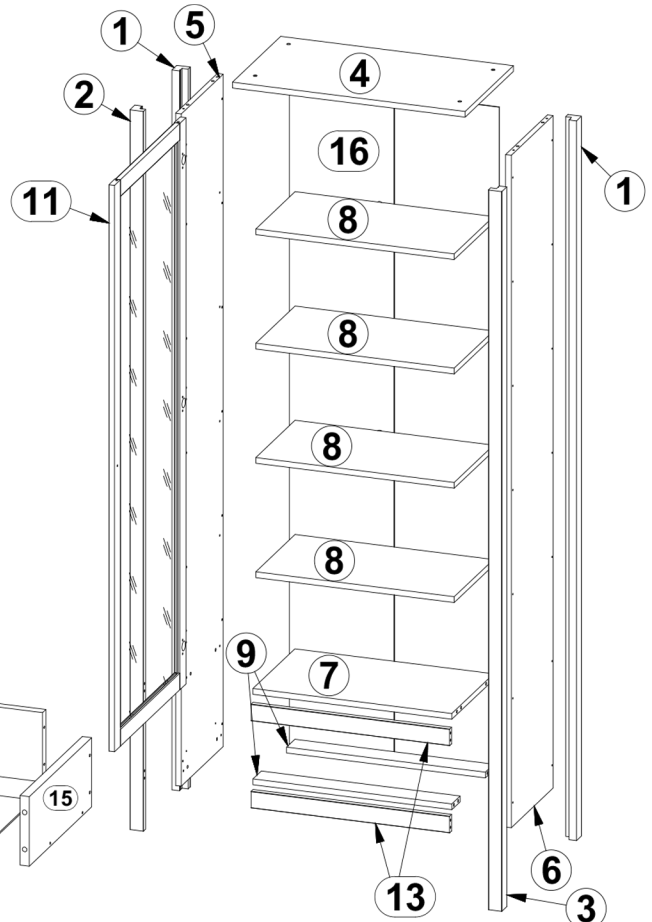
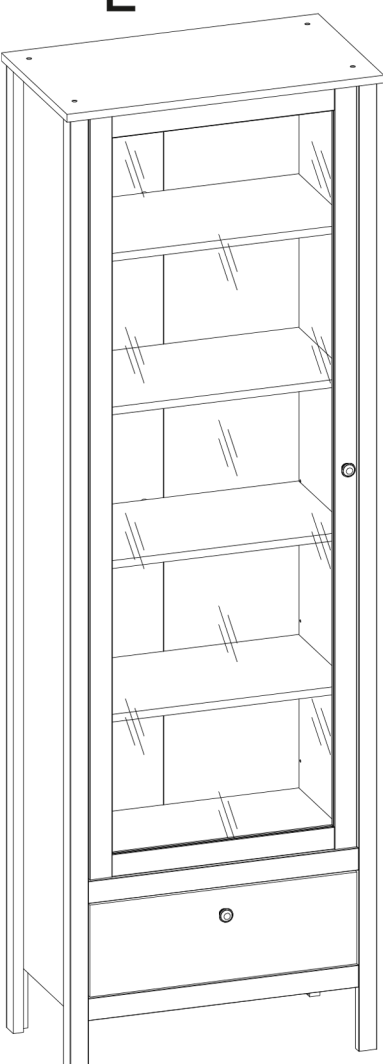

- 3x a1
- 3x b1
- 2x c415
- 16x d1 $\phi 5 \times 17$ mm
- 1x d5
- 4x e1 $\phi 7 \times 50$ mm
- 4x e3 $\phi 6 \times 13$ mm
- 4x e19 $\phi 5 \times 9$ mm
- 16x f1 $\phi 8 \times 30$ mm
- 8x f9 $\phi 6 \times 30$ mm
- 1x f35 $\phi 10 \times 50$ mm
- 2x j30 M4 $\times 22$ mm
- 4x k1
- 13x l1
- 12x l2
- 1x n14 $\phi 2 \times 15 \times 1,5$ mm
- 1x z1
- 4x p10 $\phi 4 \times 40$ mm
- 1x p17 $\phi 5 \times 60$ mm
- 2x p38 $\phi 3,5 \times 16$ mm
- 28x p125 $\phi 3 \times 30$ mm
- 8x r1 $\phi 15 \times 12$ mm
- 8x r42 2011 $\phi 5 \times 40$ mm
- 7x s4 $\phi 5$
- 28x s59
- 5x s67
- 1x w37CL 300 mm
- 1x w37CR 300 mm
- 1x w37DL 300 mm
- 1x w37DR 300 mm
- 1x y1

A	B			C	D	A	B			C	D
1	1990	38	38	2	2/2	10	548	189	16	1	1/2
2	1990	38	38	1	2/2	11	1566	548	16	1	2/2
3	1990	38	38	1	2/2	12	498	120	16	1	1/2
4	650	370	16	1	1/2	13	554	46	16	2	1/2
5	1859	321	16	1	2/2	14	300	120	16	1	2/2
6	1859	321	16	1	2/2	15	300	120	16	1	1/2
7	555	321	16	1	1/2	16	1833	585	2,5	1	2/2
8	554	301	16	4	1/2	17	306	528	2,5	1	1/2
9	555	64	16	2	1/2	-	Accessories			1	1/2

1

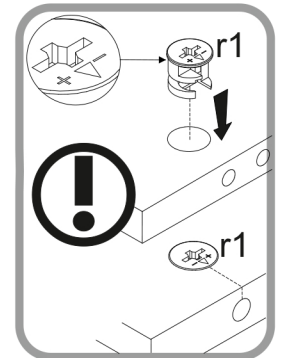
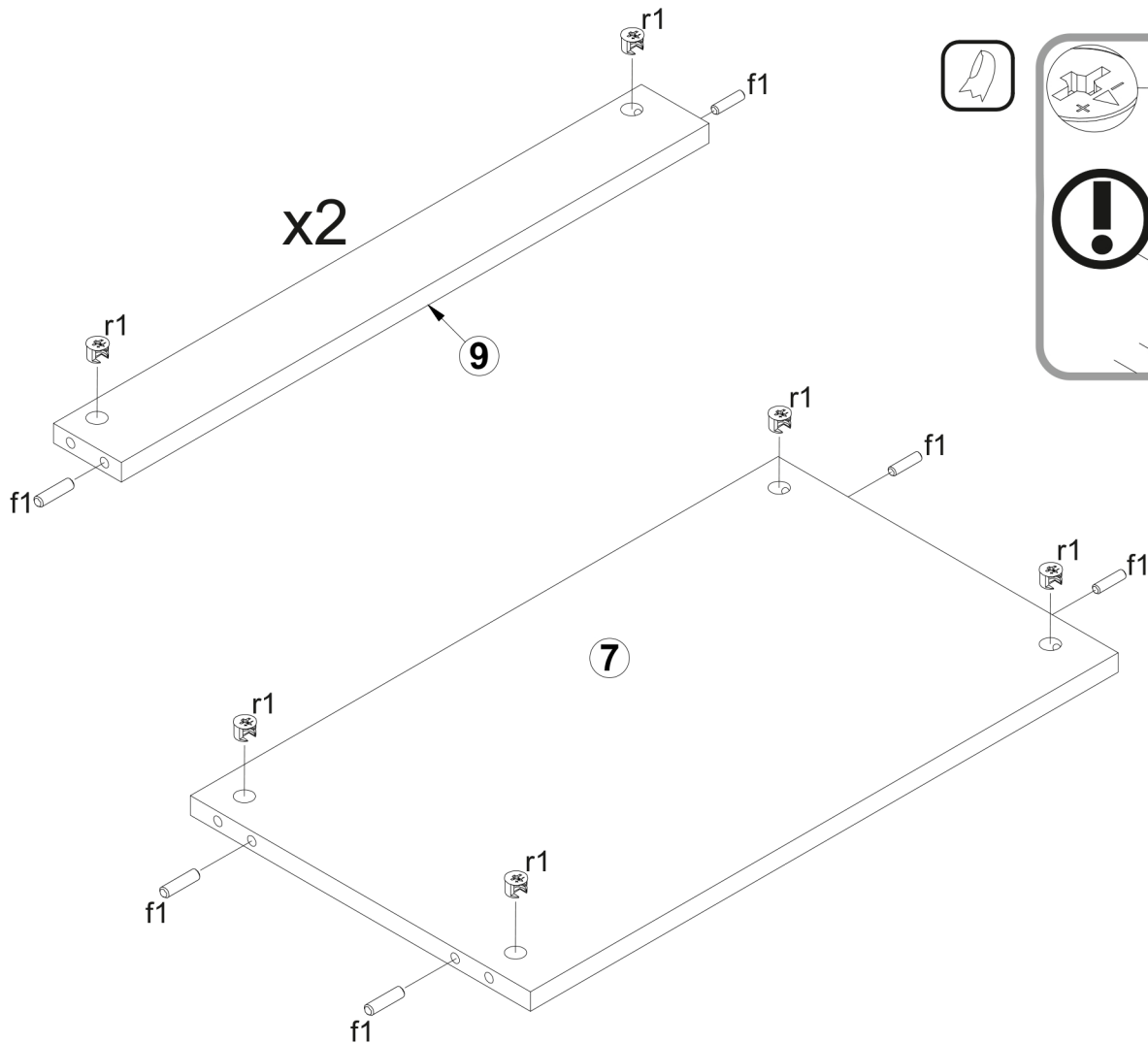
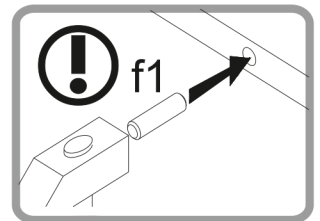
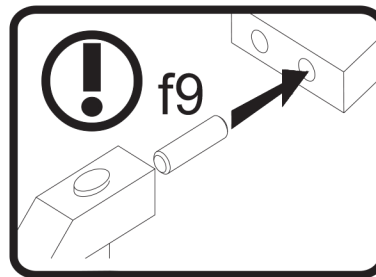
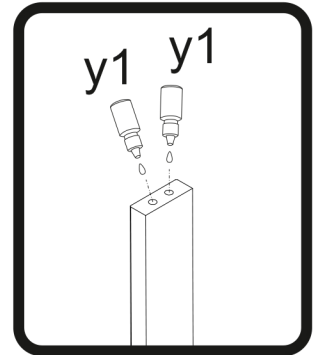
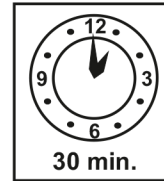
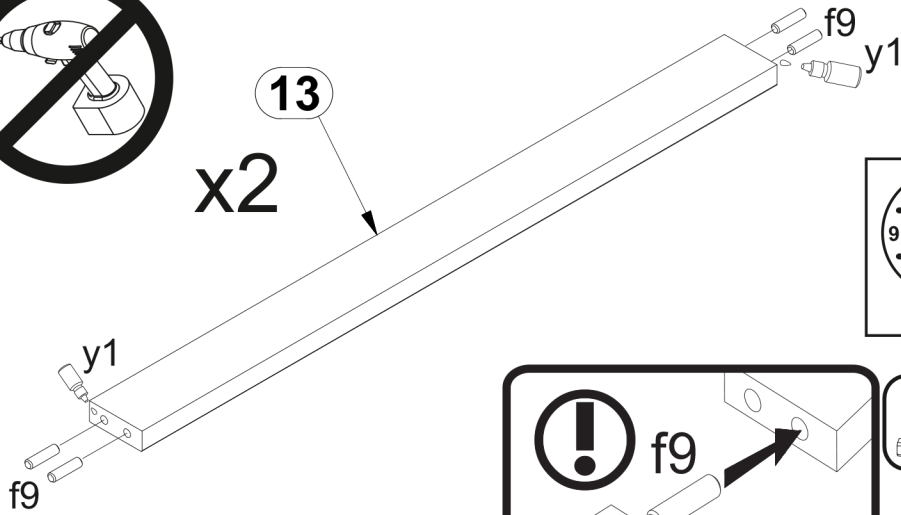
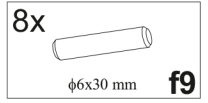
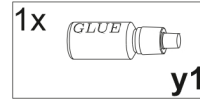
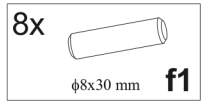
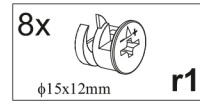
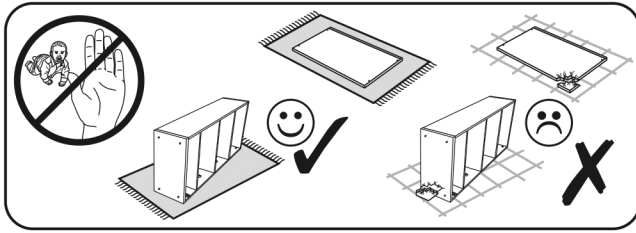

2

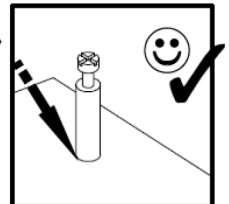
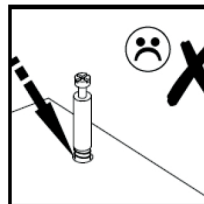
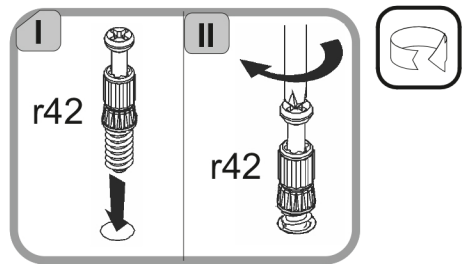
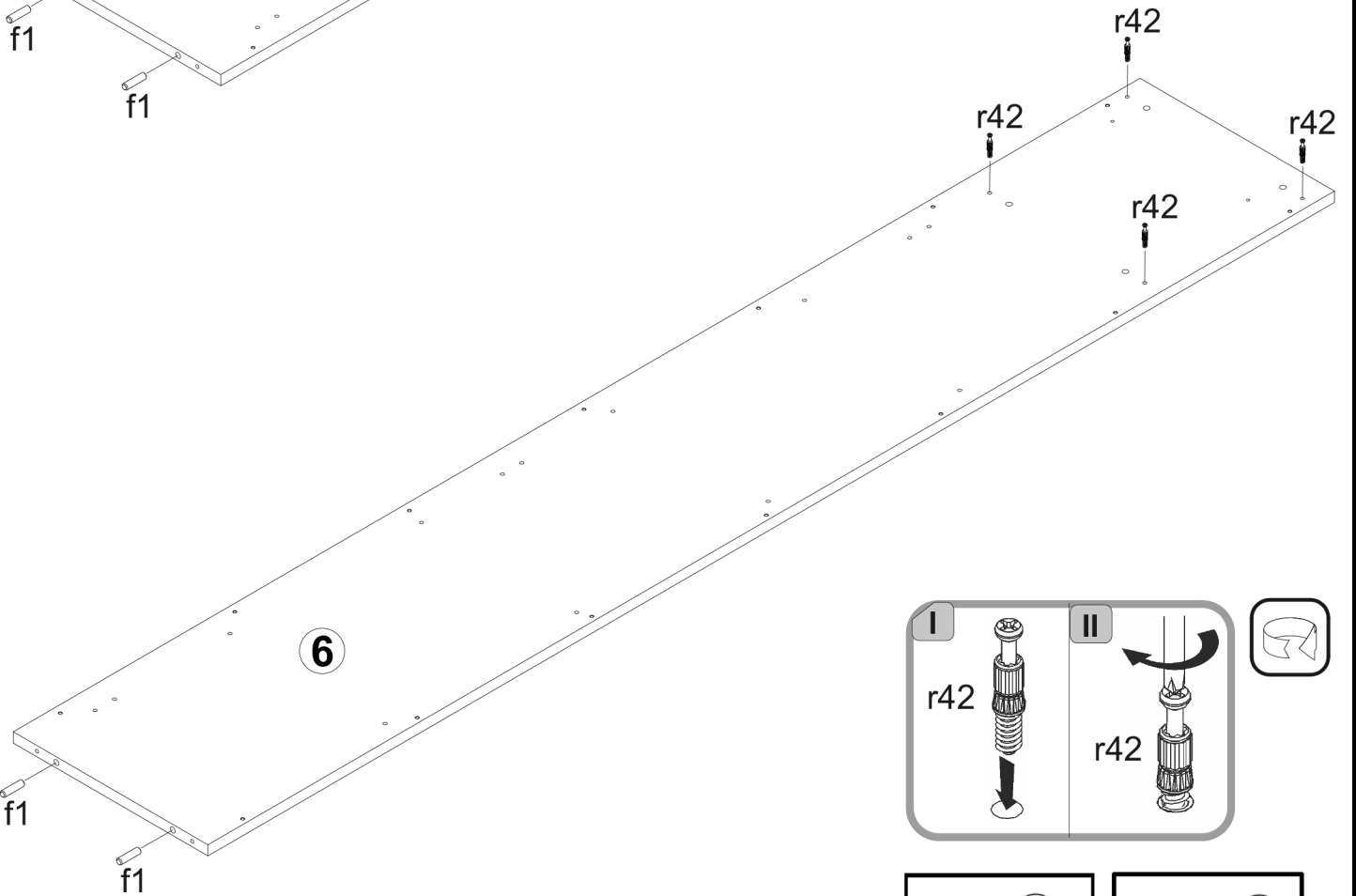
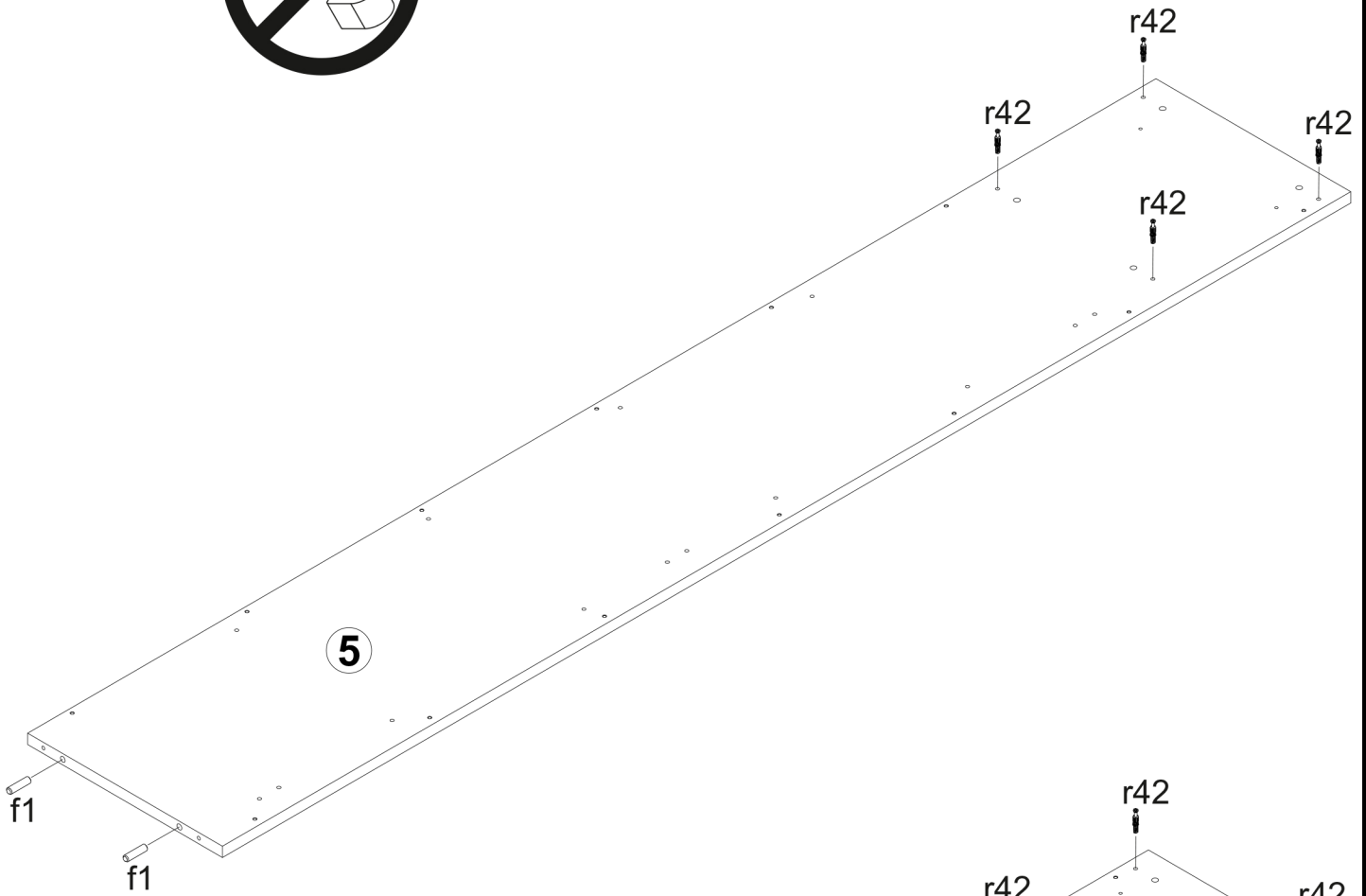
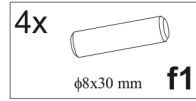

3

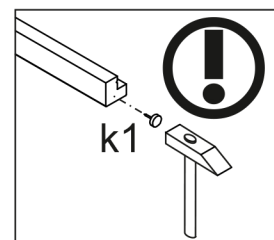
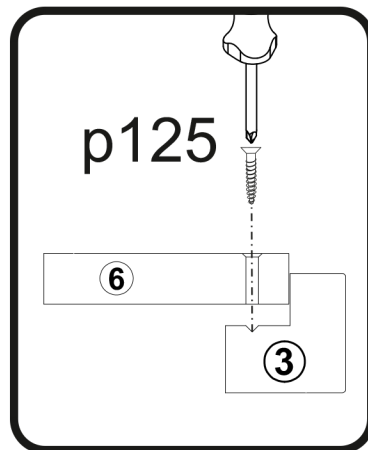
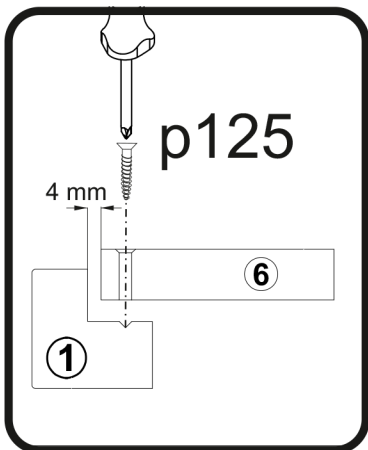
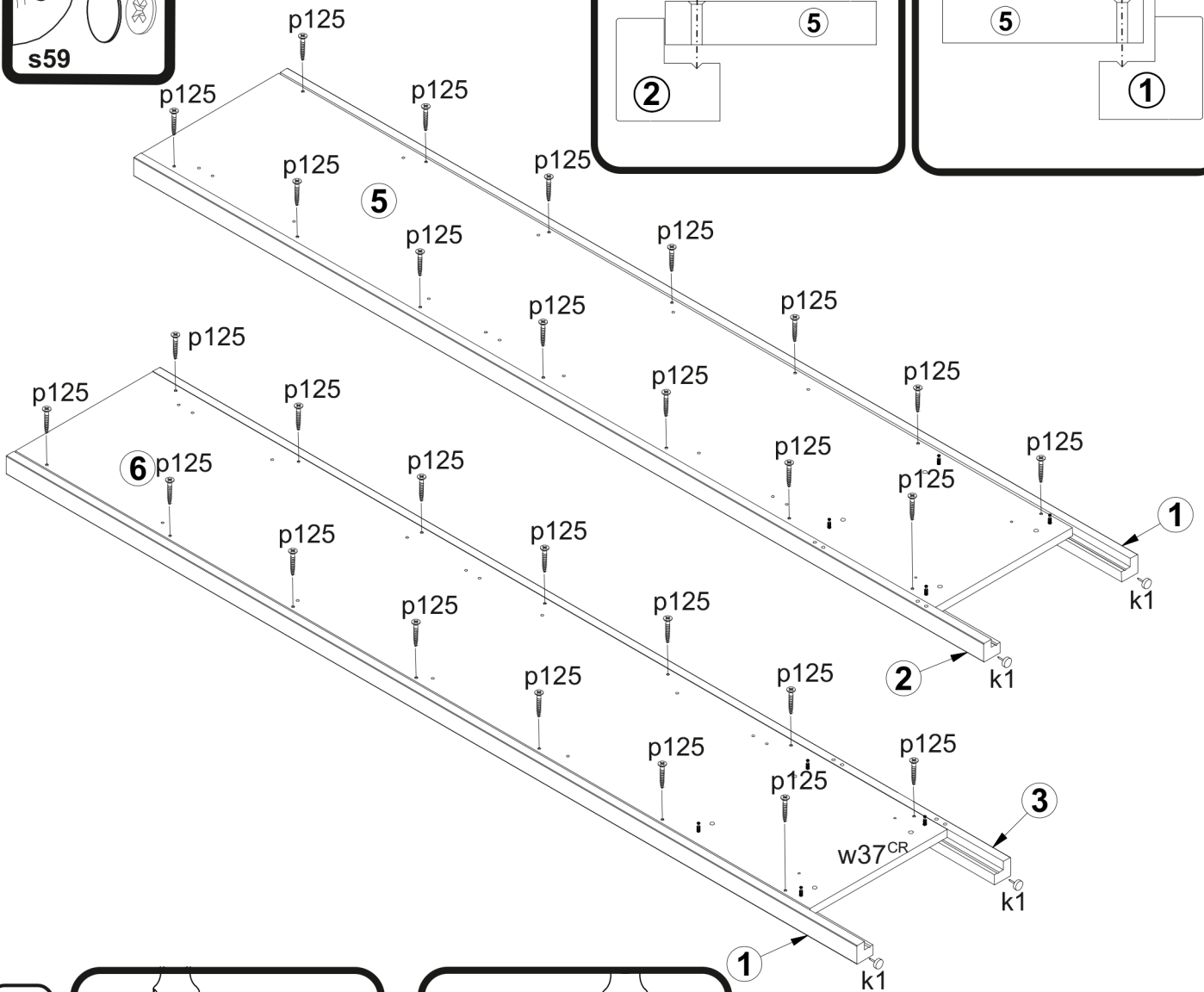
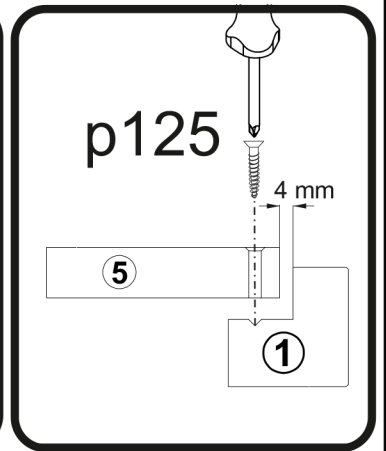
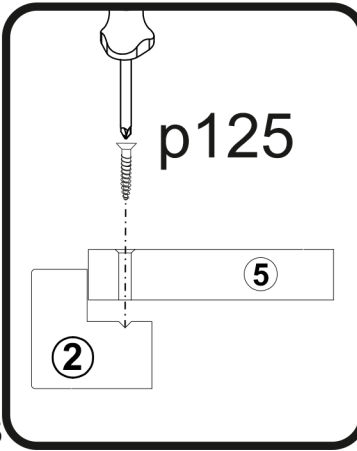
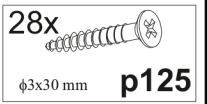
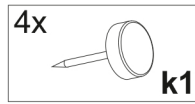
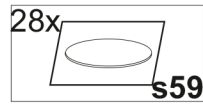

4



1x
300 mm
w37^{CR}

1x
300 mm
w37^{CL}

4x
φ6x13 mm
e3

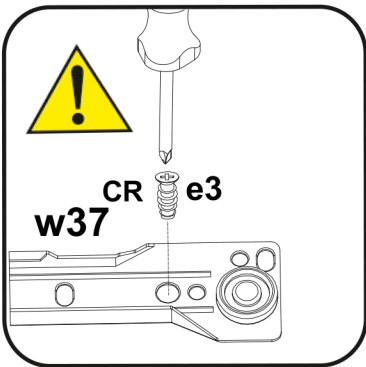
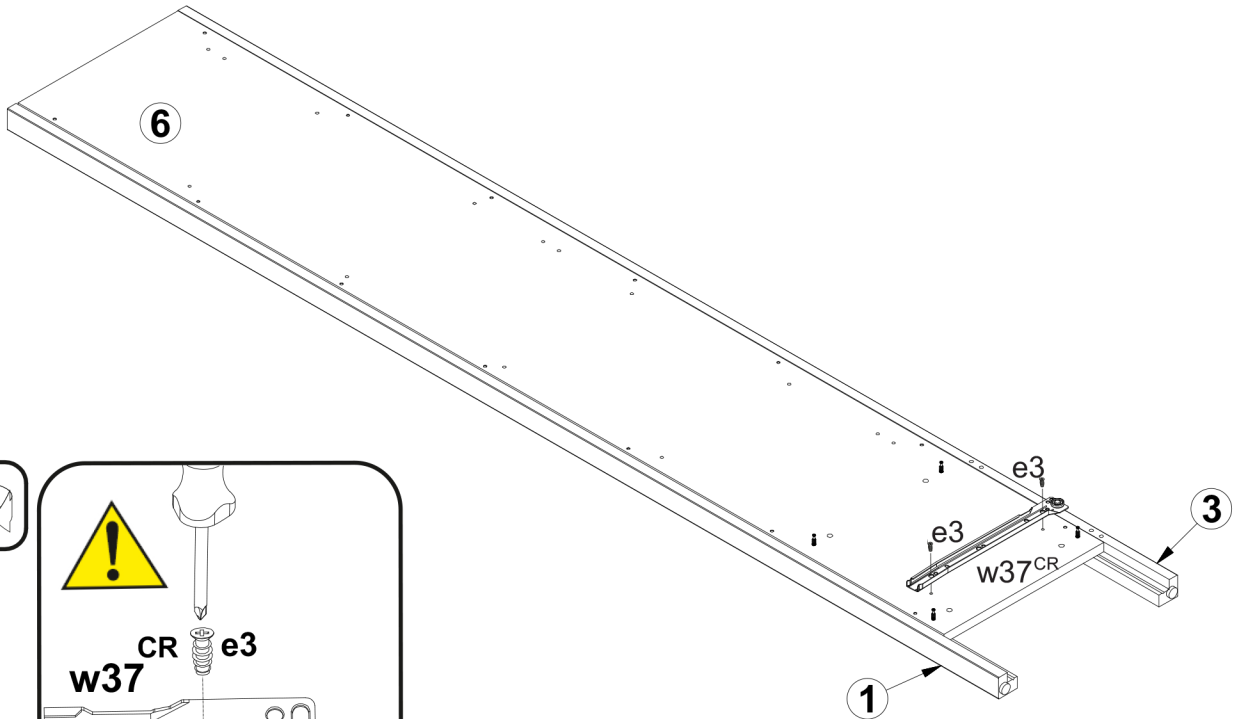
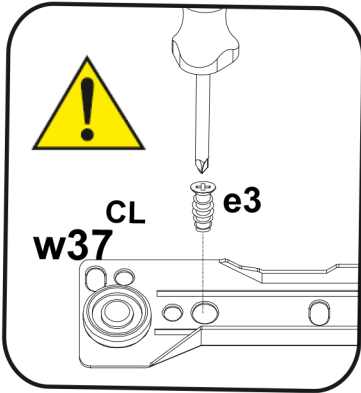
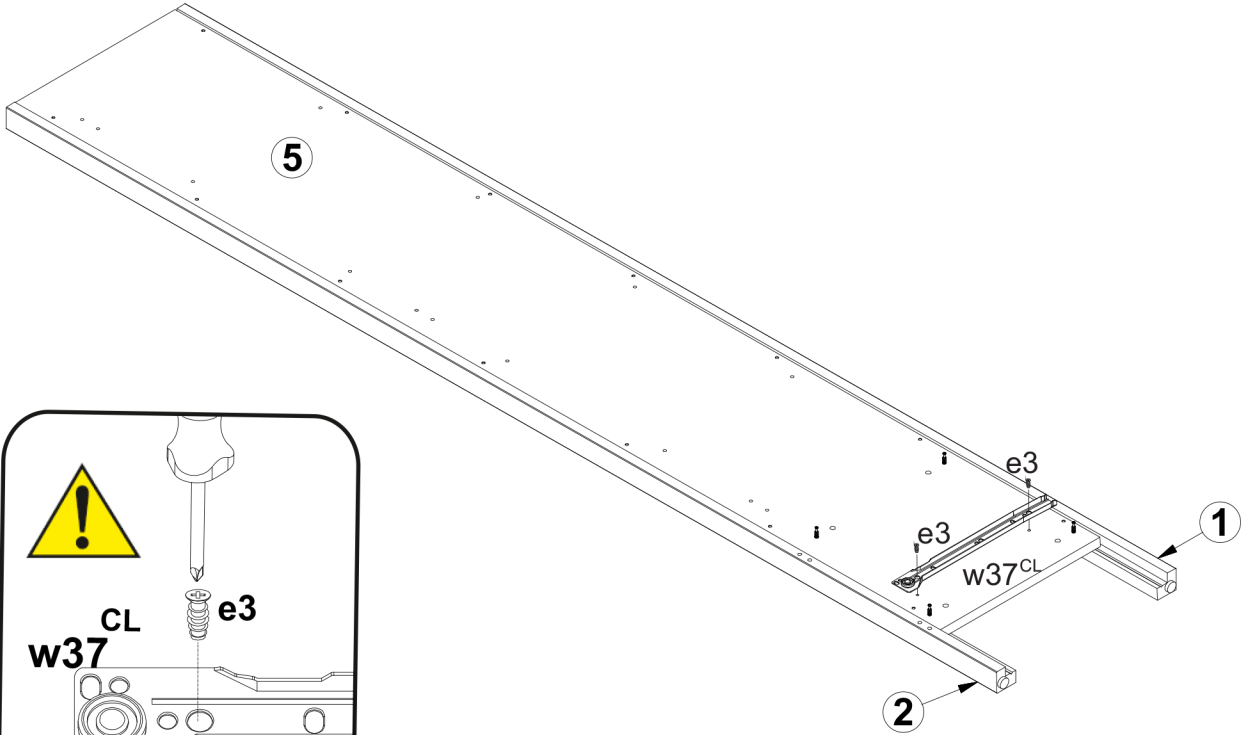

5

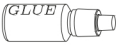
1x  y1

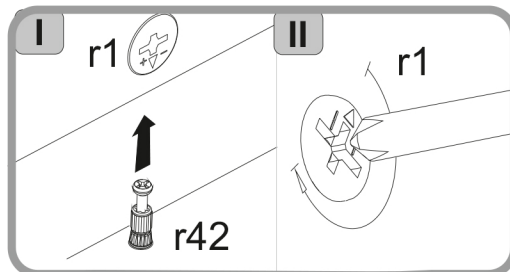
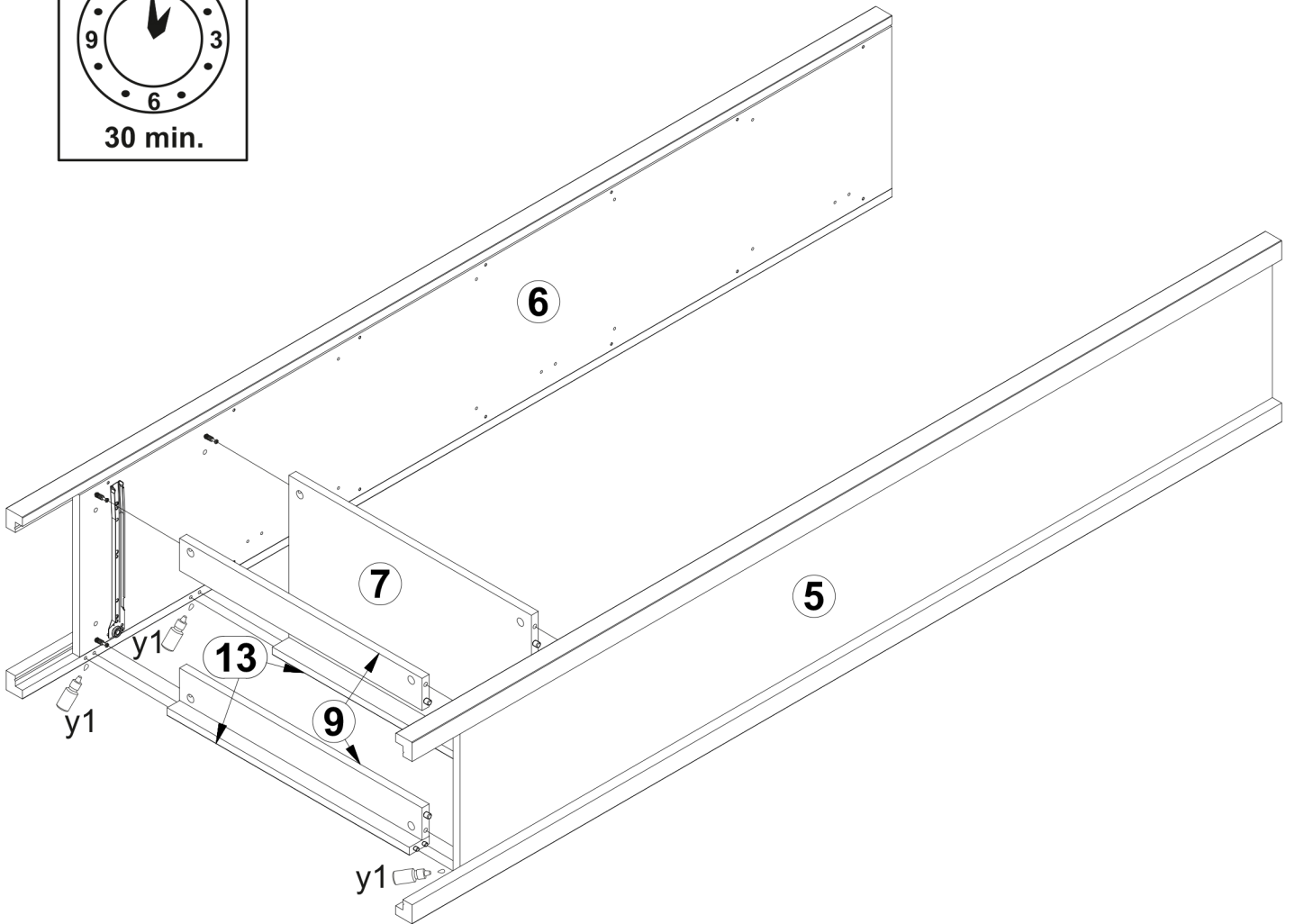
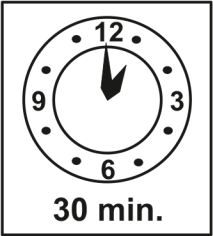

6

4x
φ7x50 mm
e1

1x
z1

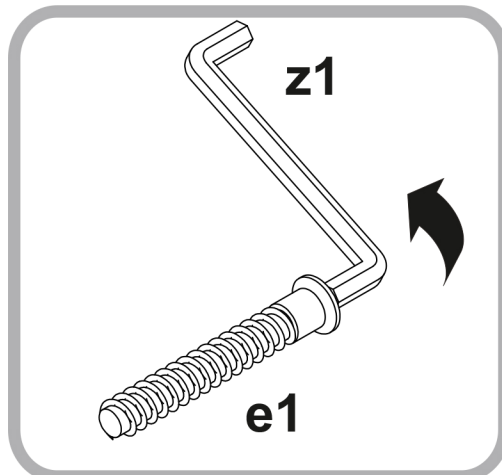
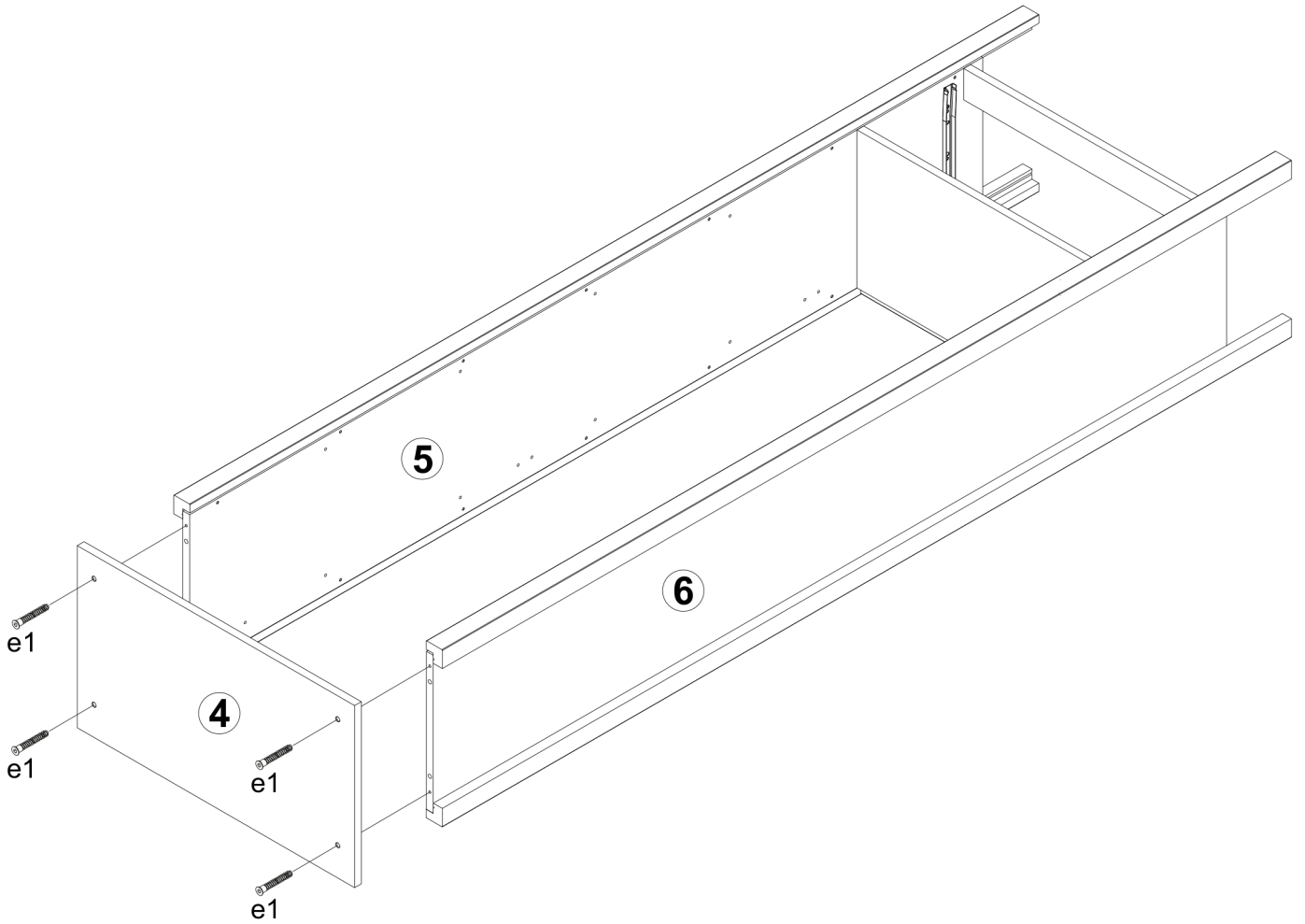

8

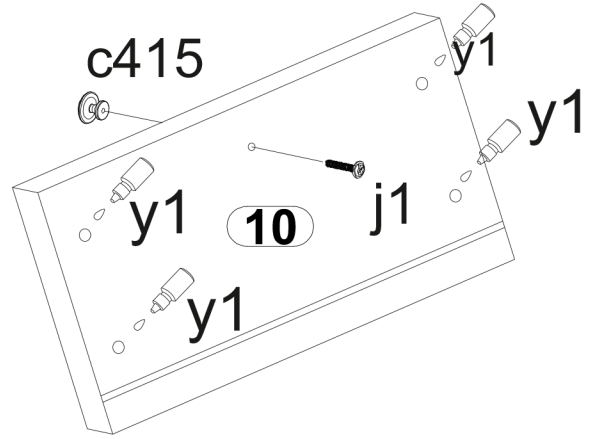
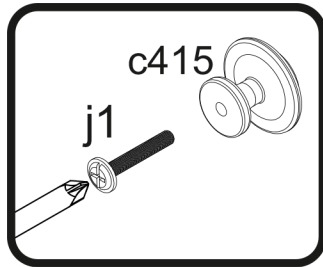
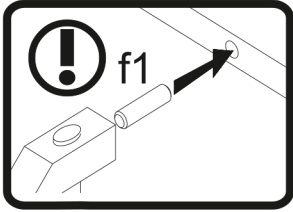
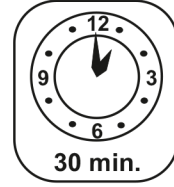
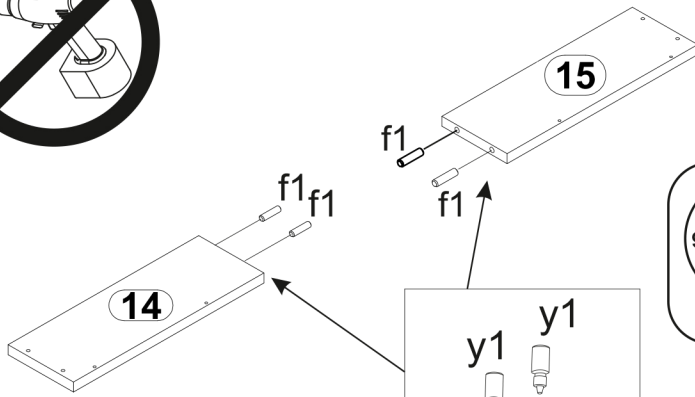
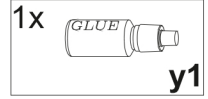
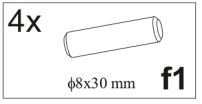

9

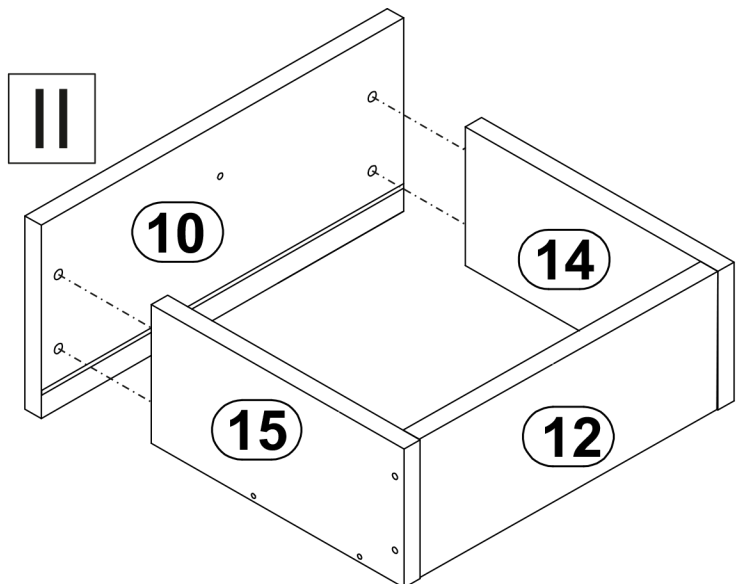
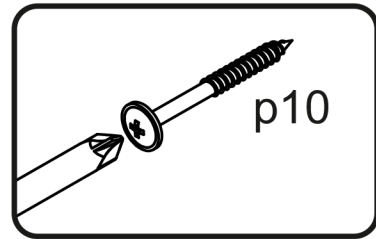
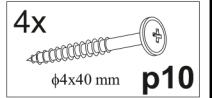
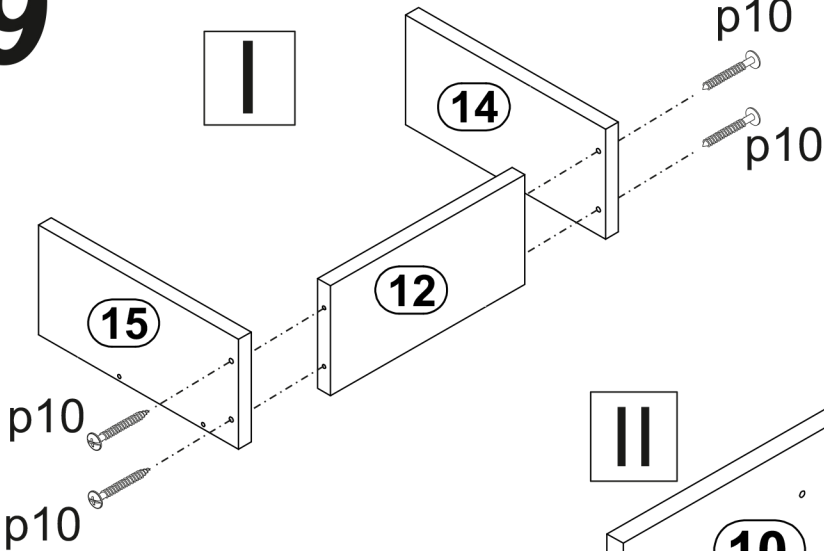

10



1x
300 mm
w37^{DL}

4x
φ5x9 mm e19

1x
300 mm
w37^{DR}

5x
I1

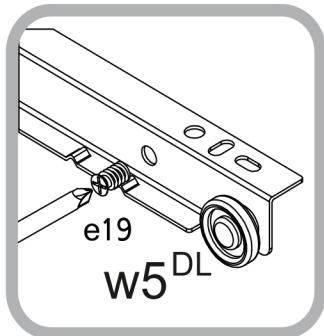
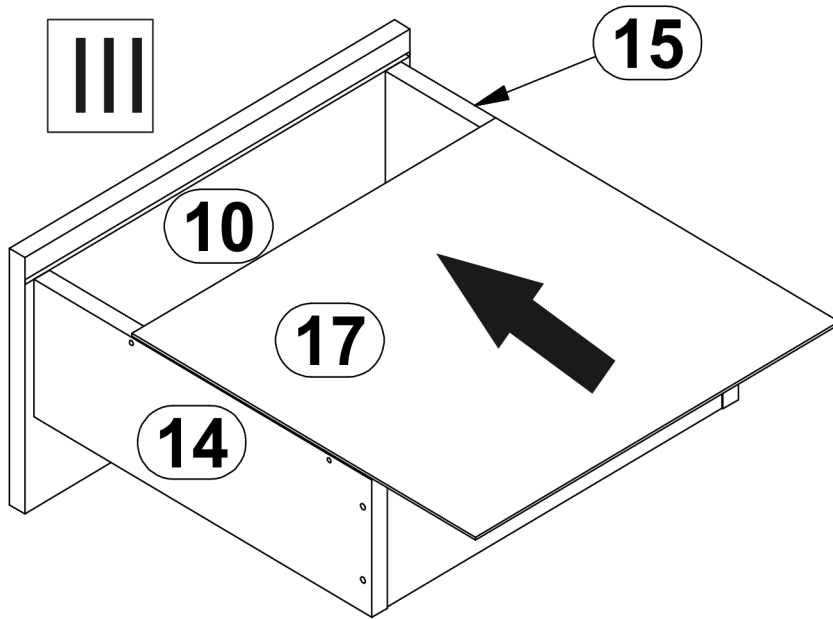

IV

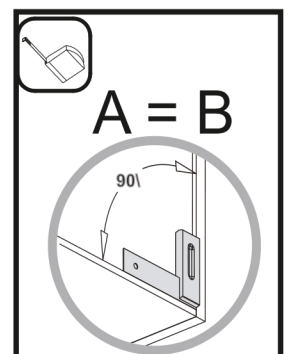
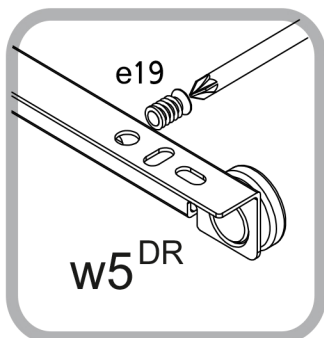
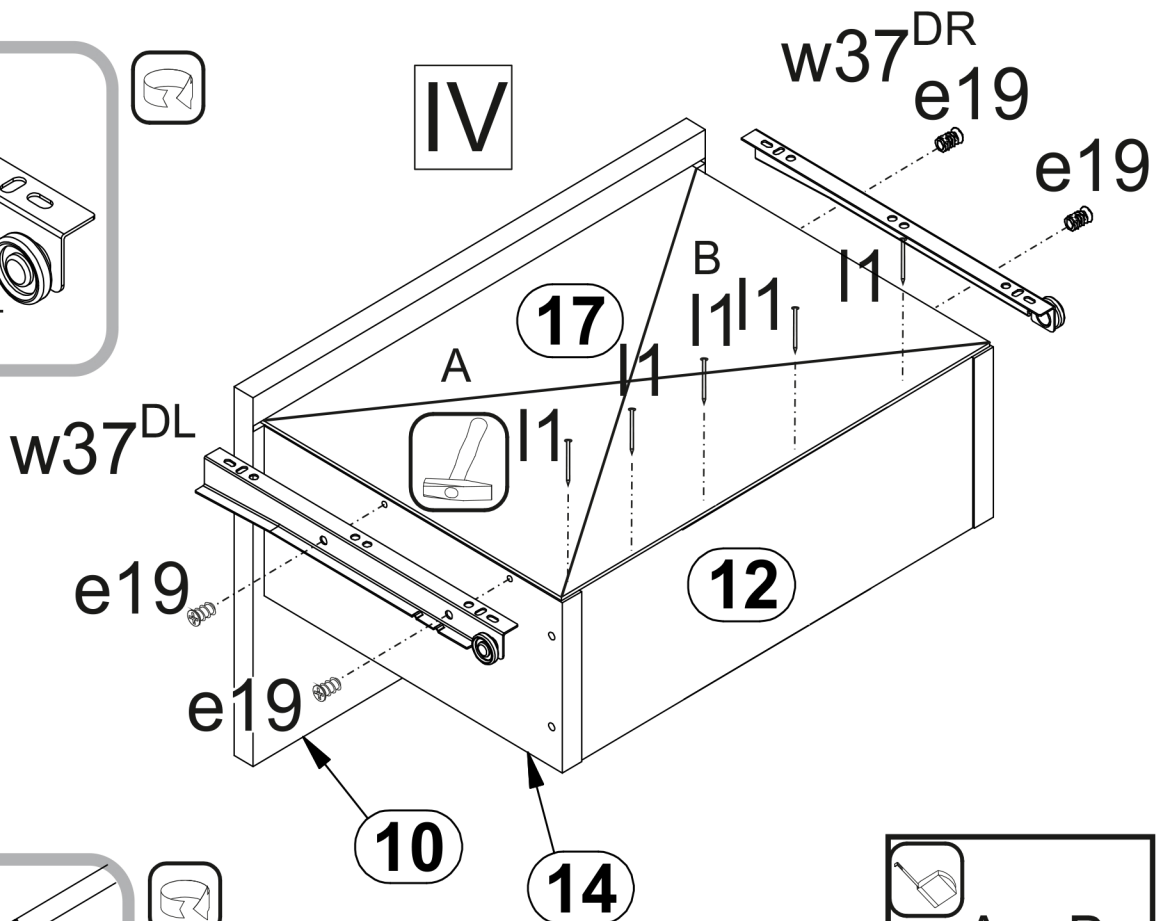

11

5X  s67

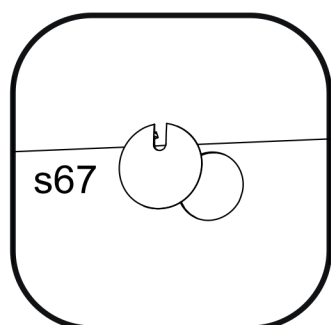
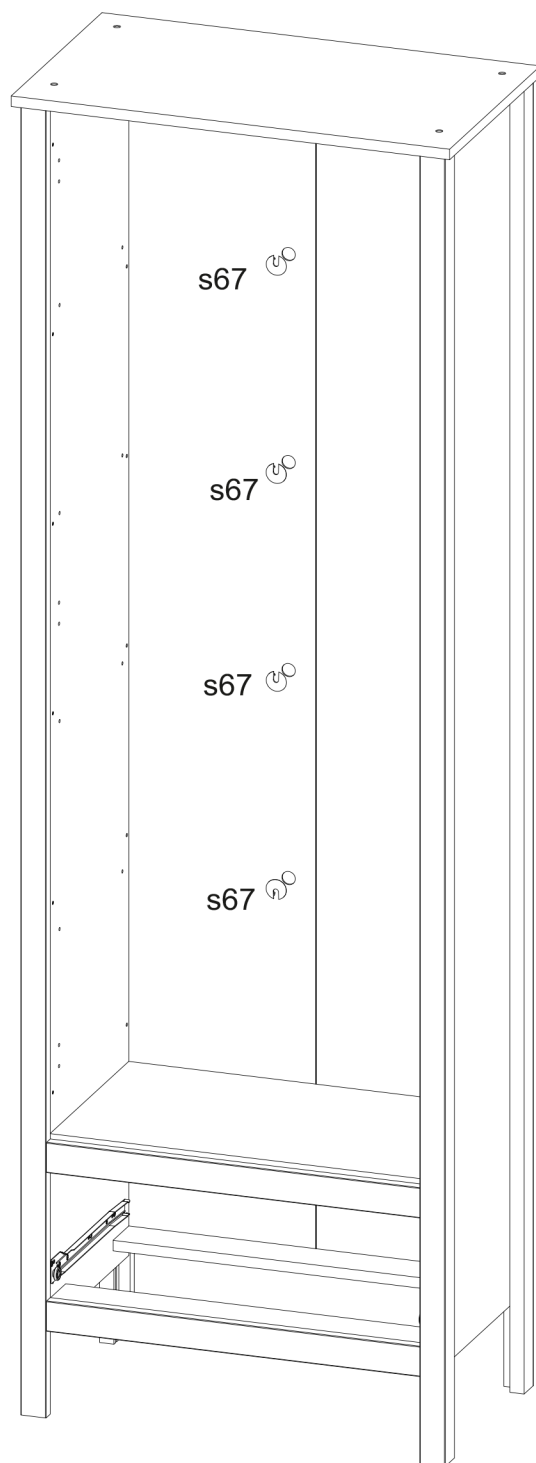

12

16x 
φ5x17 mm d1

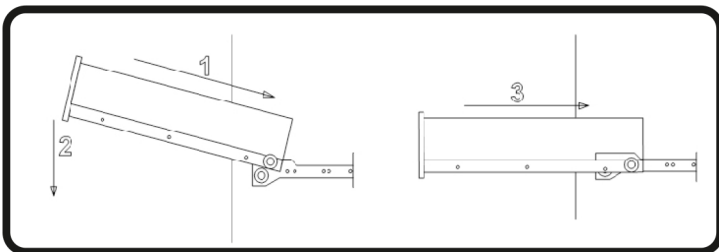
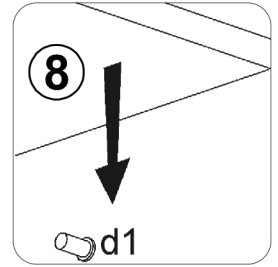
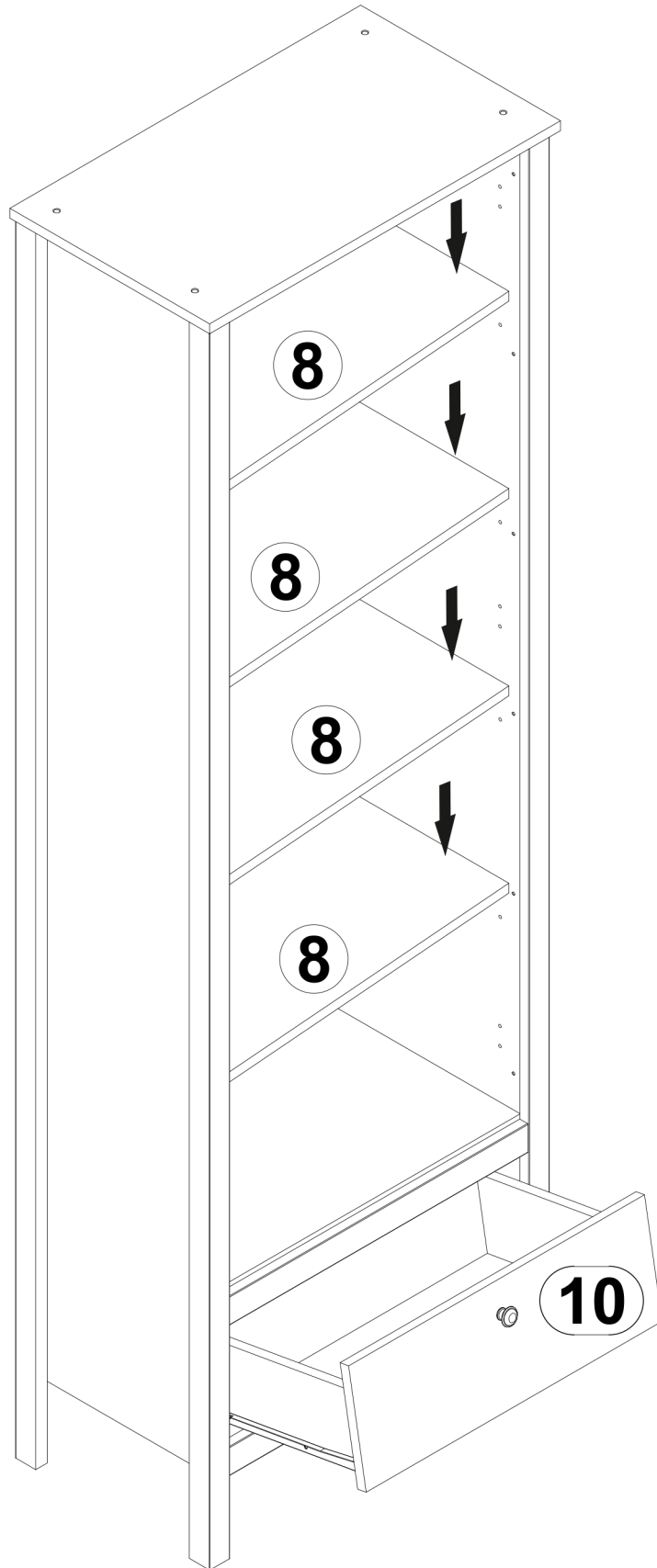
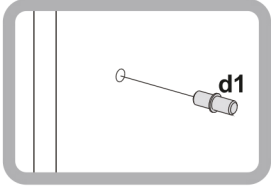

13

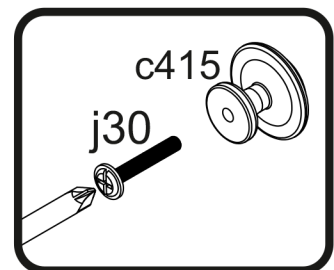
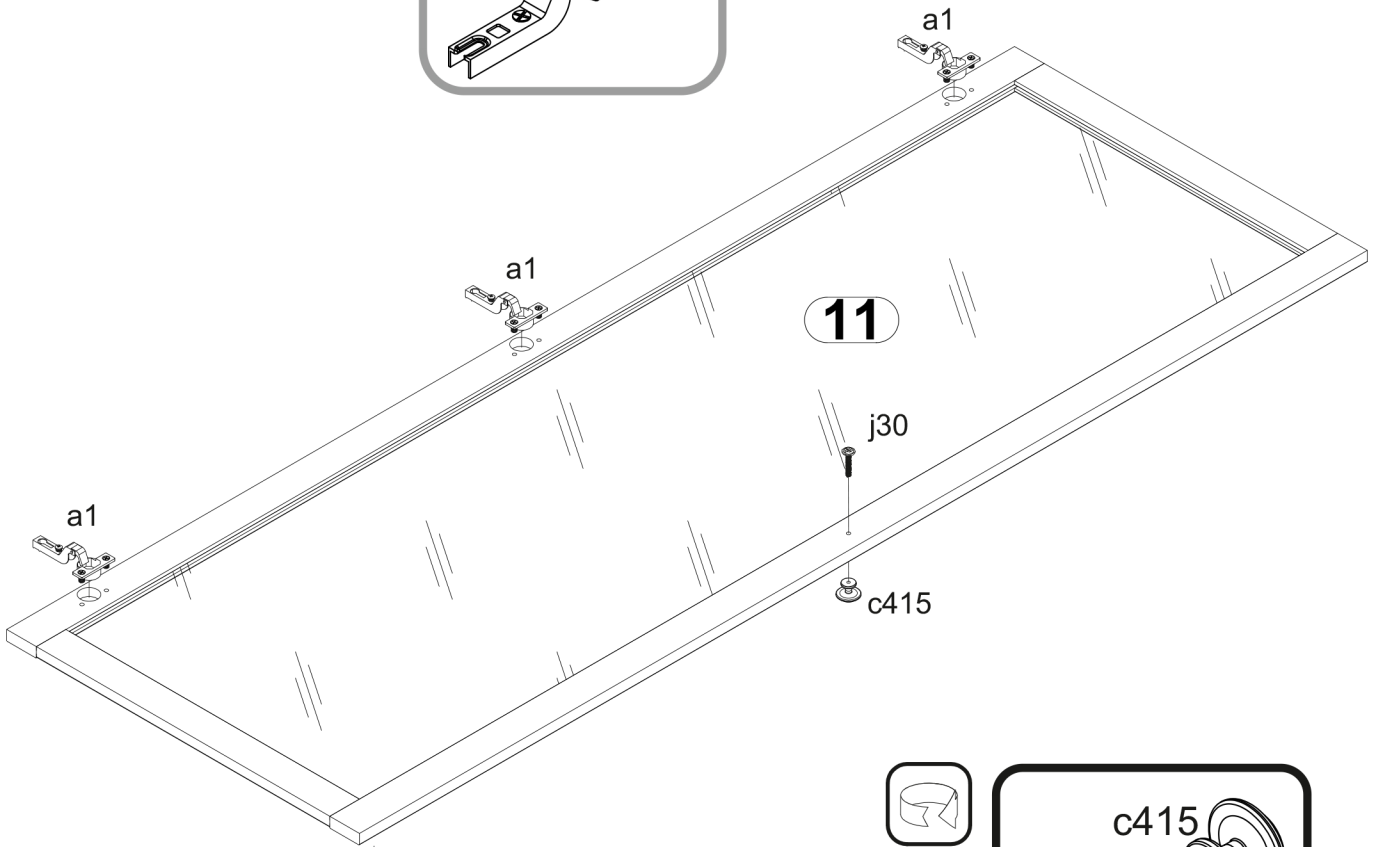
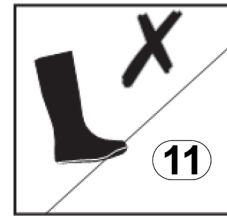
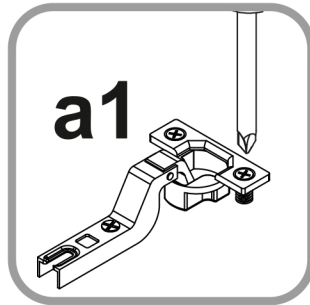
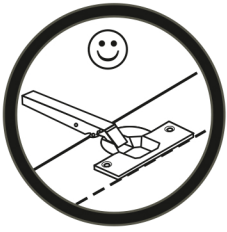
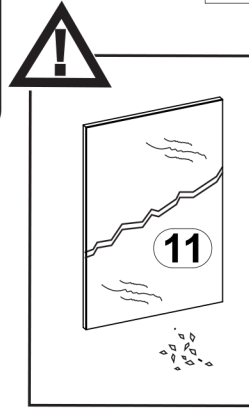
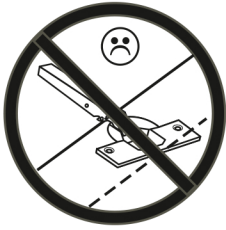
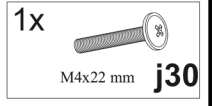
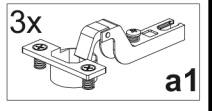
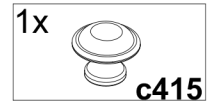
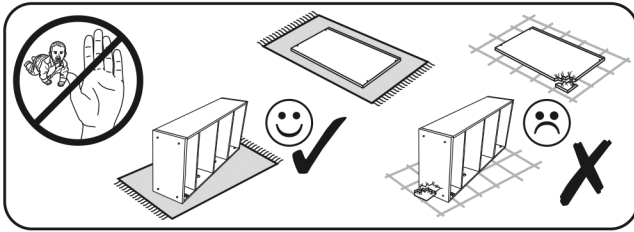

14 L

7x
ø5



s4

1x

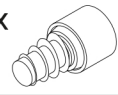

d5

3x

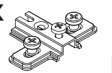

b1

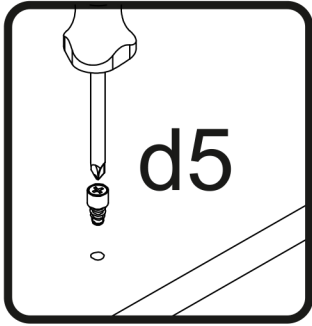

d5

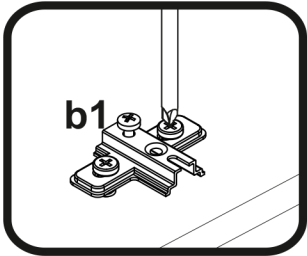

b1

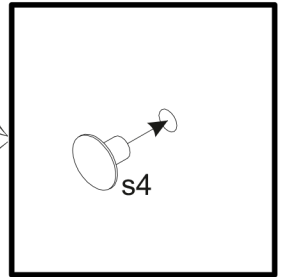
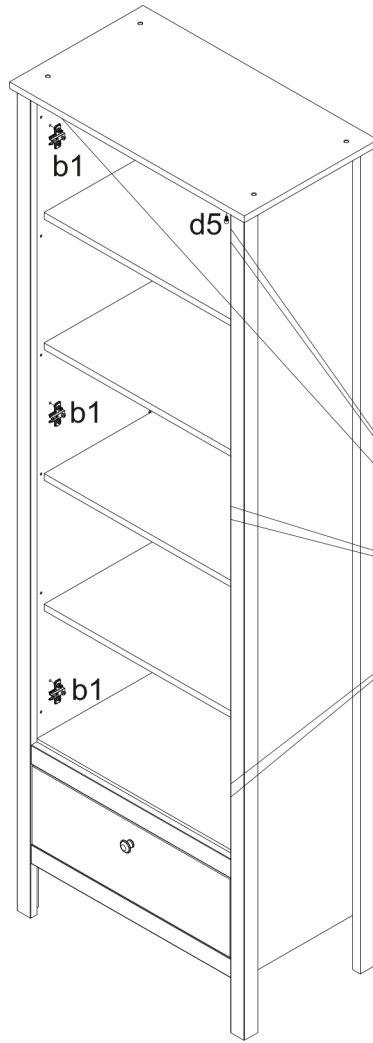

s4

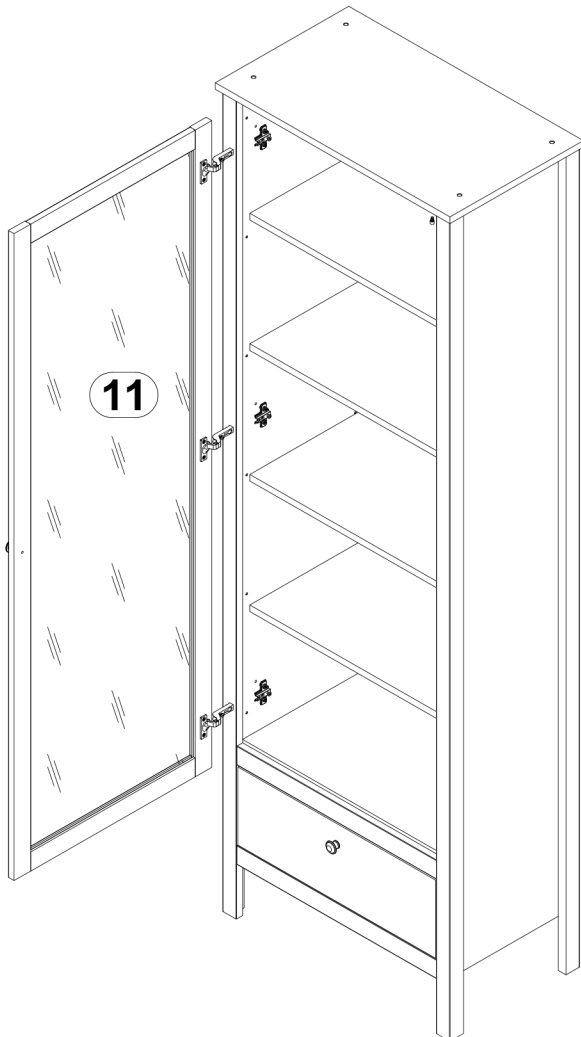

11

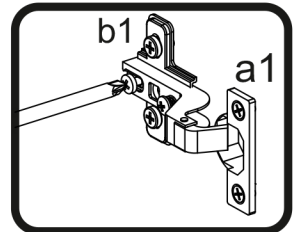

b1

a1

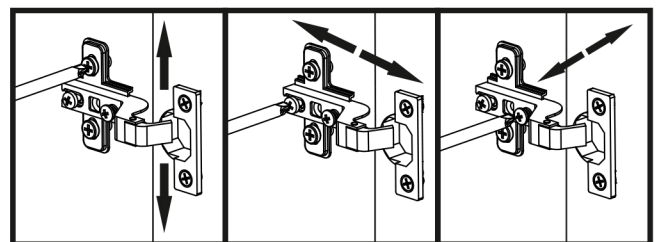

14 R

7x
ø5



s4

1x

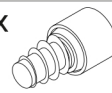

d5

3x

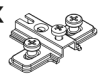

b1

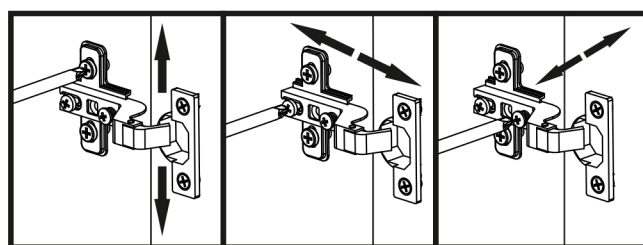
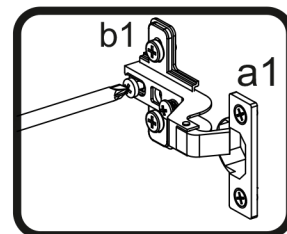
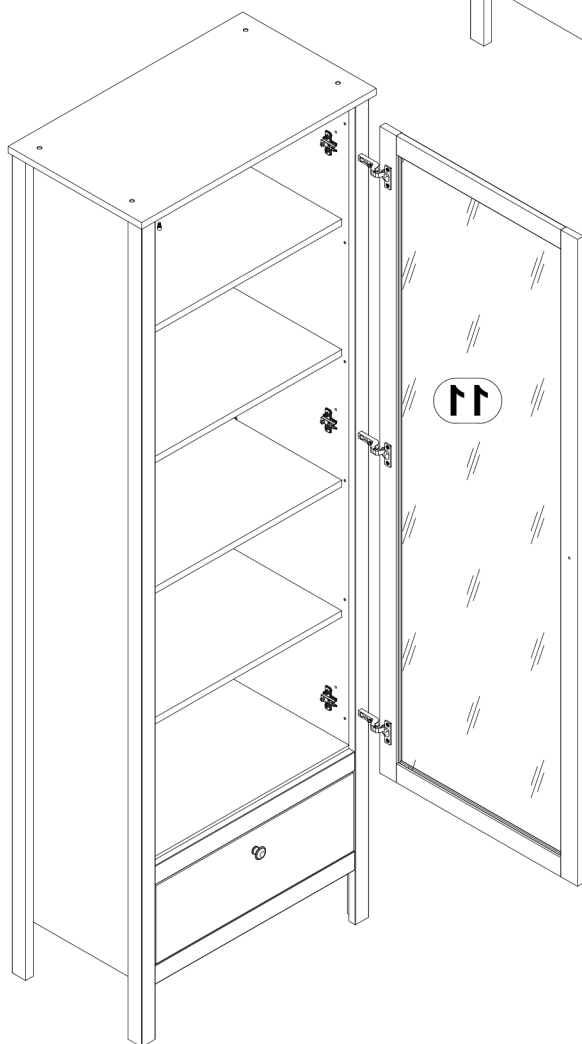
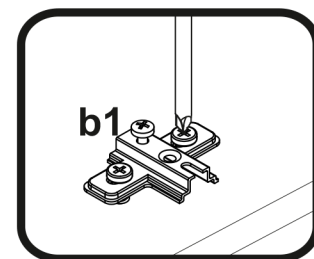
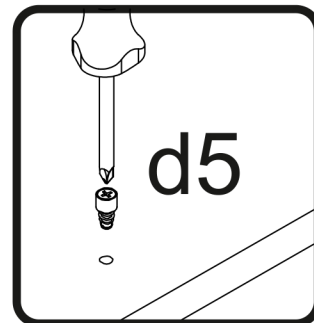
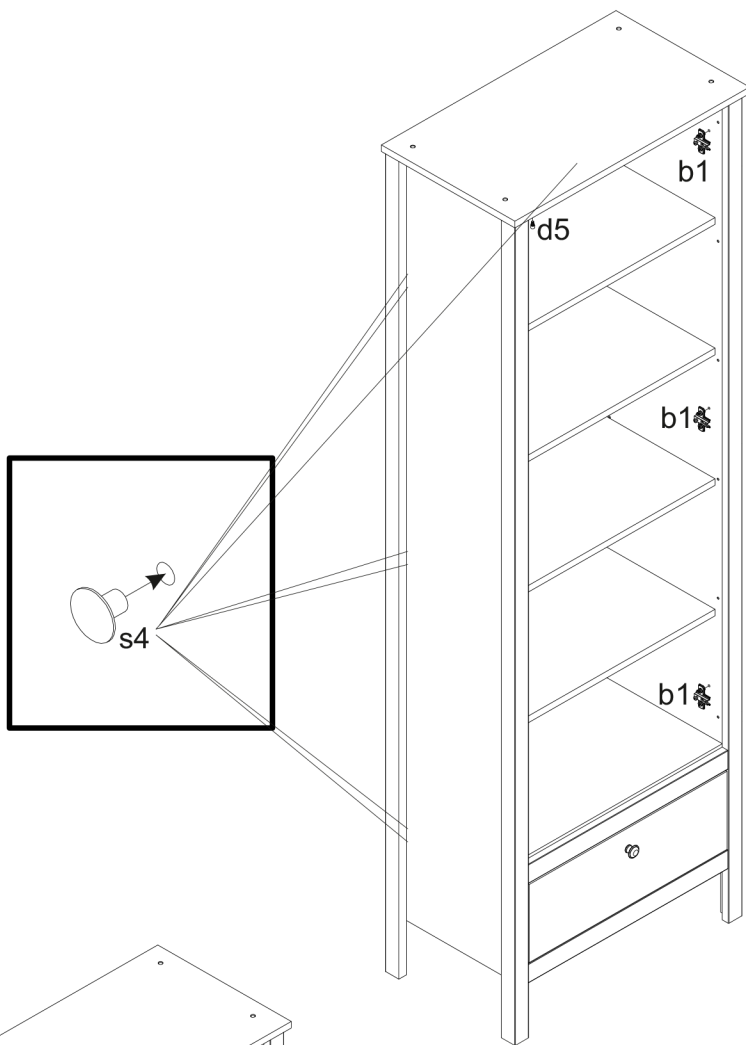

15

