

2490x2040x300 mm

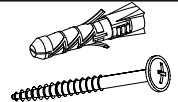
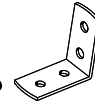
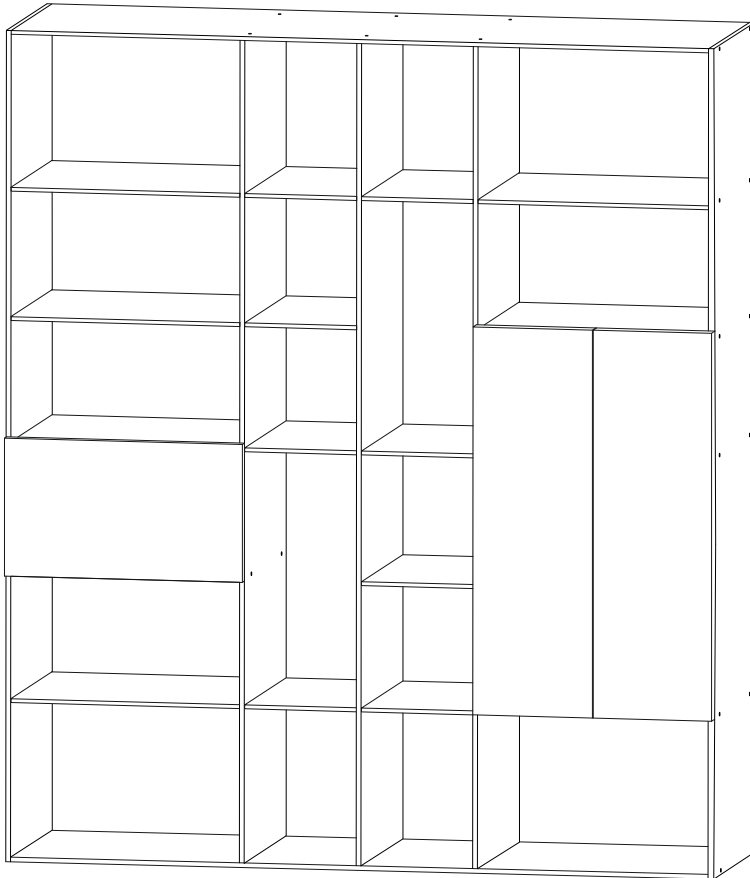

To avoid falling

we recommend fixing the product to the wall using **corners** or **double-sided tape**. Purchase separately.

(ENG)

Щоб уникнути падіння виробу

рекомендуємо закріпити його до стіни кутиками чи двосторонньою стрічкою. Необхідно придбати окремо.

(UA)

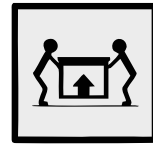

(ENG)

RULES FOR USE AND CARE OF FURNITURE

1. Use furniture only in dry rooms protected from the effects of weather conditions.
2. Install with suitable tools according to these assembly instructions.
3. Try to assemble as close to the location as possible.
4. The body is assembling in a horizontal position.
5. Before moving furniture, make sure that it is not loaded with items.
Caution: moving furniture may damage it. When moving, hold on to vertical elements only; moving furniture by horizontal parts can break the product.
6. Overloading the furniture can damage it.
7. From time to time check the fittings and their correct position.
8. Wipe the furniture surface only with a slightly damp cloth or paper towels. Do not use chemical cleaning agents other than those specifically made for this.









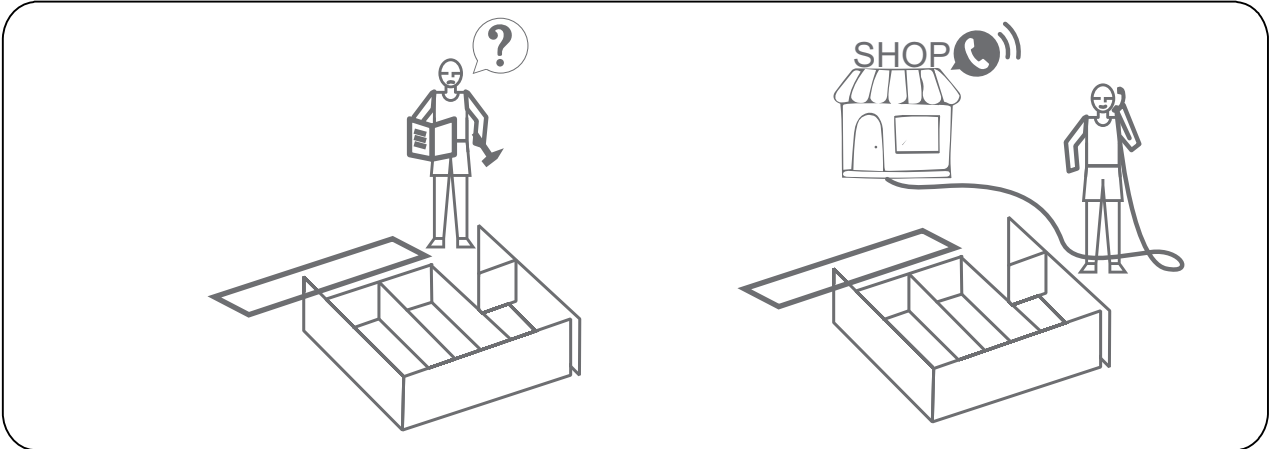
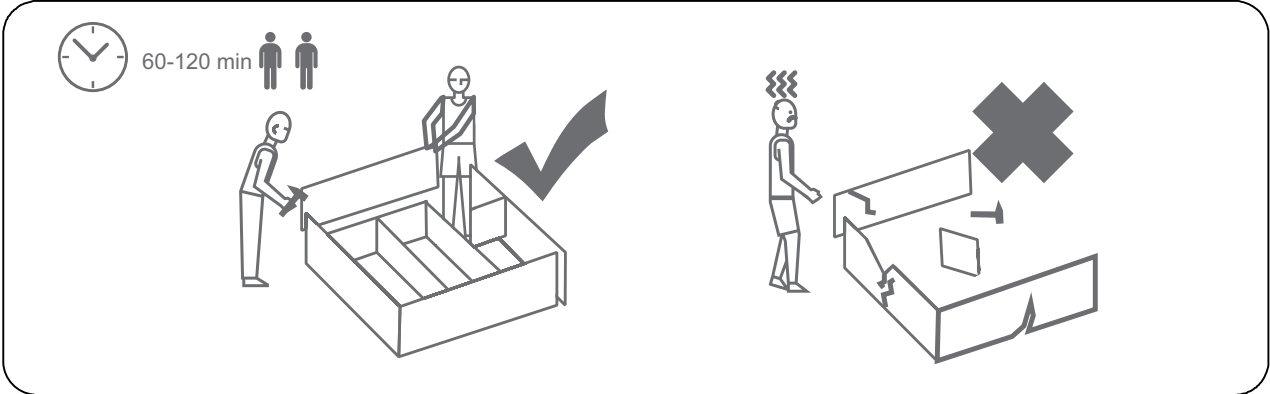
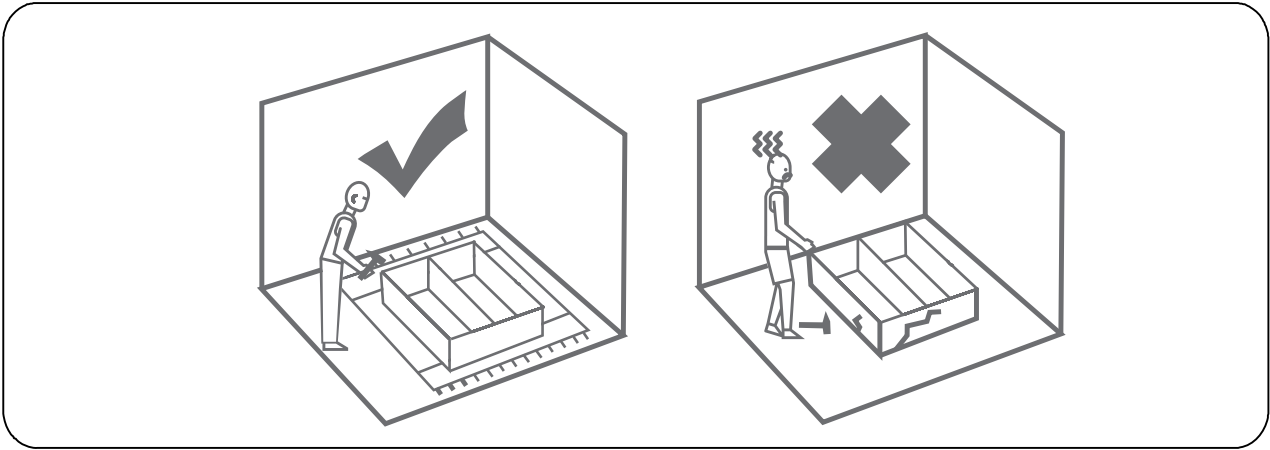
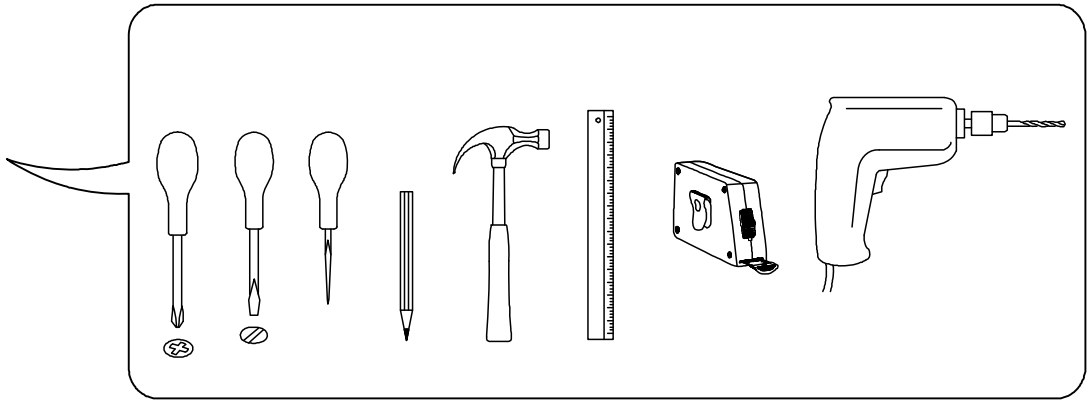

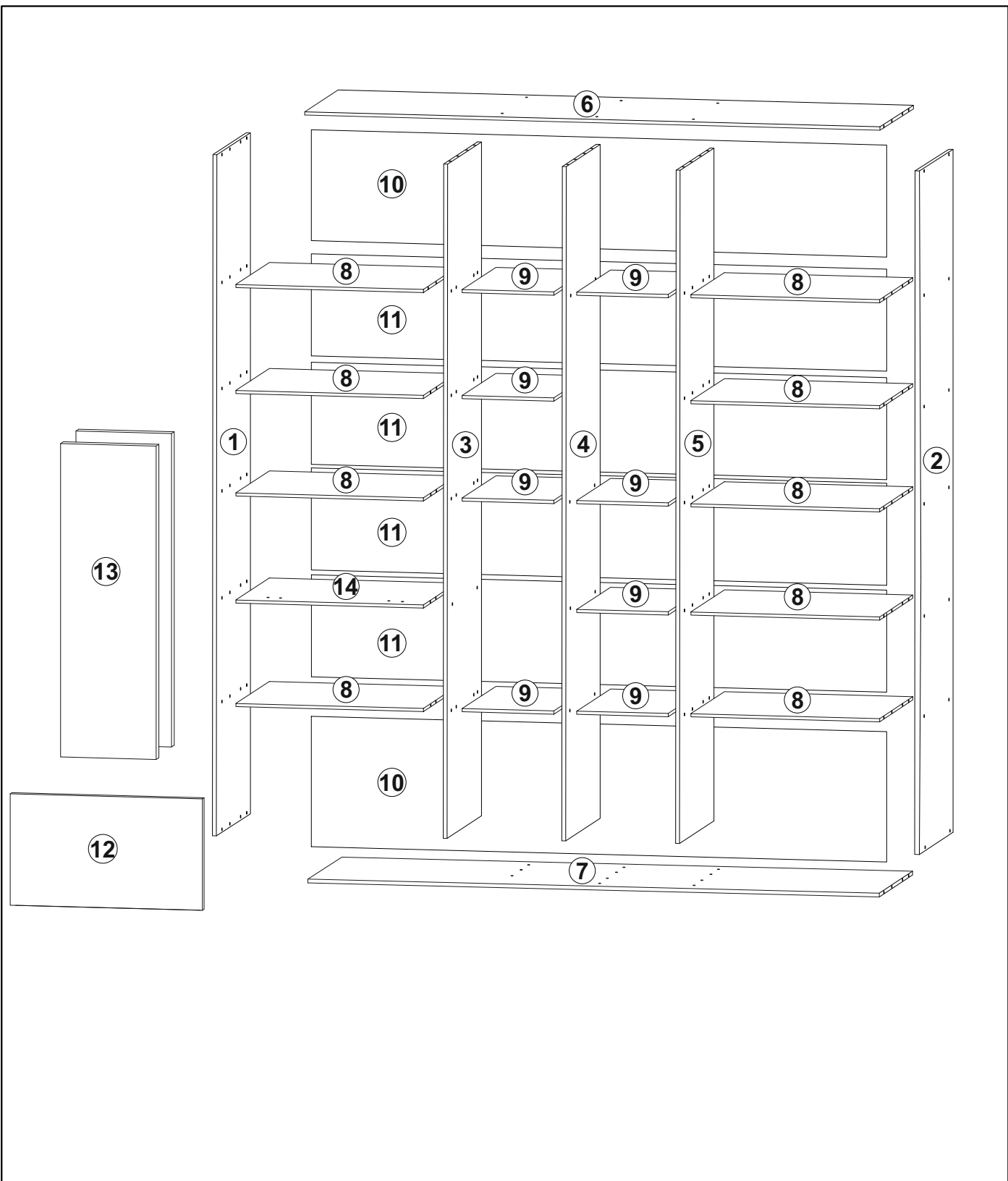

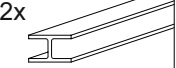

(UA)

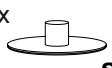
ПРАВИЛА ВИКОРИСТАННЯ ТА ДОГЛЯДУ ЗА МЕБЛЯМИ

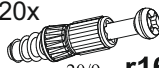
1. Використовуйте меблі тільки в сухих приміщеннях, захищених від впливу погодних умов.
2. Виконуйте установку за допомогою відповідних інструментів відповідно до даної інструкції зі складання.
3. Намагайтеся проводити збірку якомога ближче до місця використання.
4. Збірка корпусу здійснюється в горизонтальному положенні.
5. Перед переміщенням меблів переконайтеся, що вони не навантажені.
Увага: переміщення меблів може привести до її пошкодження. При переміщенні тримайтеся тільки за вертикальні елементи, переміщаючи меблі за горизонтальні деталі ви можете зламати виріб.
6. Перевантаження меблів може привести до їх пошкодження.
7. Час від часу перевіряйте кріплення і правильність їх положення.
8. Протирайте поверхню меблів тільки добре віджатою вологою тканиною або ж паперовими рушниками. Не використовуйте хімічні засоби для очищення, крім спеціально для цього призначених.



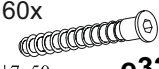

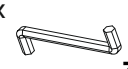
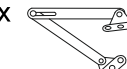
6x  56 mm	2x 	3x  40x40x15 mm n14	32x  $\phi 16$ s2	38x 
20x  20/9 r16	6x 	12x  $\phi 7 \times 13$ mm e3	 l1	122x  $\phi 3,5 \times 16$ mm p38
60x  $\phi 7 \times 50$ mm e32	60x  $\phi 8 \times 30$ mm f1	32x  $\phi 15 \times 12$ mm #16 r1	1x  z1	2x 

1

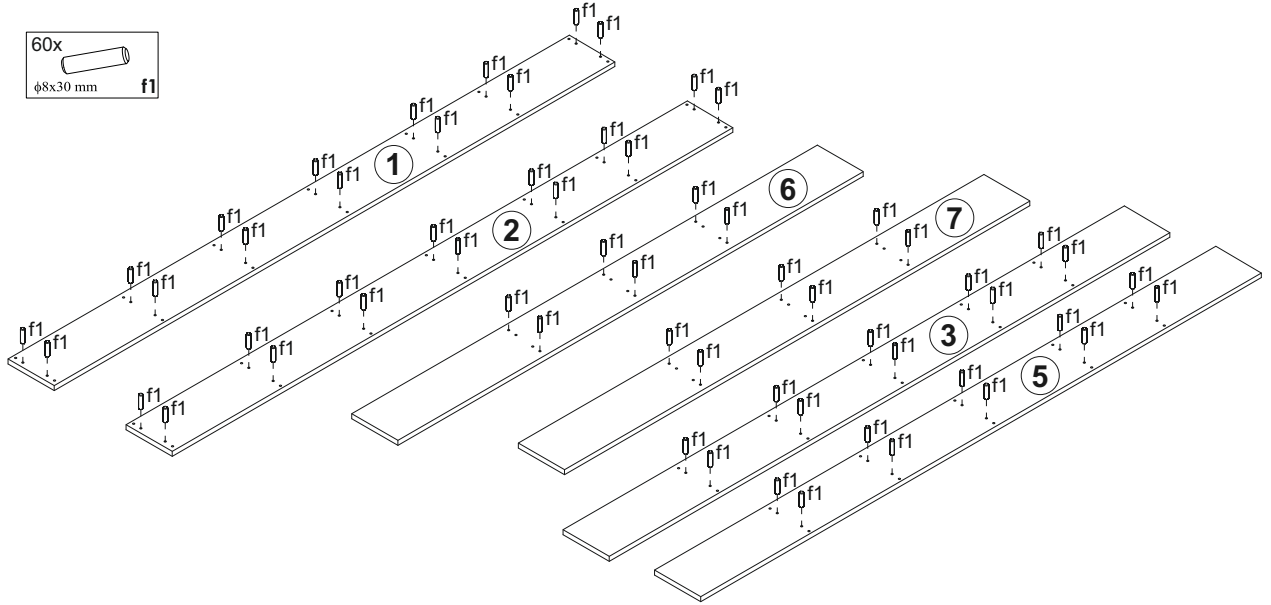

2

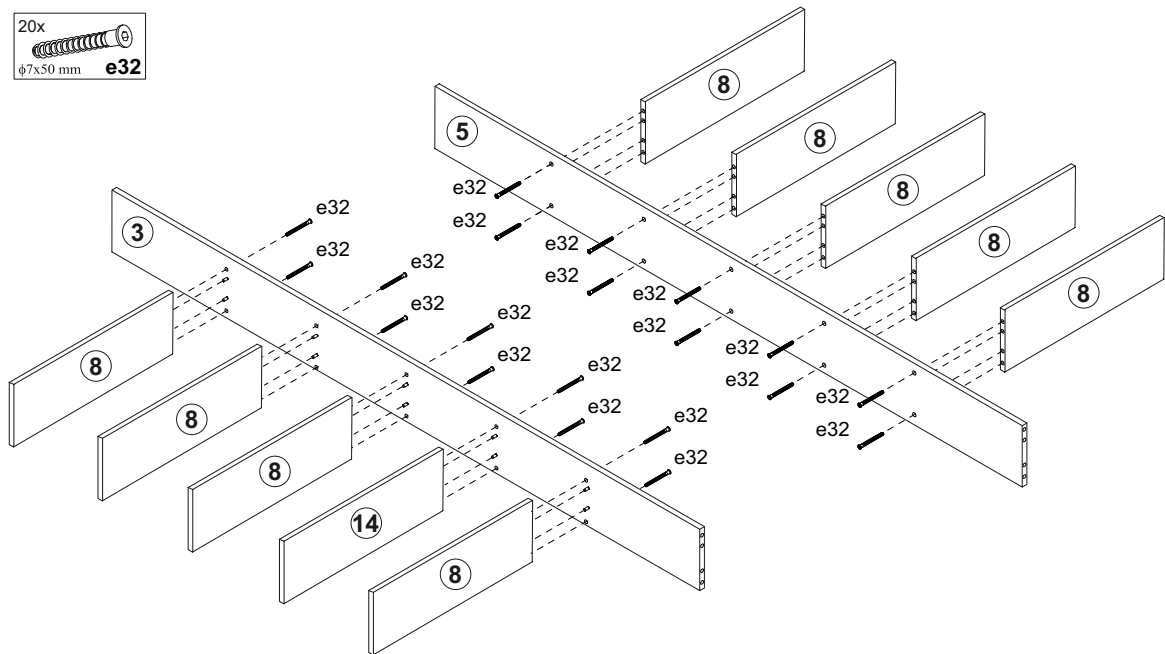
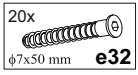

3

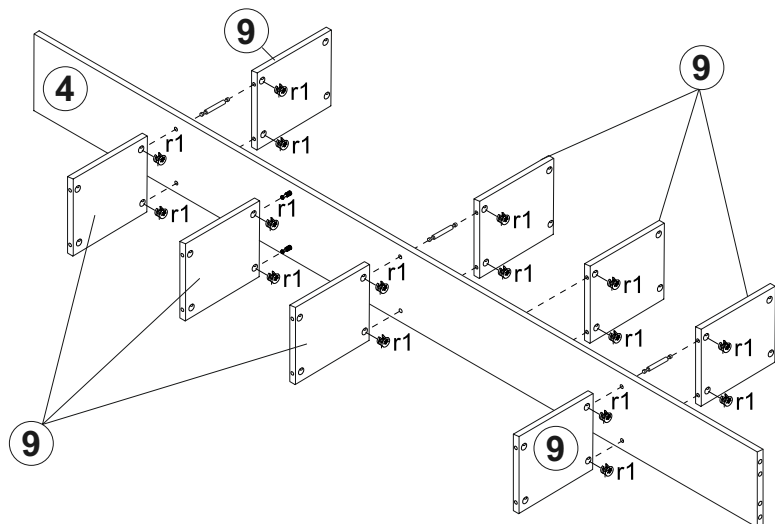
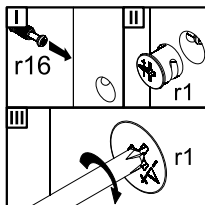
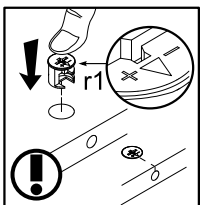
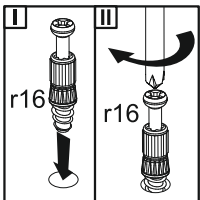
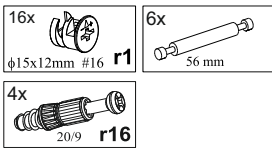

4

16x
φ15x12mm #16 r1

16x
20/9 r16

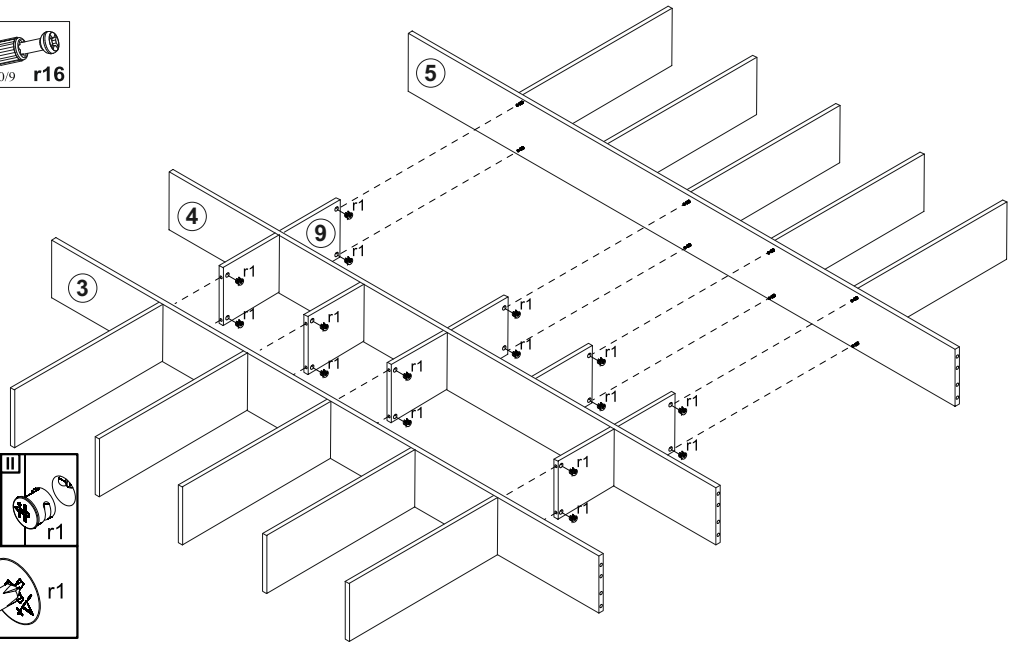
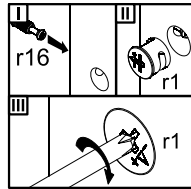
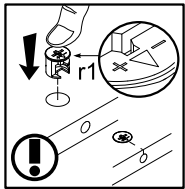
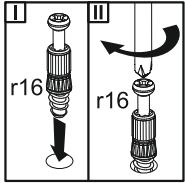

5

12x
φ7x50 mm e32

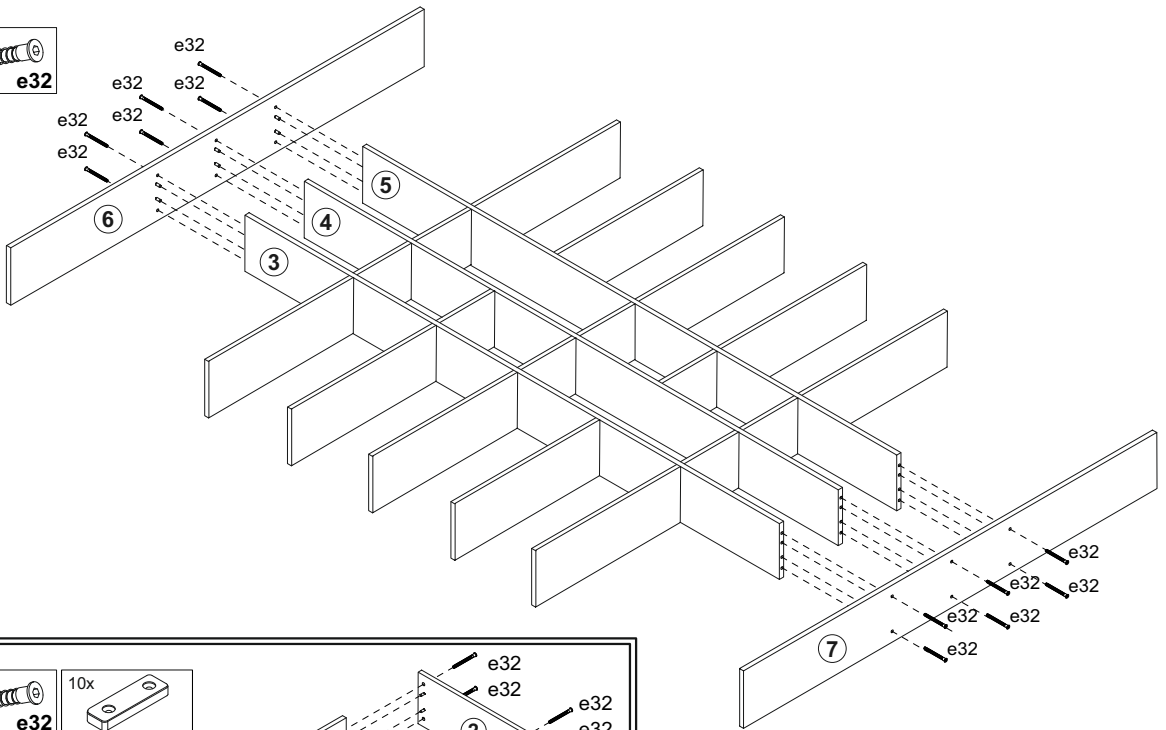

6

28x
φ7x50 mm e32

10x

20x
φ3.5x16 mm p38

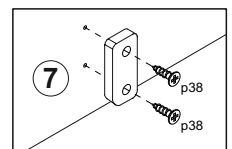
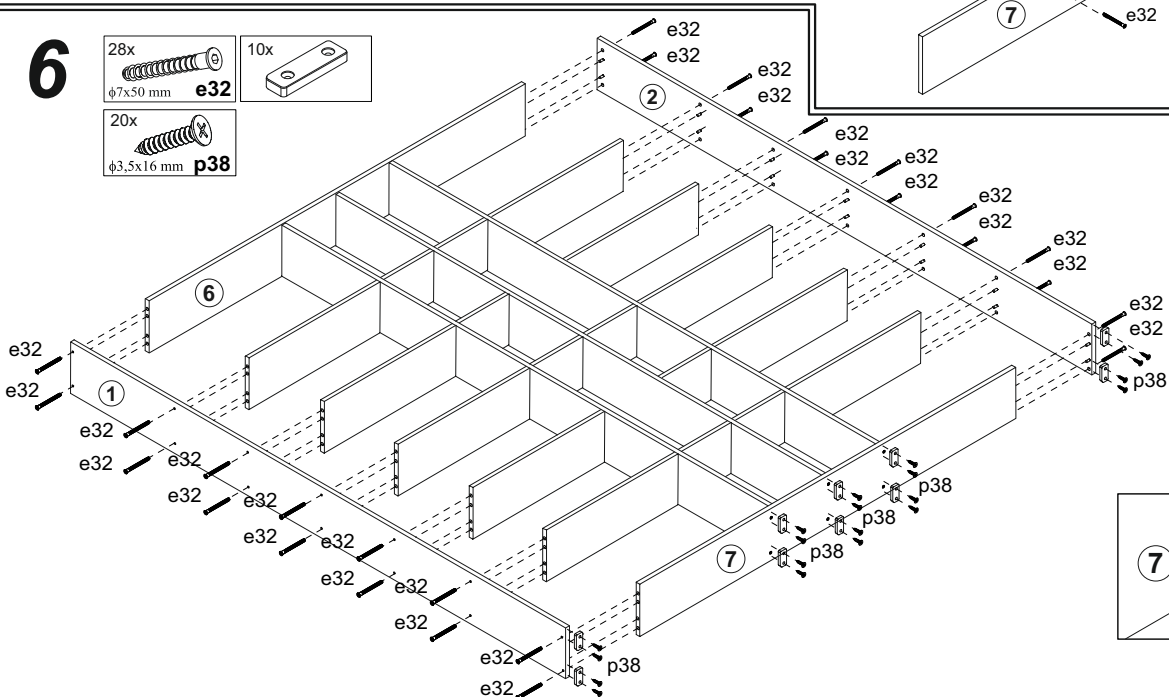

7

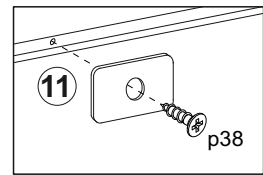
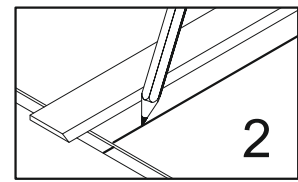
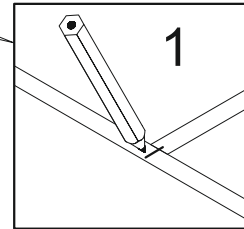
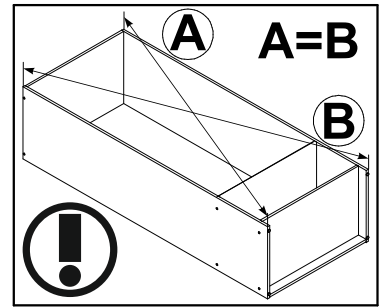
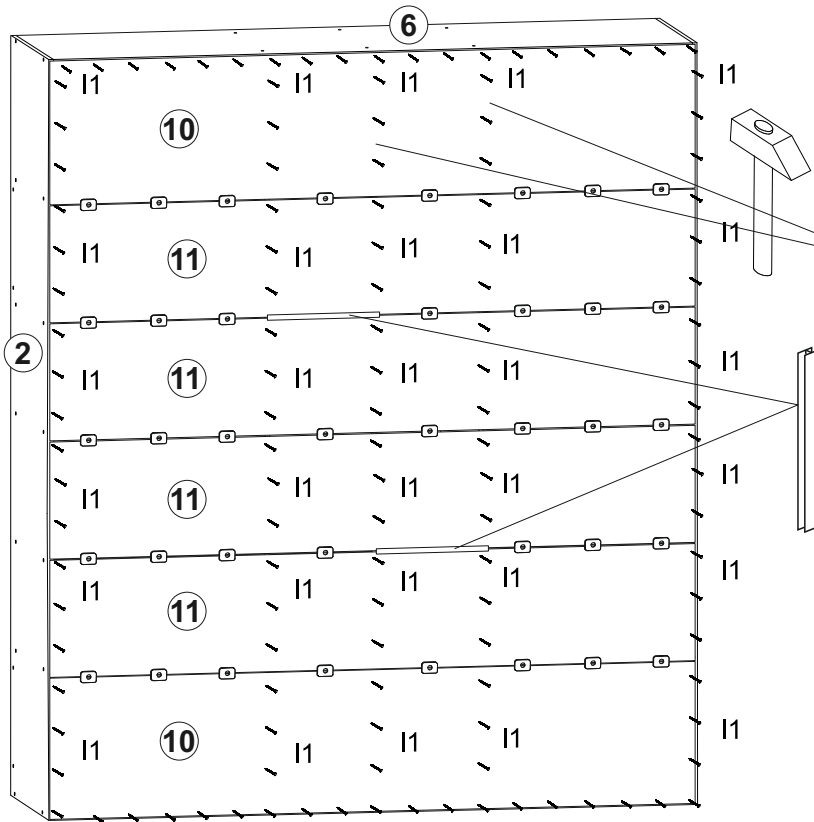
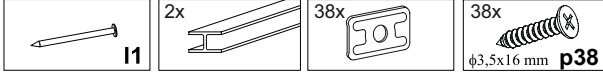

8

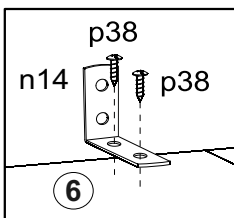
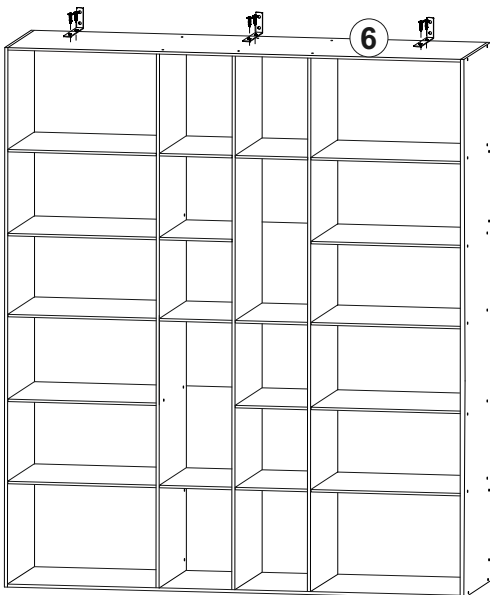
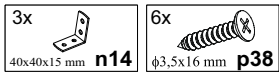

9

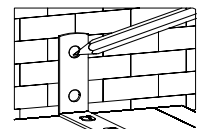
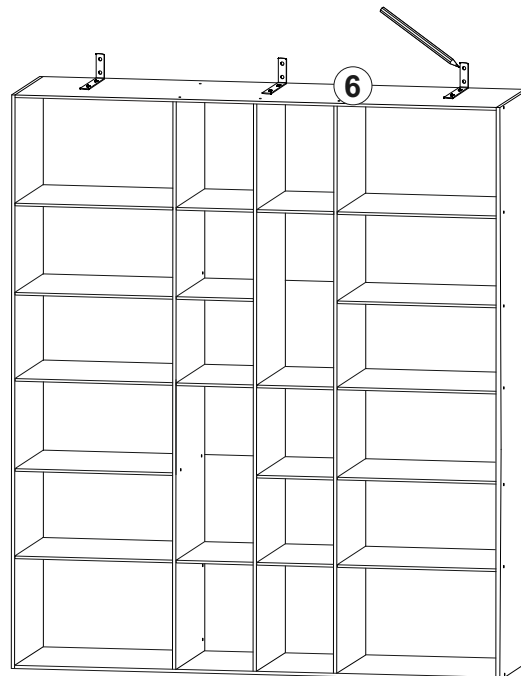

n14

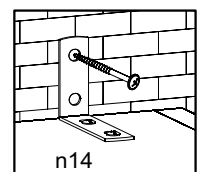
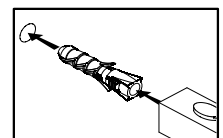
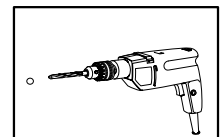

n14

10

