















PADVA 160

| | | | | | | | | | | | |
|--|--|--|---|---|---|--|---|--|---|--|---|
| K _{x24}  | L _{x24}  | M _{x12}  | N _{x4}  | O _{x6}  | P _{x26} M8x30mm  | Q _{x4} M4x25mm  | R _{x26} M8x40mm  | S _{x26} M8  | T _{x8}  | U _{x26}  | V _{x1}  |
|--|--|--|---|---|---|--|---|--|---|--|---|

| | |
|---|---|
| W _{x1}  | X _{x4}  |
|---|---|

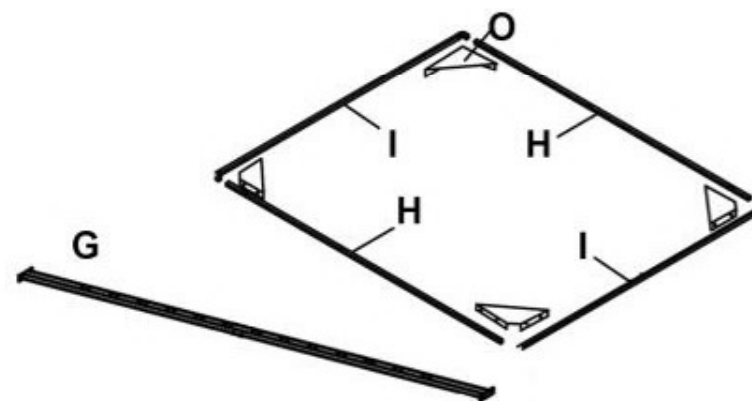
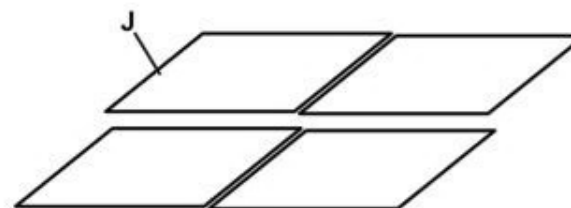
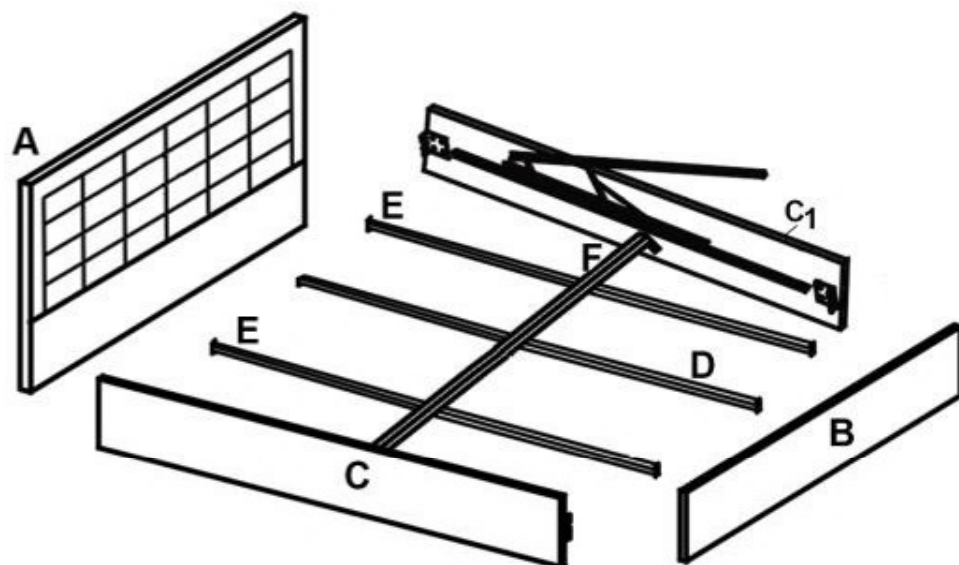

v.2

PADVA 160

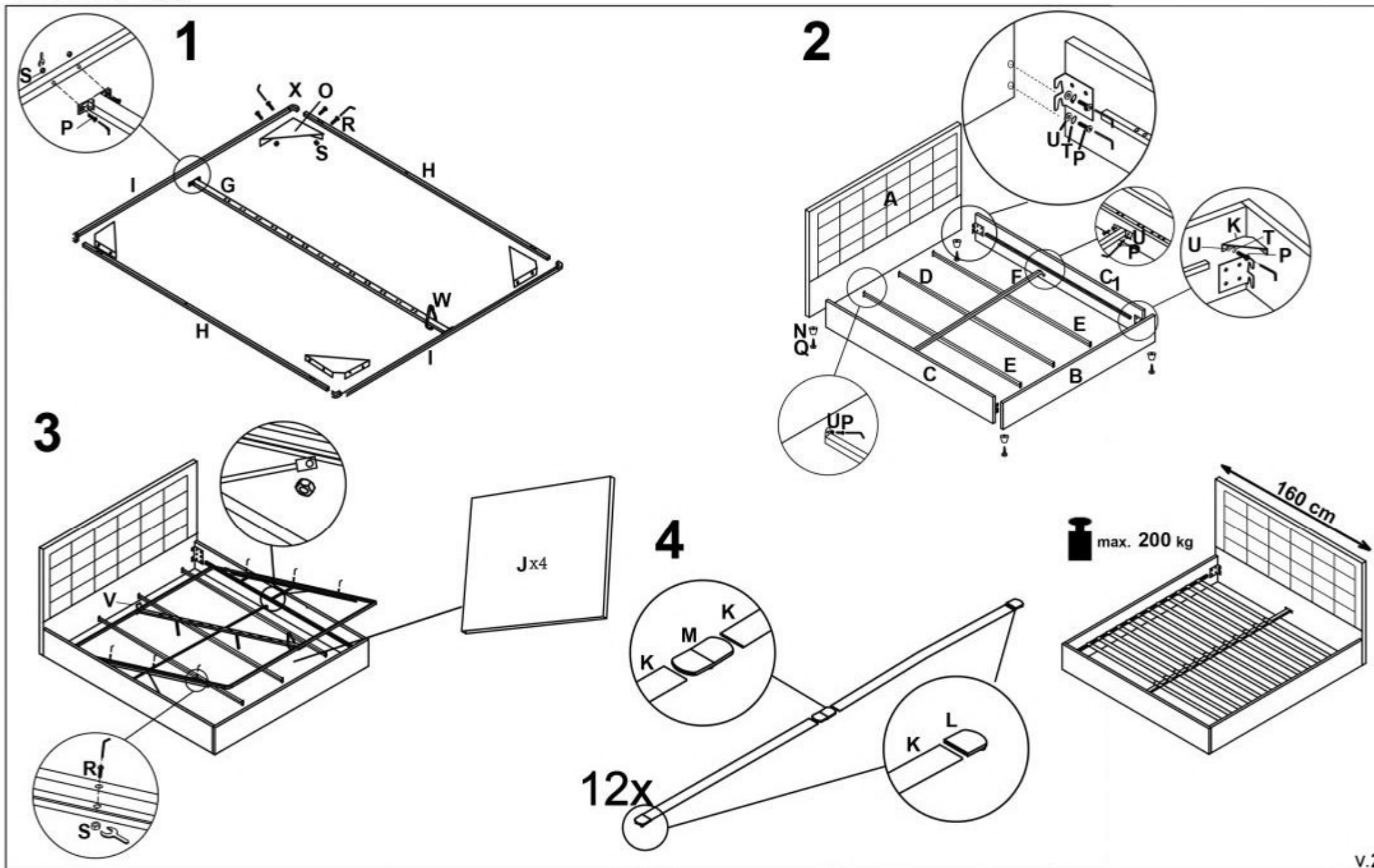

v.2