

2040x1350x464 mm

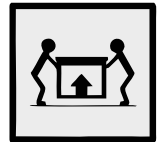
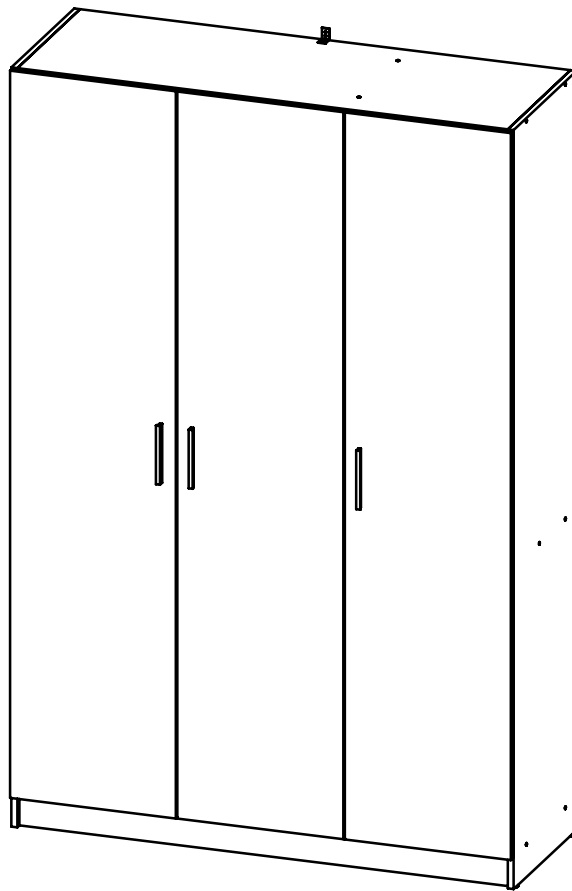

ENG

RULES FOR USE AND CARE OF FURNITURE

1. Use furniture only in dry rooms protected from the effects of weather conditions.
2. Install with suitable tools according to these assembly instructions.
3. Try to assemble as close to the location as possible.
4. The body is assembling in a horizontal position.
5. Before moving furniture, make sure that it is not loaded with items.

Caution: moving furniture may damage it.
When moving, hold on to vertical elements only; moving furniture by horizontal parts can break the product.

6. Overloading the furniture can damage it.
7. From time to time check the fittings and their correct position.
8. Wipe the furniture surface only with a slightly damp cloth or paper towels. Do not use chemical cleaning agents other than those specifically made for this.

UA

ПРАВИЛА ВИКОРИСТАННЯ ТА ДОГЛЯДУ ЗА МЕБЛЯМИ



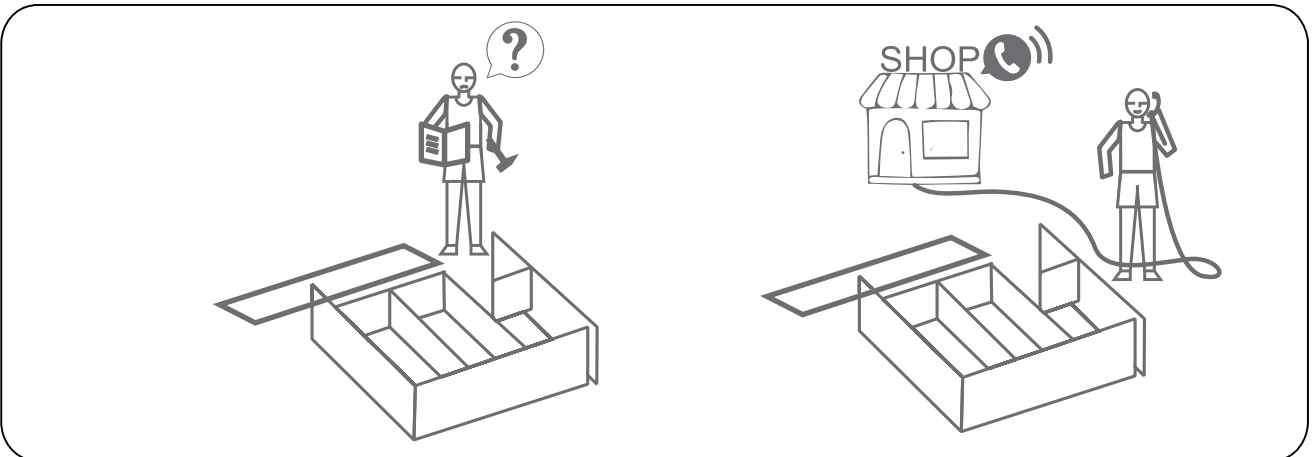
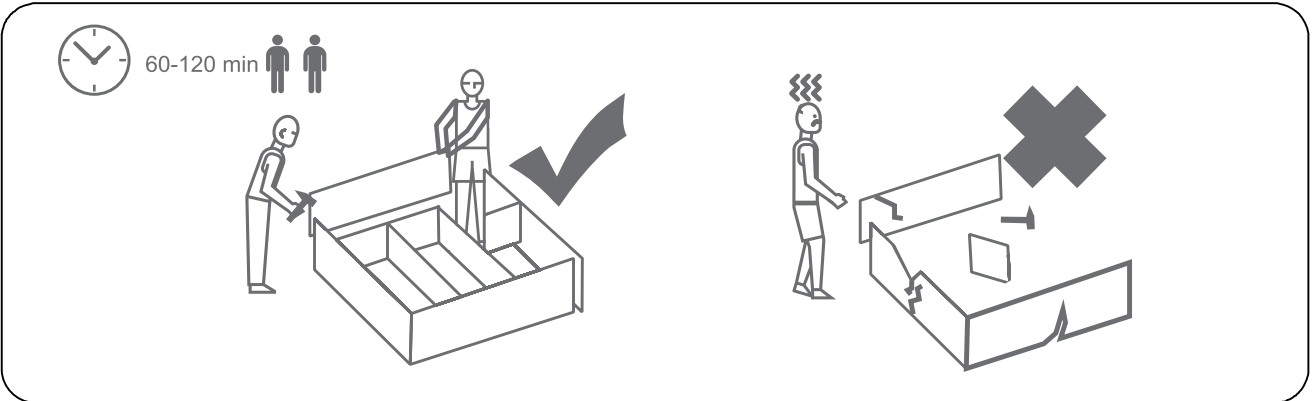
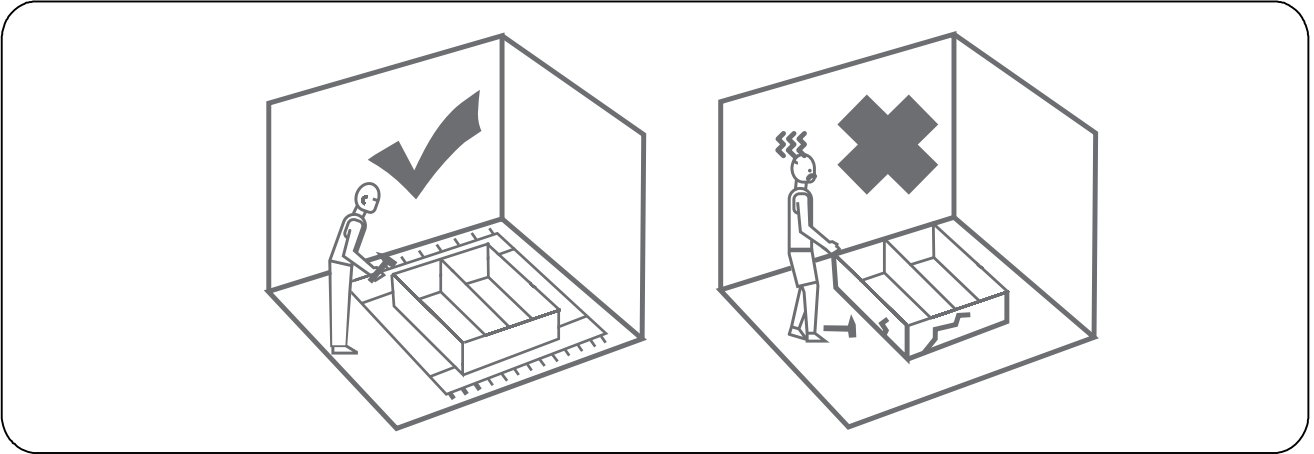
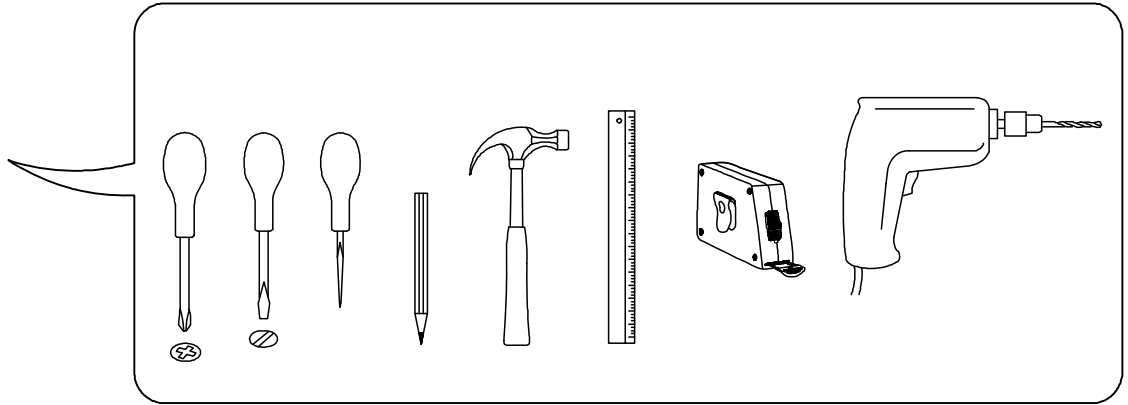

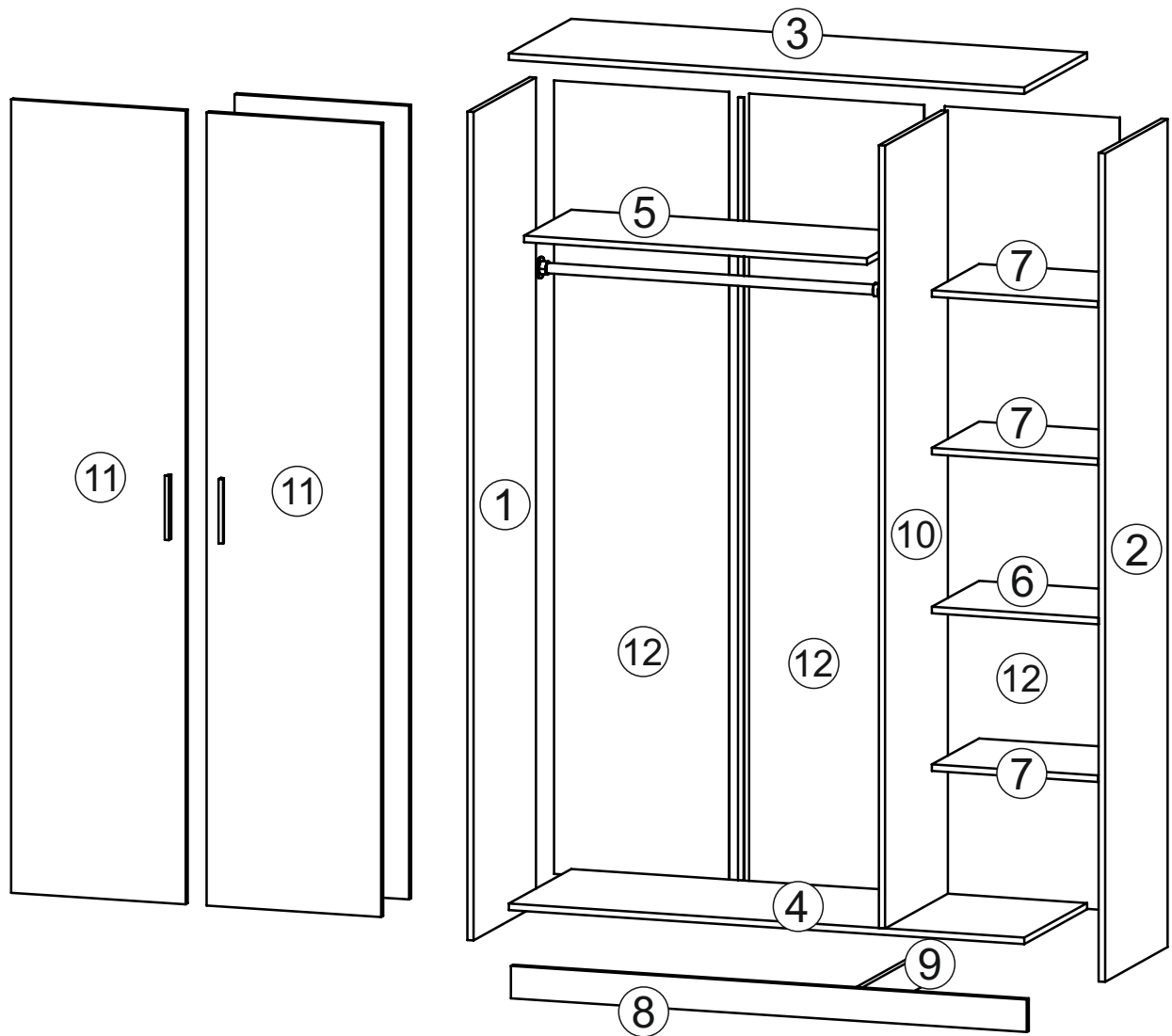

1. Використовуйте меблі тільки в сухих приміщеннях, захищених від впливу погодних умов.
2. Виконуйте установку за допомогою відповідних інструментів відповідно до даної інструкції зі складання.
3. Намагайтеся проводити збірку якомога ближче до місця використання.
4. Збірка корпусу здійснюється в горизонтальному положенні.
5. Перед переміщенням меблів переконайтеся, що вони не навантажені.
Увага: переміщення меблів може привести до її пошкодження.
При переміщенні тримайтеся тільки за вертикальні елементи, переміщаючи меблі за горизонтальні деталі ви можете зламати виріб.
6. Перевантаження меблів може привести до їх пошкодження.
7. Час від часу перевіряйте кріплення і правильність їх положення.
8. Протирайте поверхню меблів тільки добре віджатою вологою тканиною або ж паперовими рушниками. Не використовуйте хімічні засоби для очищення, крім спеціально для цього призначених.



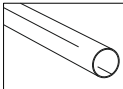
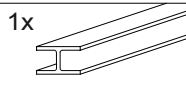

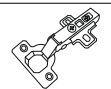
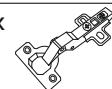
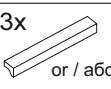
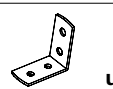
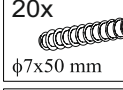
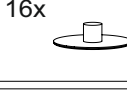
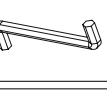
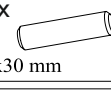
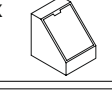
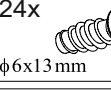
№	size / розмір		pack / уп.	qty / к-ть
1	2040	464	1/2	1
2	2040	464	1/2	1
3	1318	464	1/2	1
4	1318	464	1/2	1
5	876	350	1/2	1
6	426	350	1/2	1

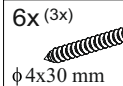
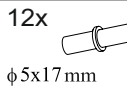
№	size / розмір		pack / уп.	qty / к-ть
7	425	350	1/2	3
8	1318	80	1/2	1
9	432	80	1/2	1
10	1928	464	2/2	1
11	1954	446	2/2	3
12	1954	447	2/2	3

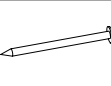
 1x	 1x	 2x n906	 8x D	 4x E	 3x or / або	 1x u1
 20x φ7x50 mm e32	 16x s3	 1x z1	 20x φ8x30 mm f1	 7x c3	 24x φ6x13 mm e3	 53x φ3,5x16 mm p38
 6x (3x) φ4x30 mm p41	 12x φ5x17 mm d1	 6x k1	 l1			

1

20x
φ8x30 mm **f1**

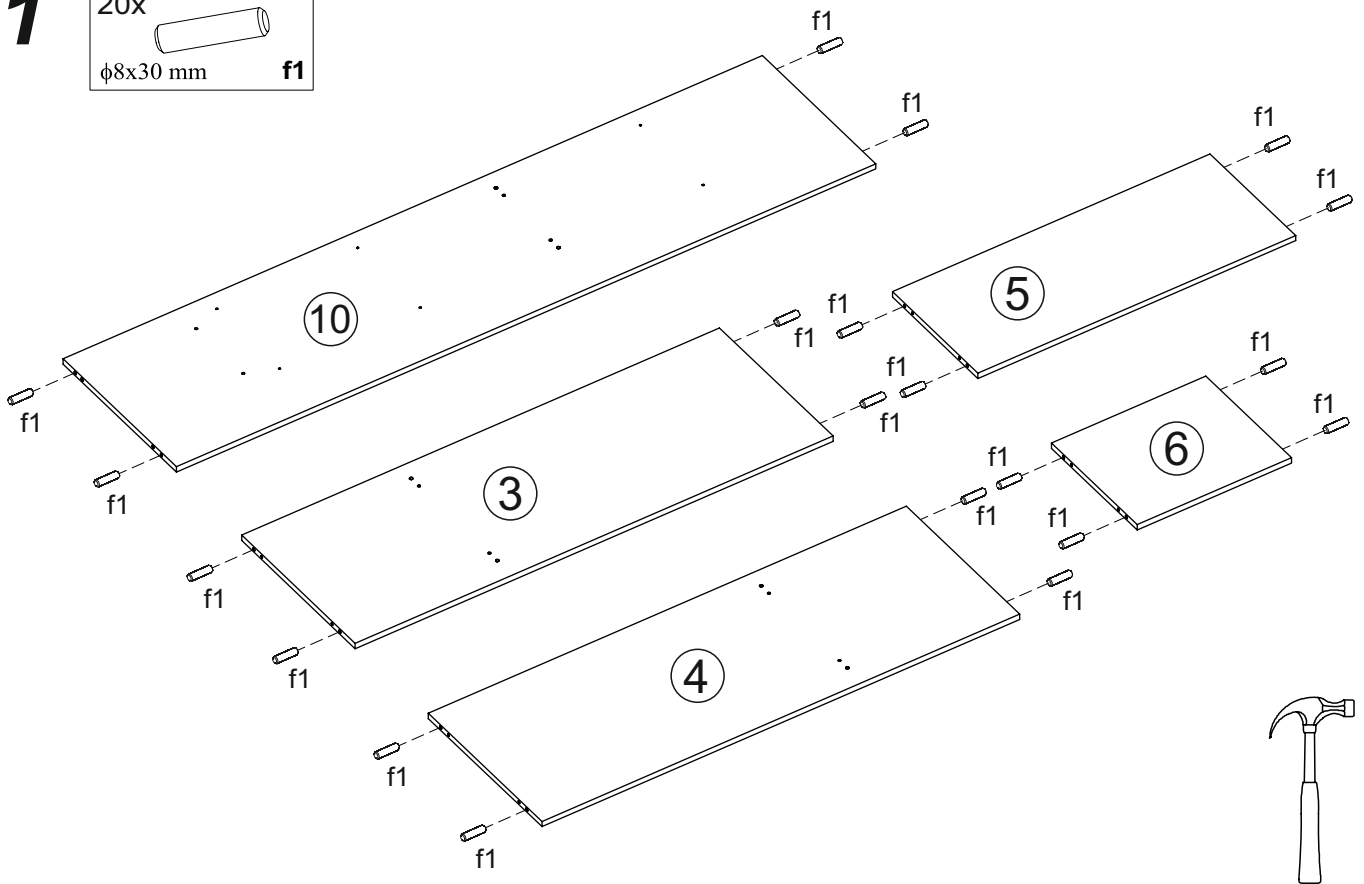

2

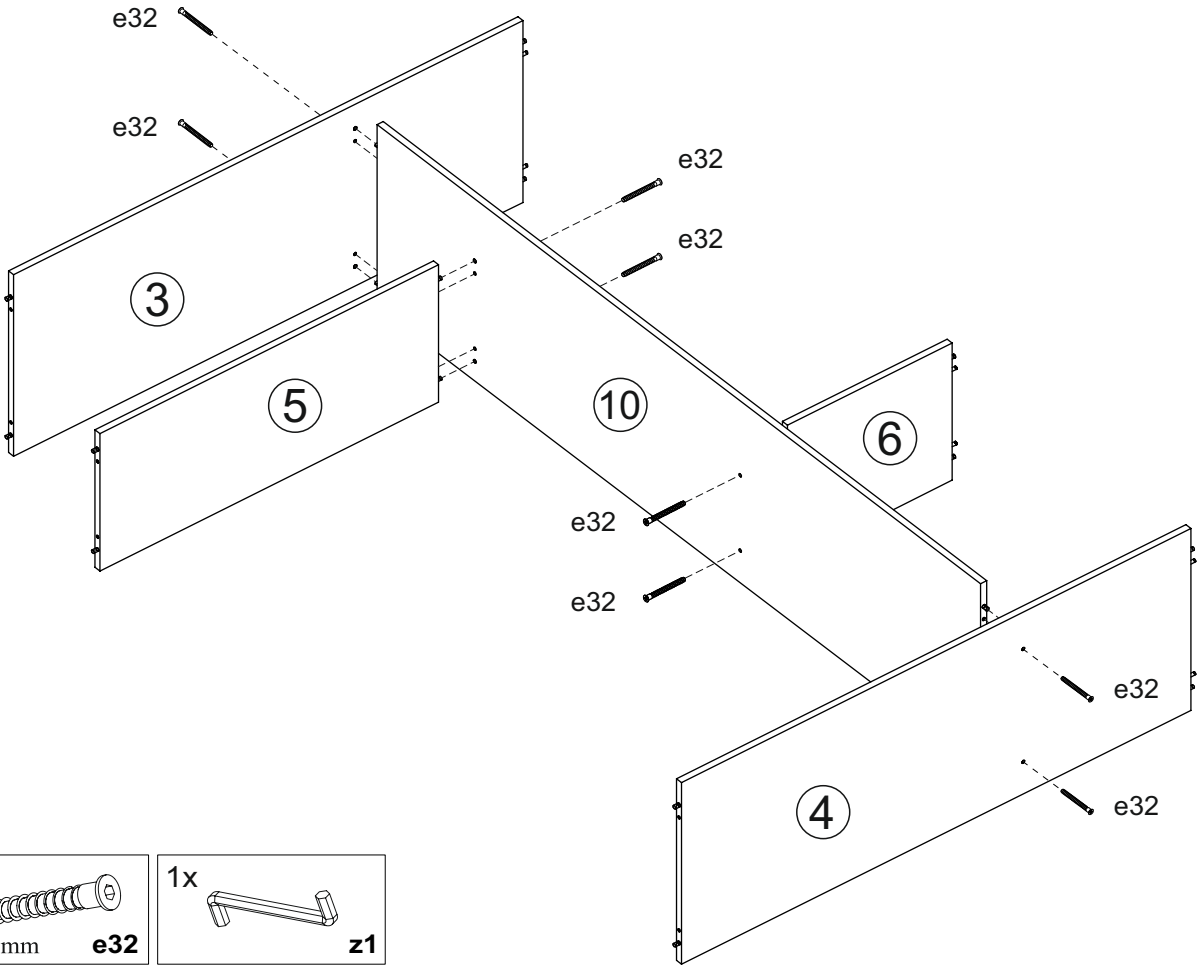

8x
φ7x50 mm **e32**

1x
z1

3

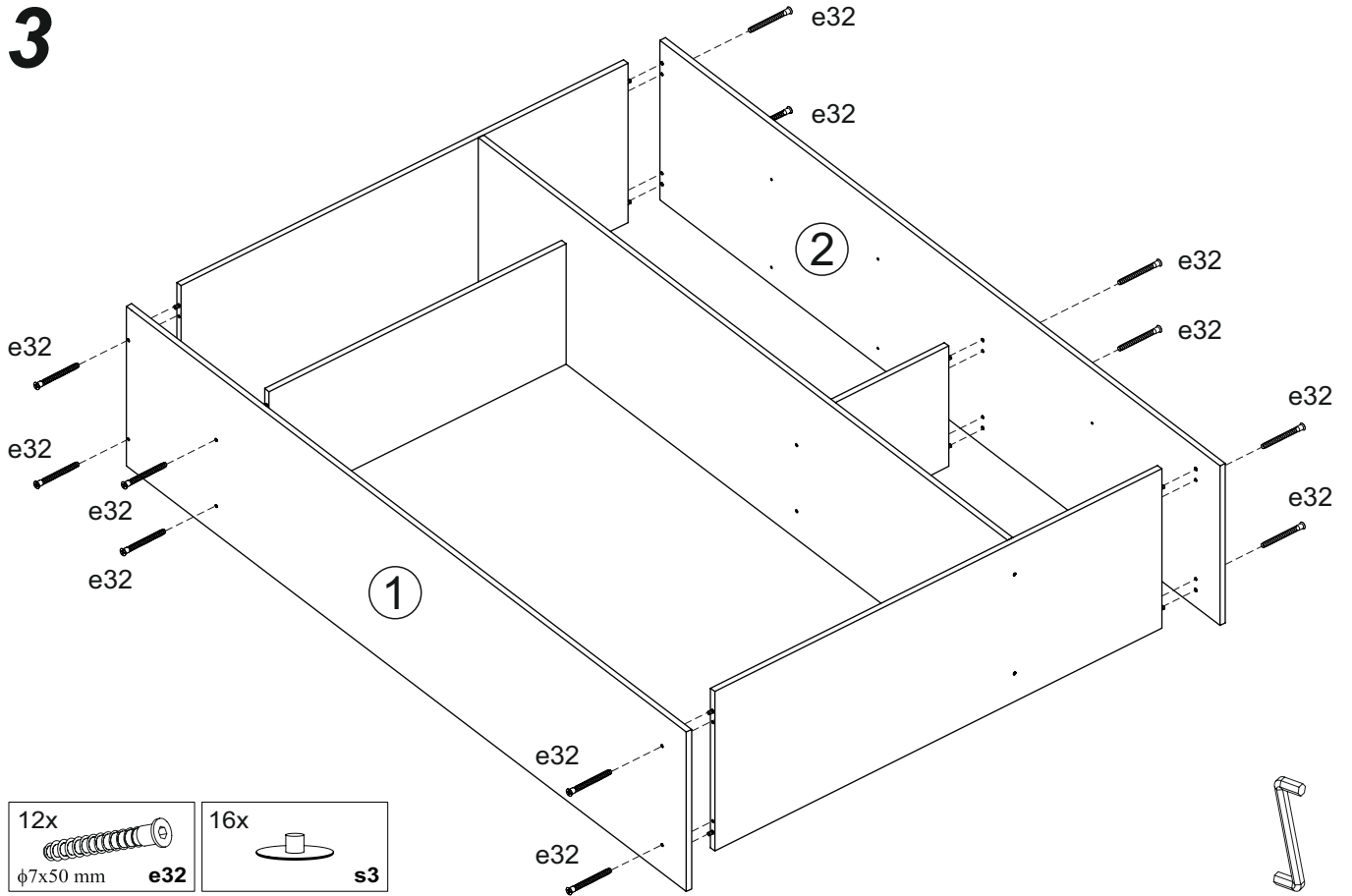

4

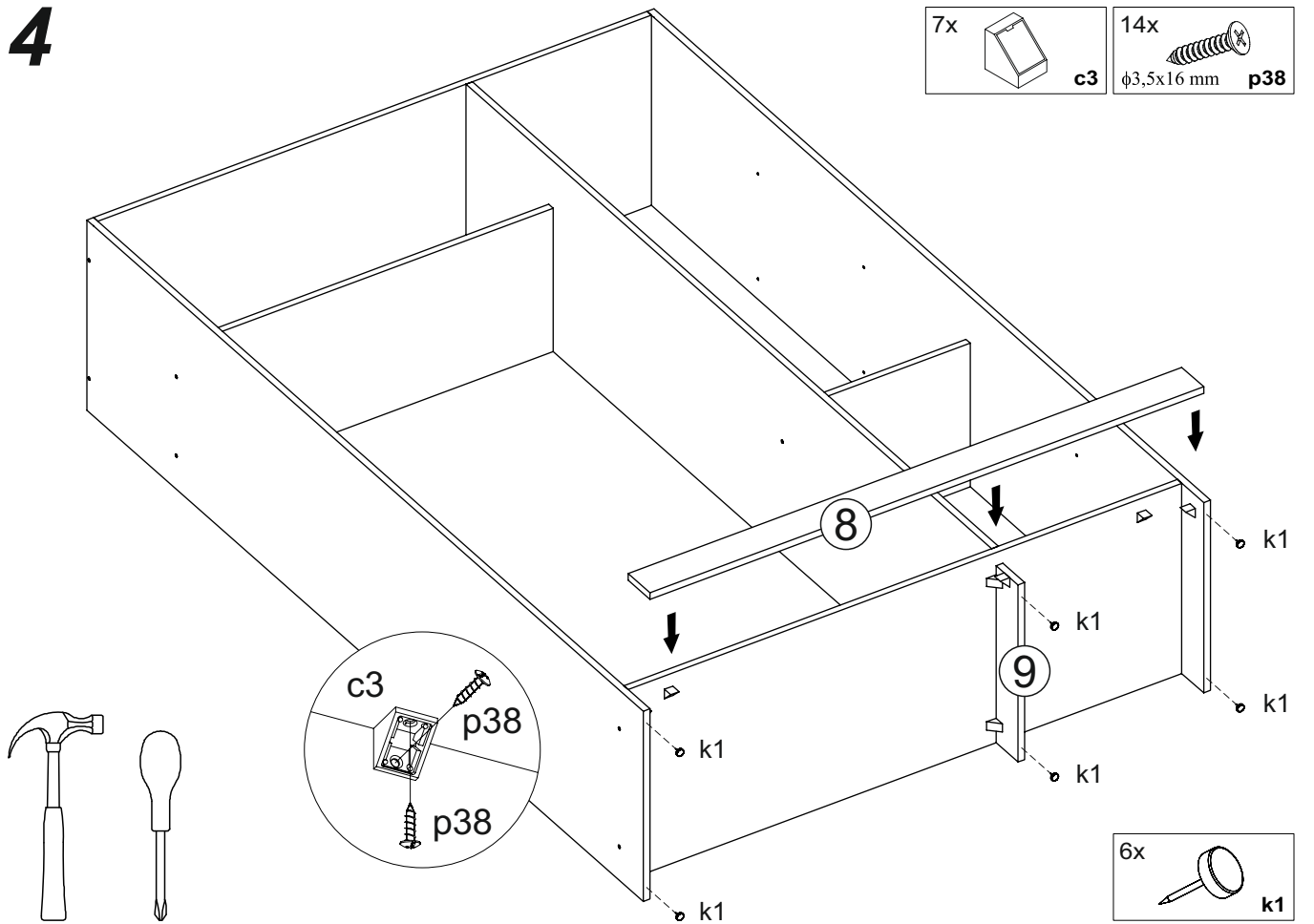

5

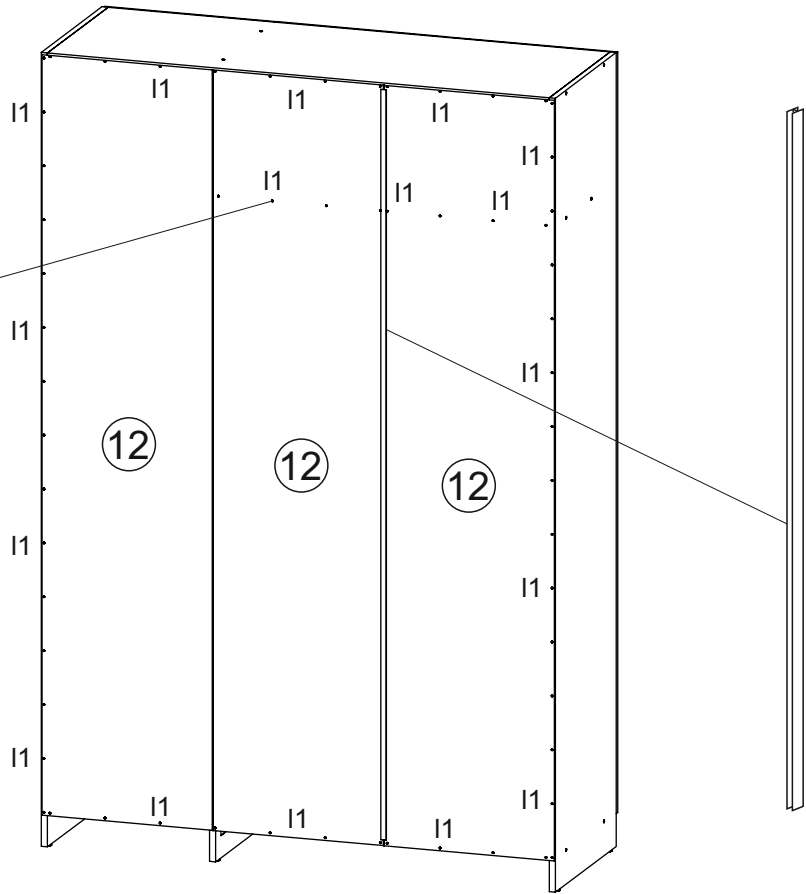
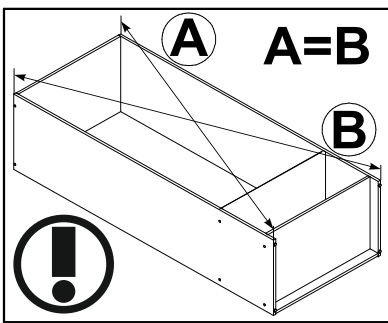
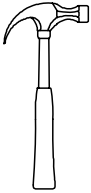
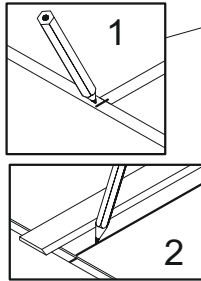
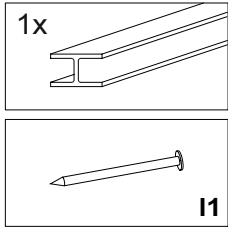

6

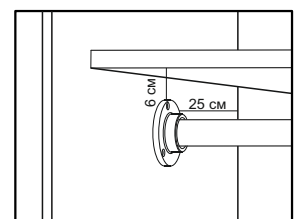
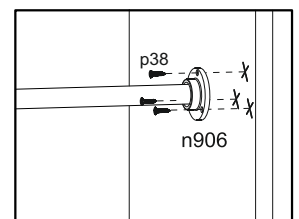
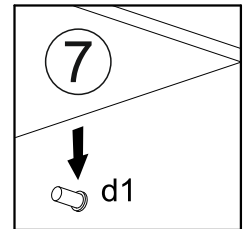
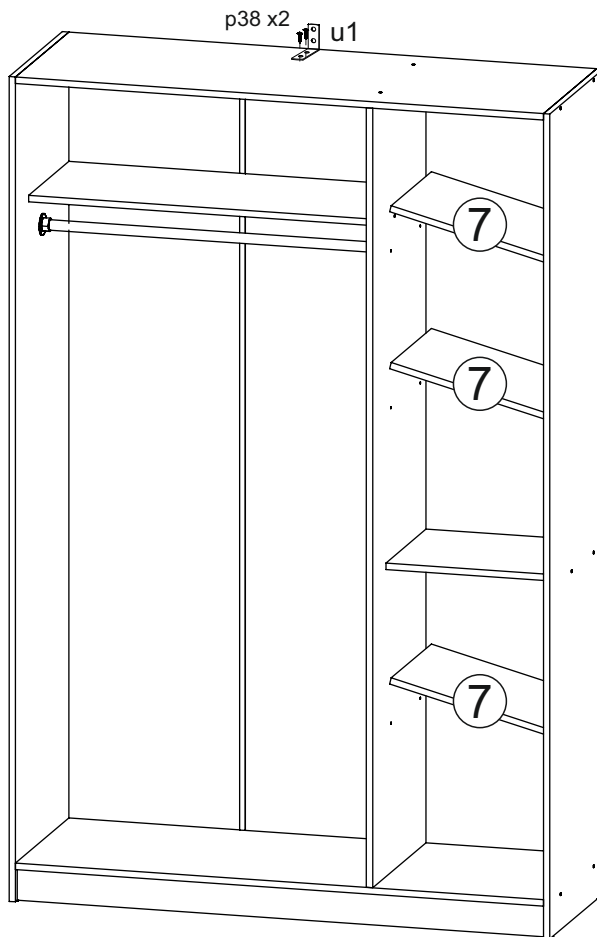
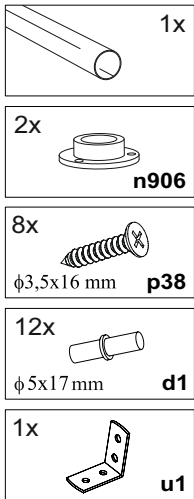

ENG
The dowels are not included.
Purchase separately.

UA
Дюбелі в комплект не входять.
Необхідно придбати окремо.

7

