

Do montazu potrzebne są:
Für die Montage dieser Type benötigen Sie:

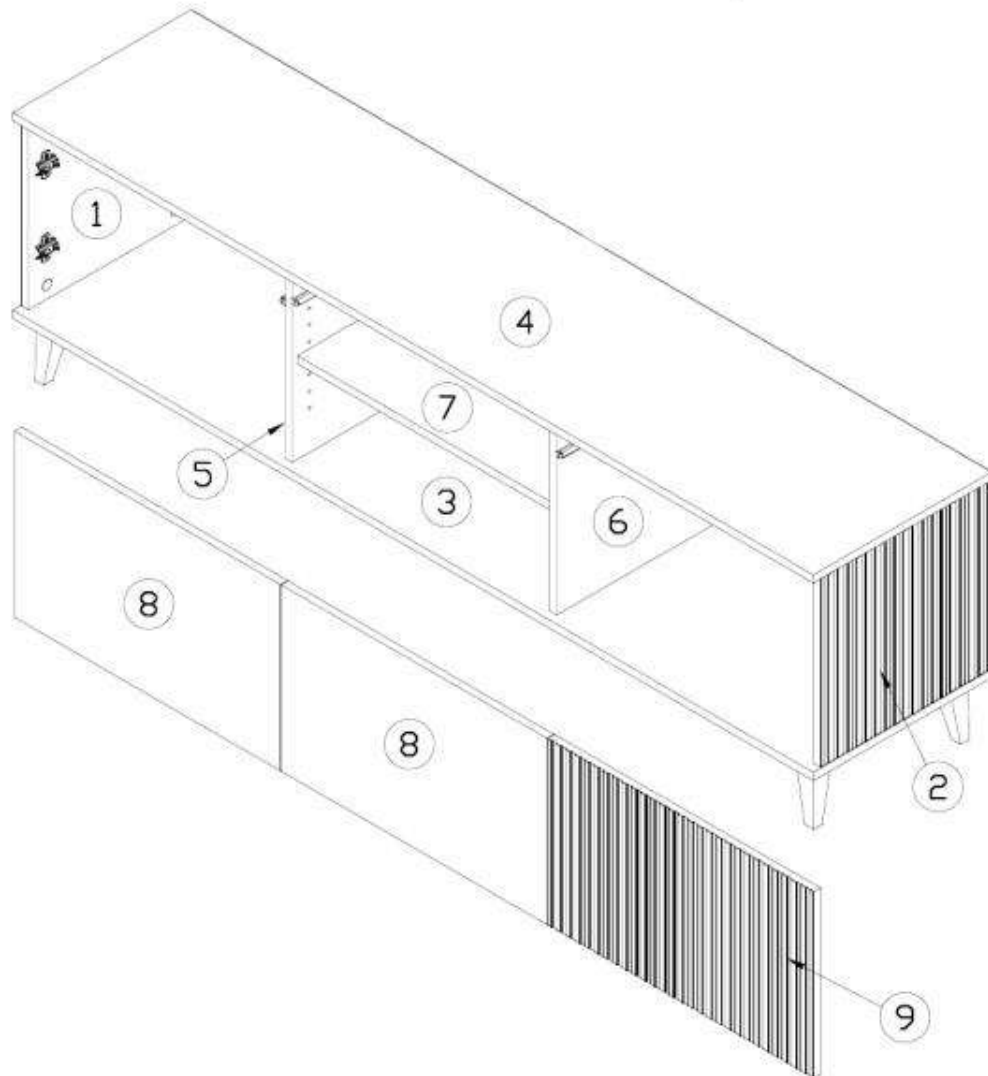

PL INSTRUKCJA MONTAŻOWA
D MONTAGEANLEITUNG
GB ASSEMBLY INSTRUCTIONS

D Sehr geehrter Kunde, sollte ein Teil fehlen oder beschädigt sein, kreuzen Sie bitte dieses deutlich auf der Montageanleitung an und schicken Sie zu uns ab.
GB Dear customer, Should there be any place missing or damaged, kindly mark this place clearly on the attached assembly instructions and return it to us.
PL Szanowny Kliencie, gdyby brakowało jakiejś części lub byłaby uszkodzona proszę to oznaczyć krzyżykiem na instrukcji montażowej i przesać instrukcję razem z reklamacją.

Uwagi pielęgnacyjne!
Proszę wycierać ściereczką do kurzu lub lekko wilgotną ścierką. Nie stosować **ŻADNYCH** środków rysujących powierzchnie.
Pflegehinweis!
Bitte nur mit einem Staubtuch oder einem fauchtem Lappen reinigen. **KEINE** scheuernde Putzmittel verwenden!

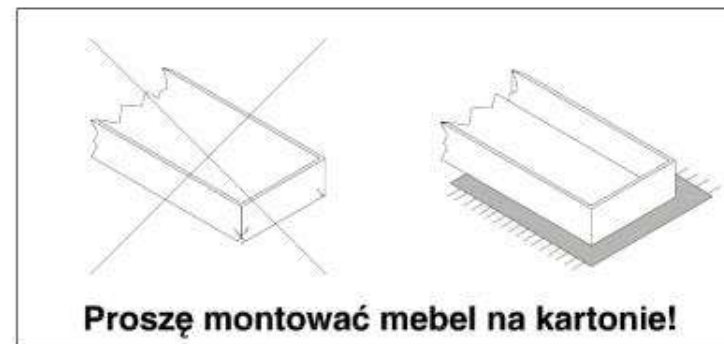

BAG 1

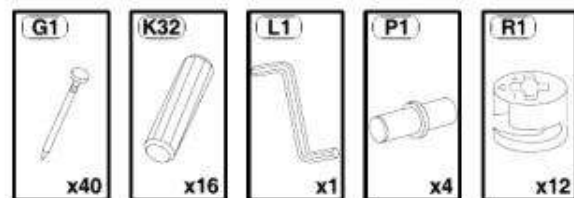

BAG 2

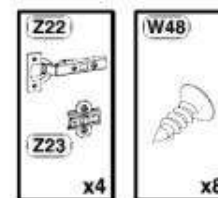

BAG 3

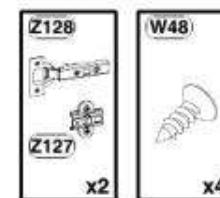

BAG 4

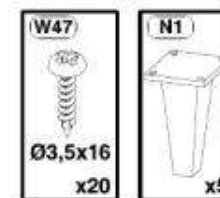

BAG 5



1

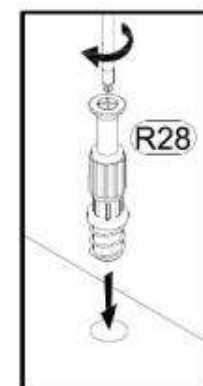
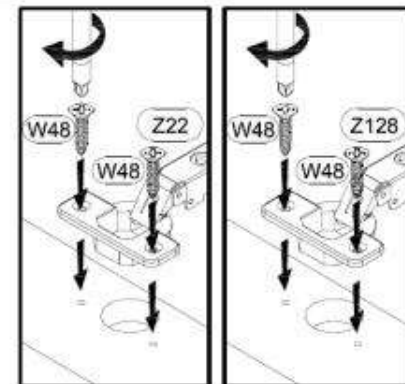
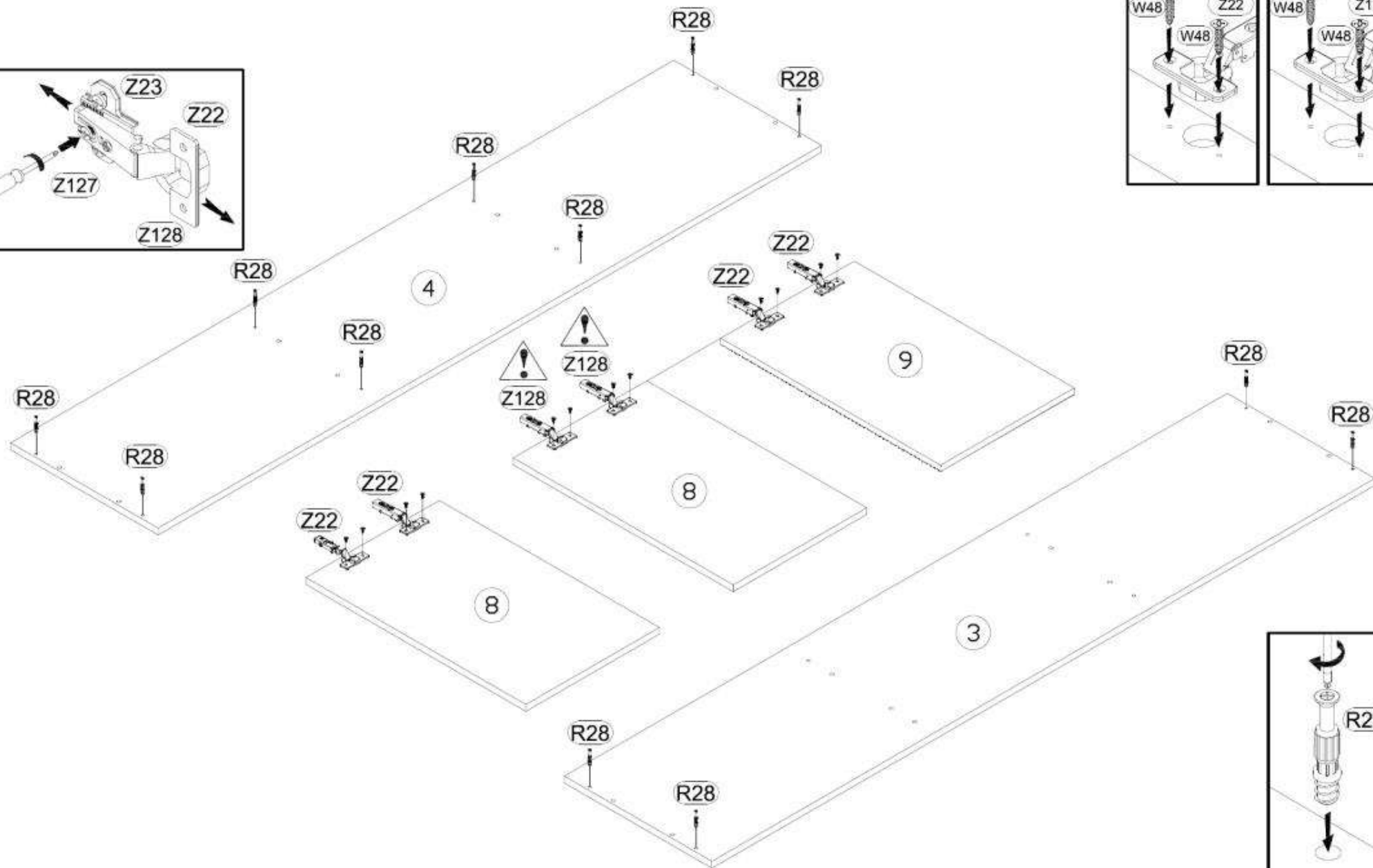
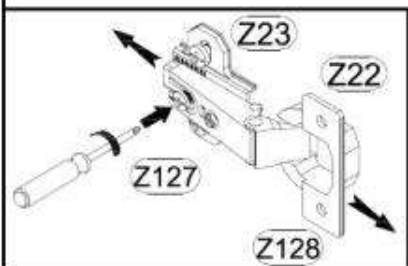

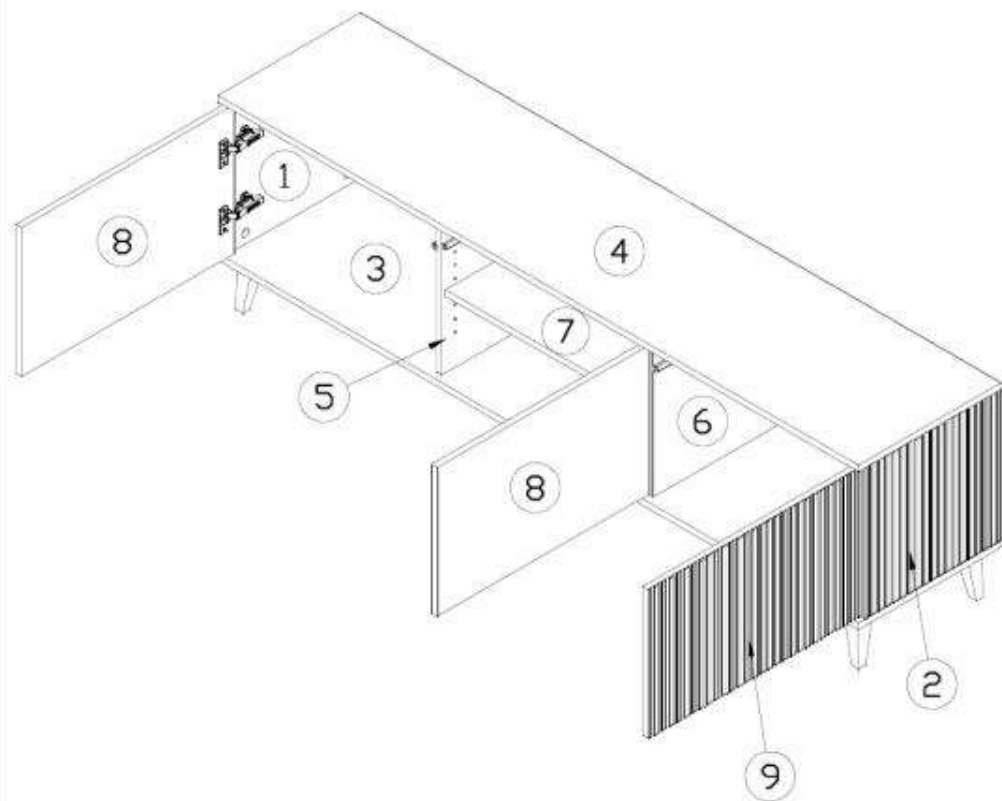

"RIGHT" 2-5

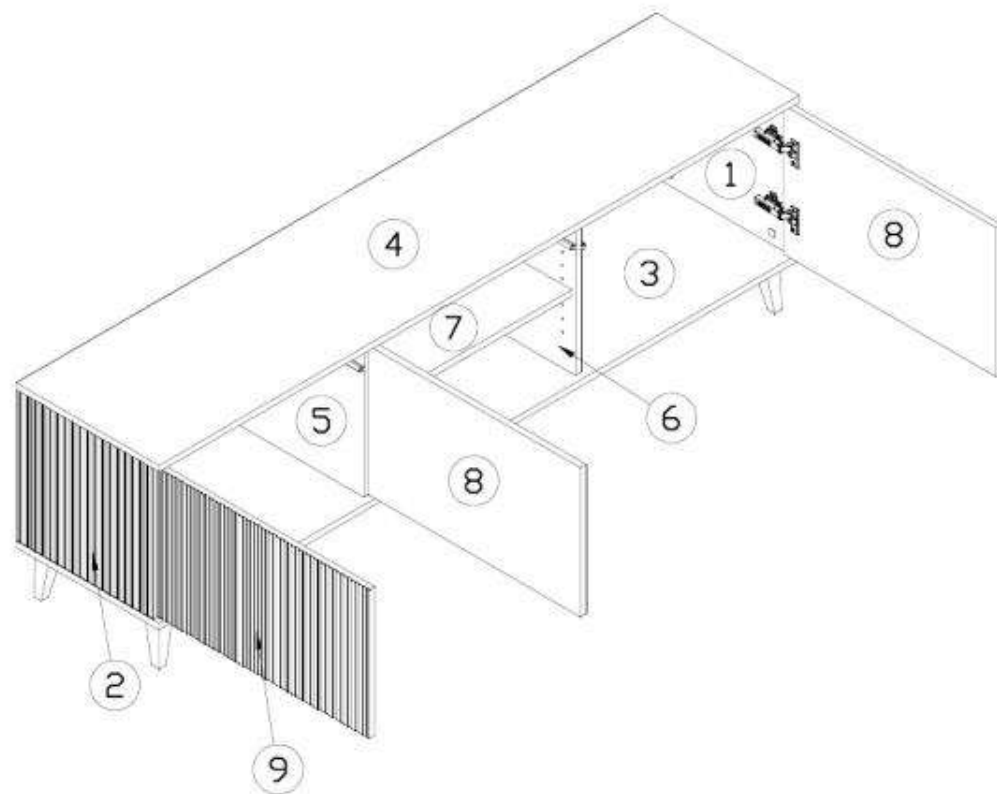

"LEFT" 6-9

2

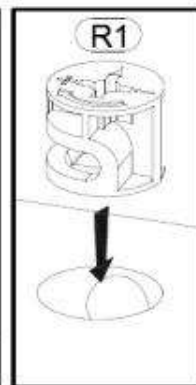
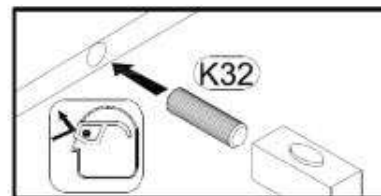
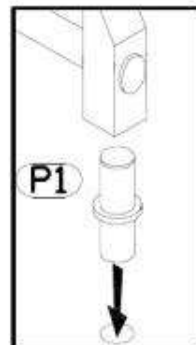
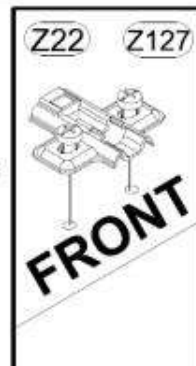
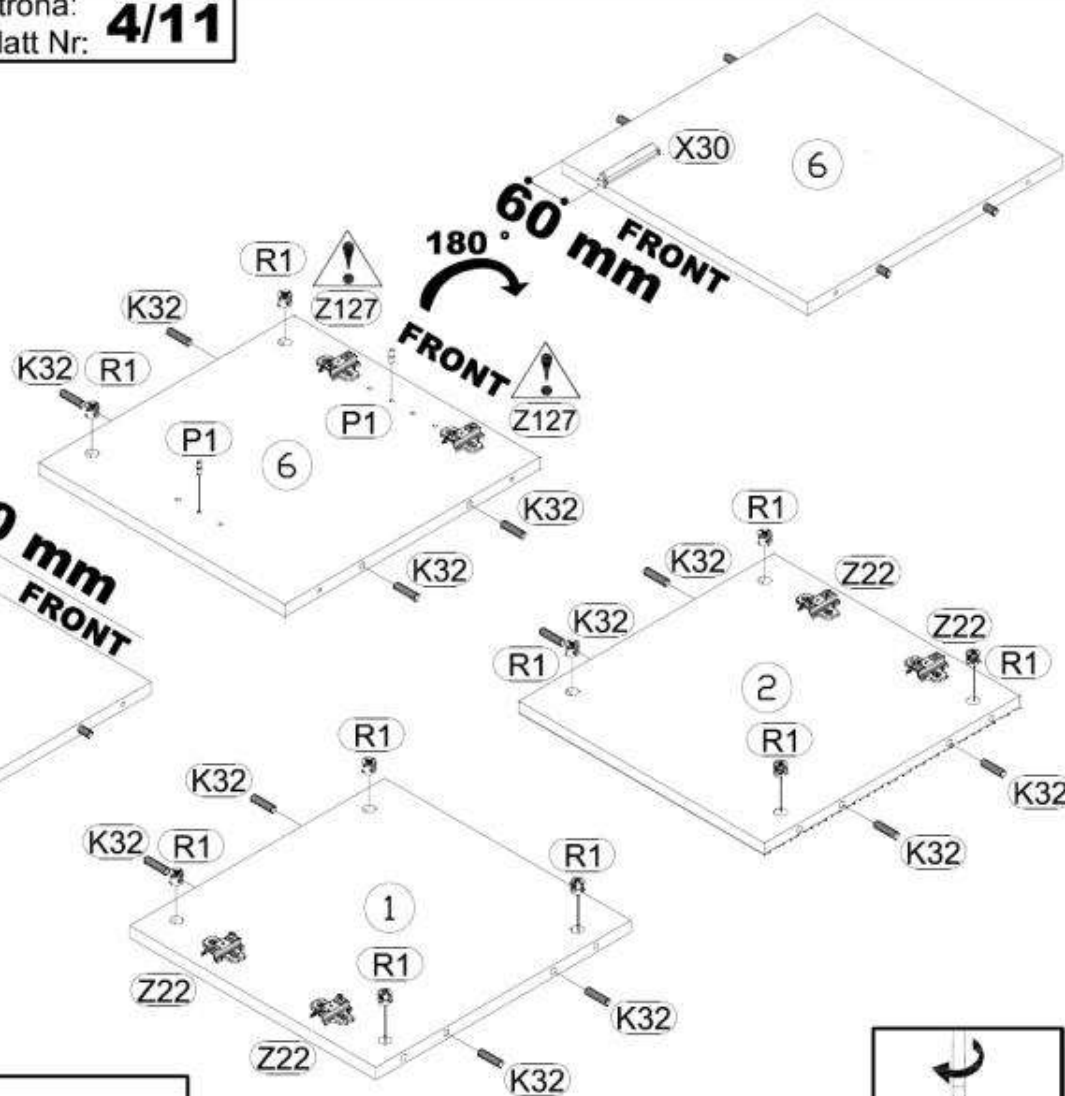
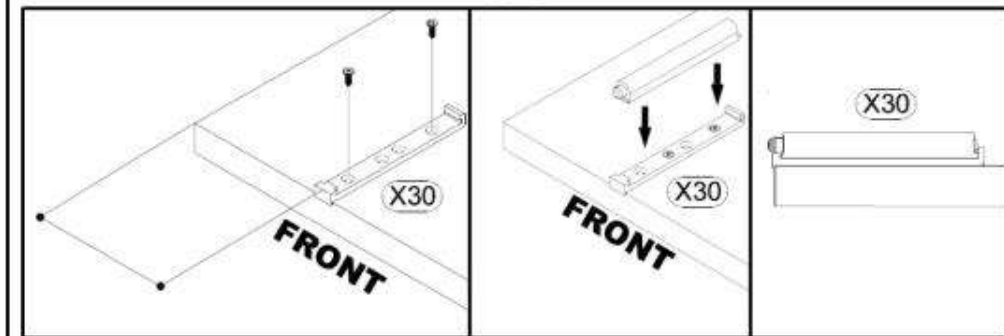
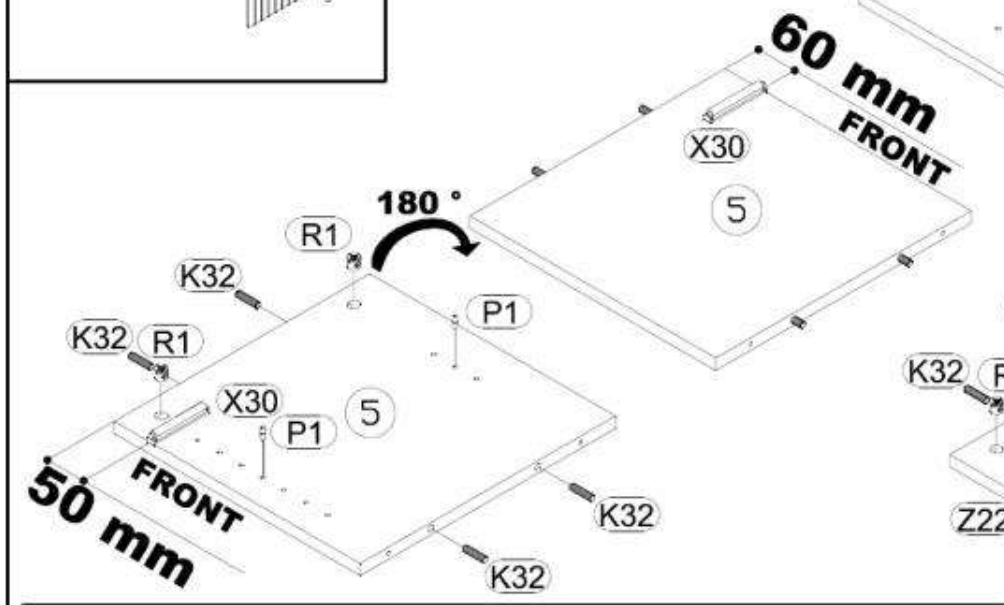
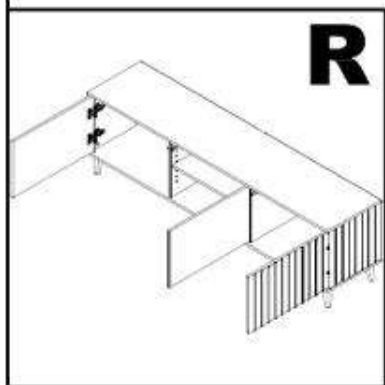

3

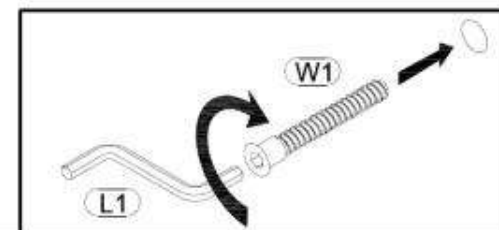
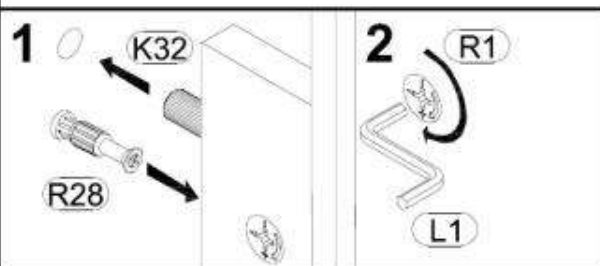
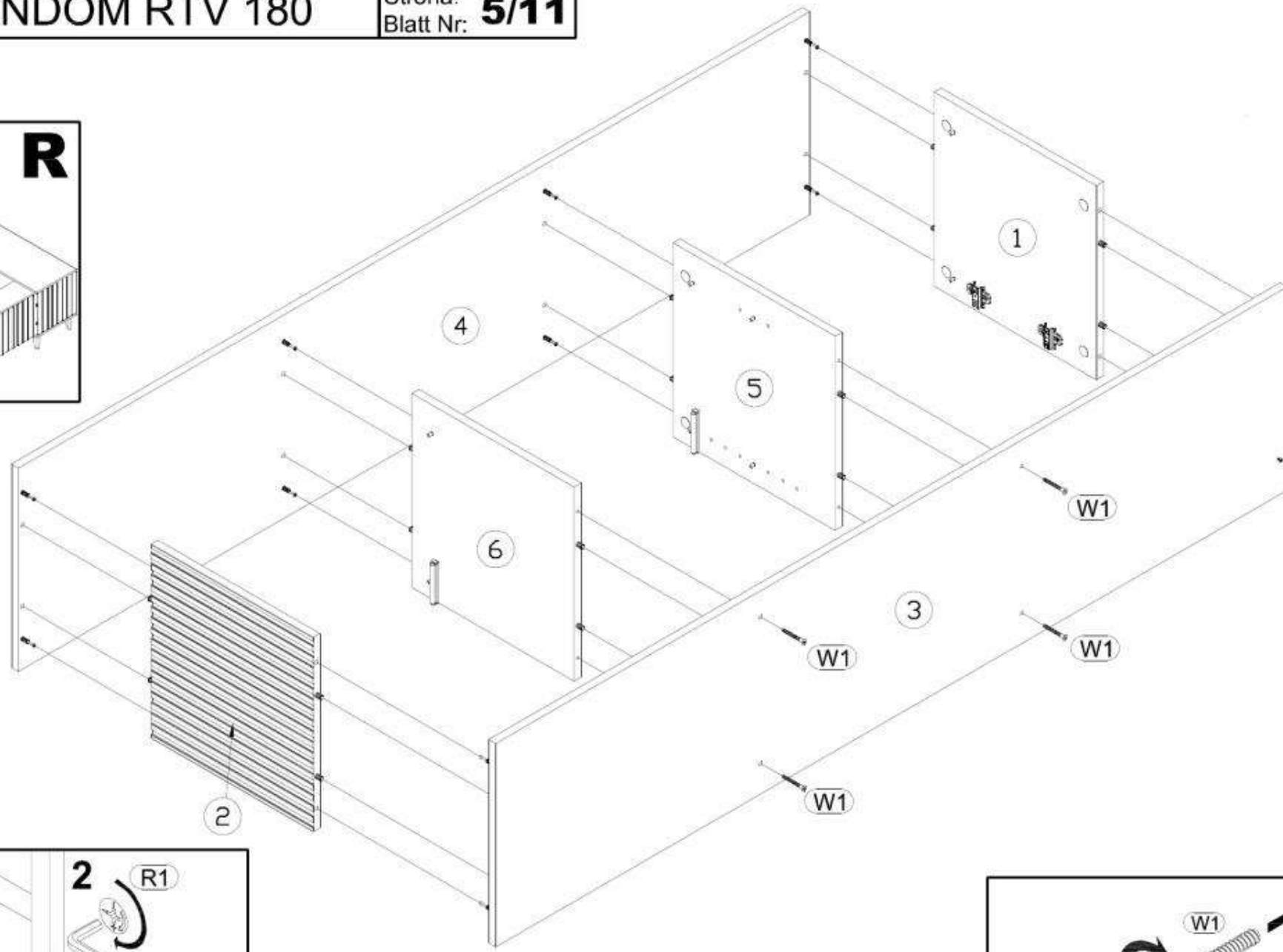
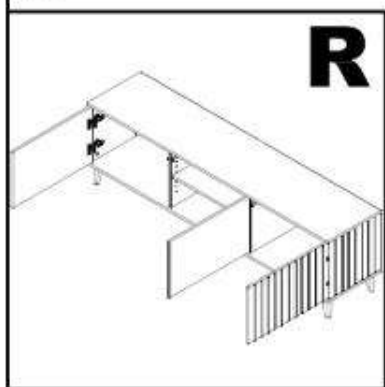

4

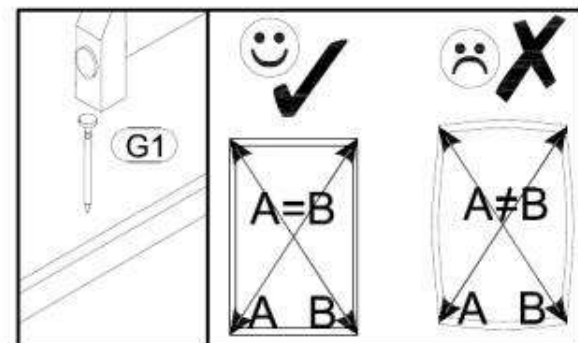
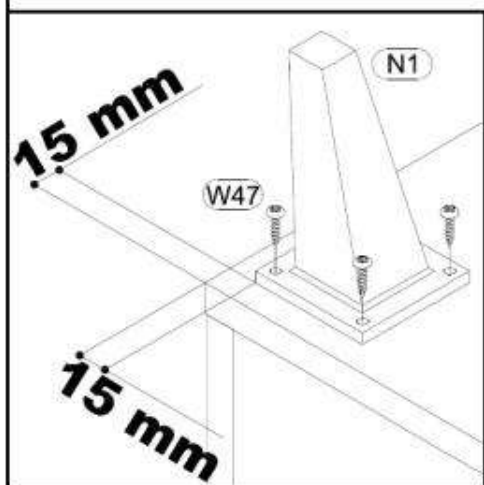
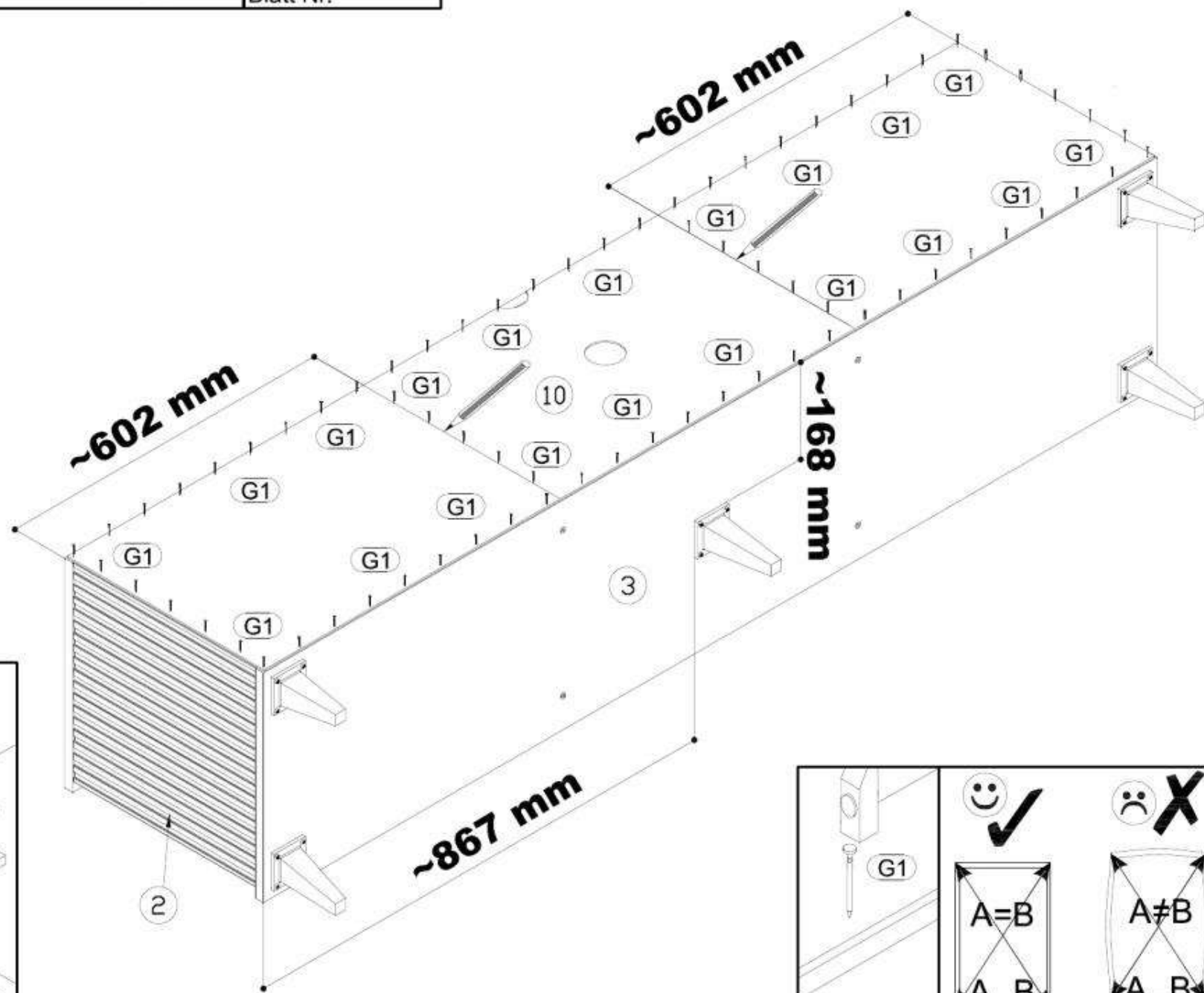
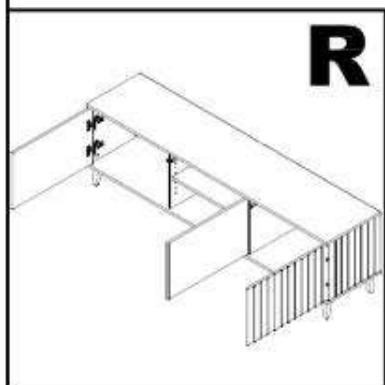

5

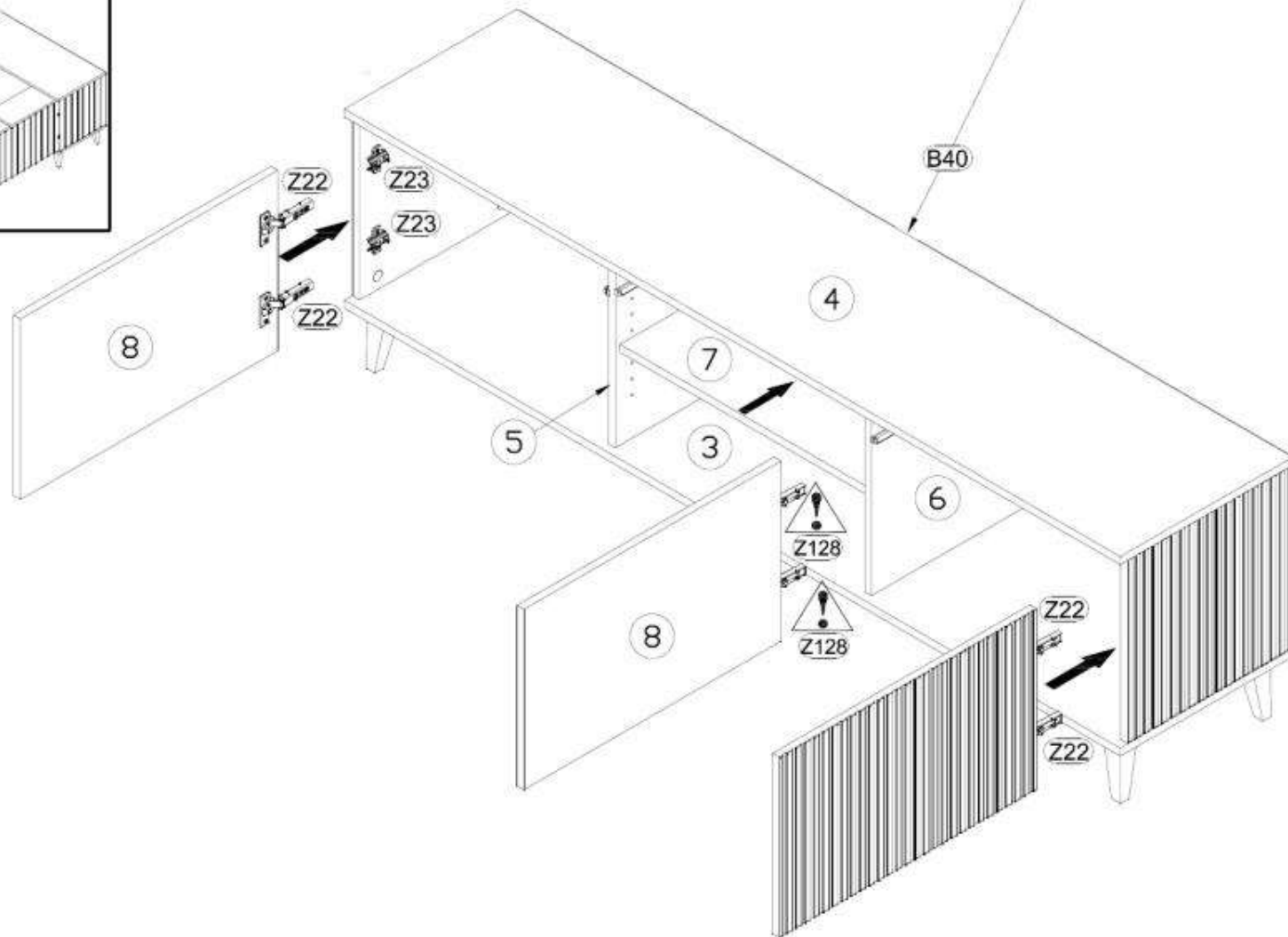
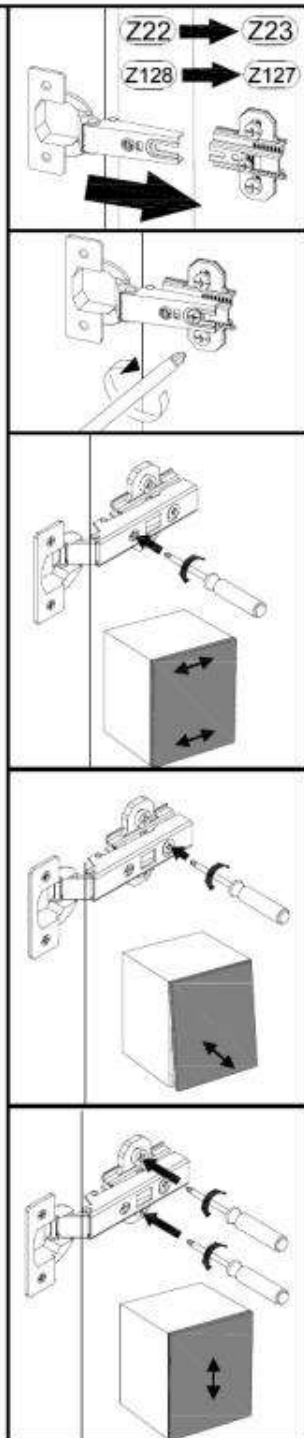
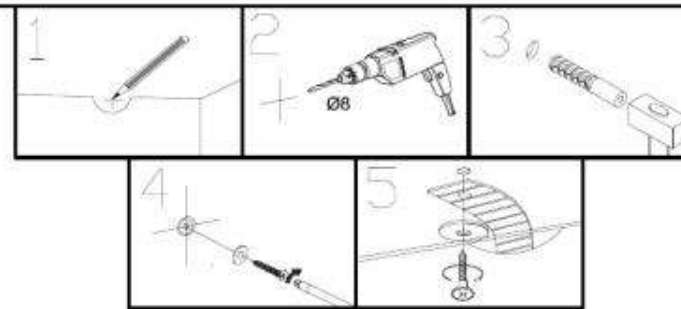
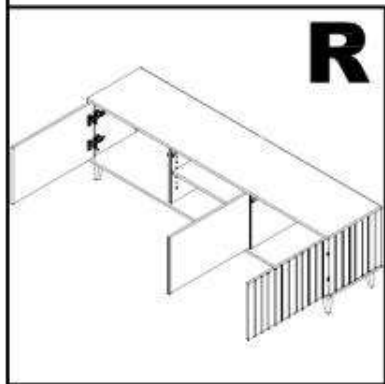

6

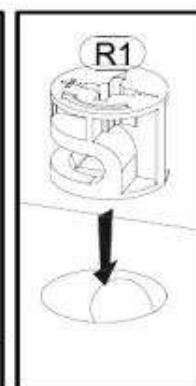
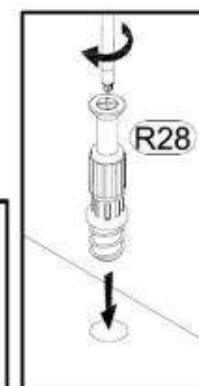
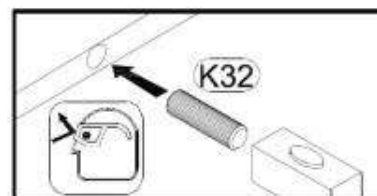
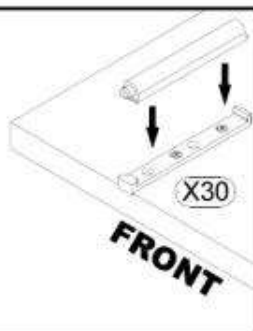
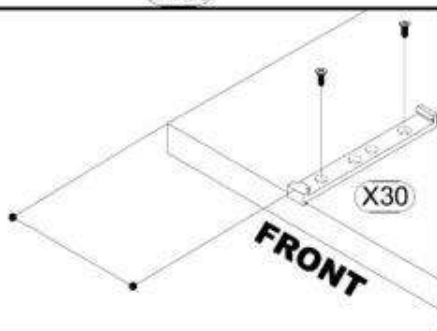
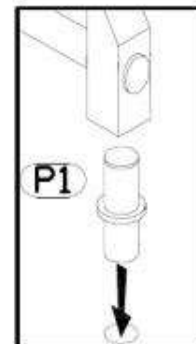
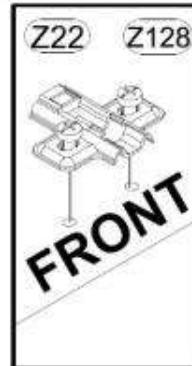
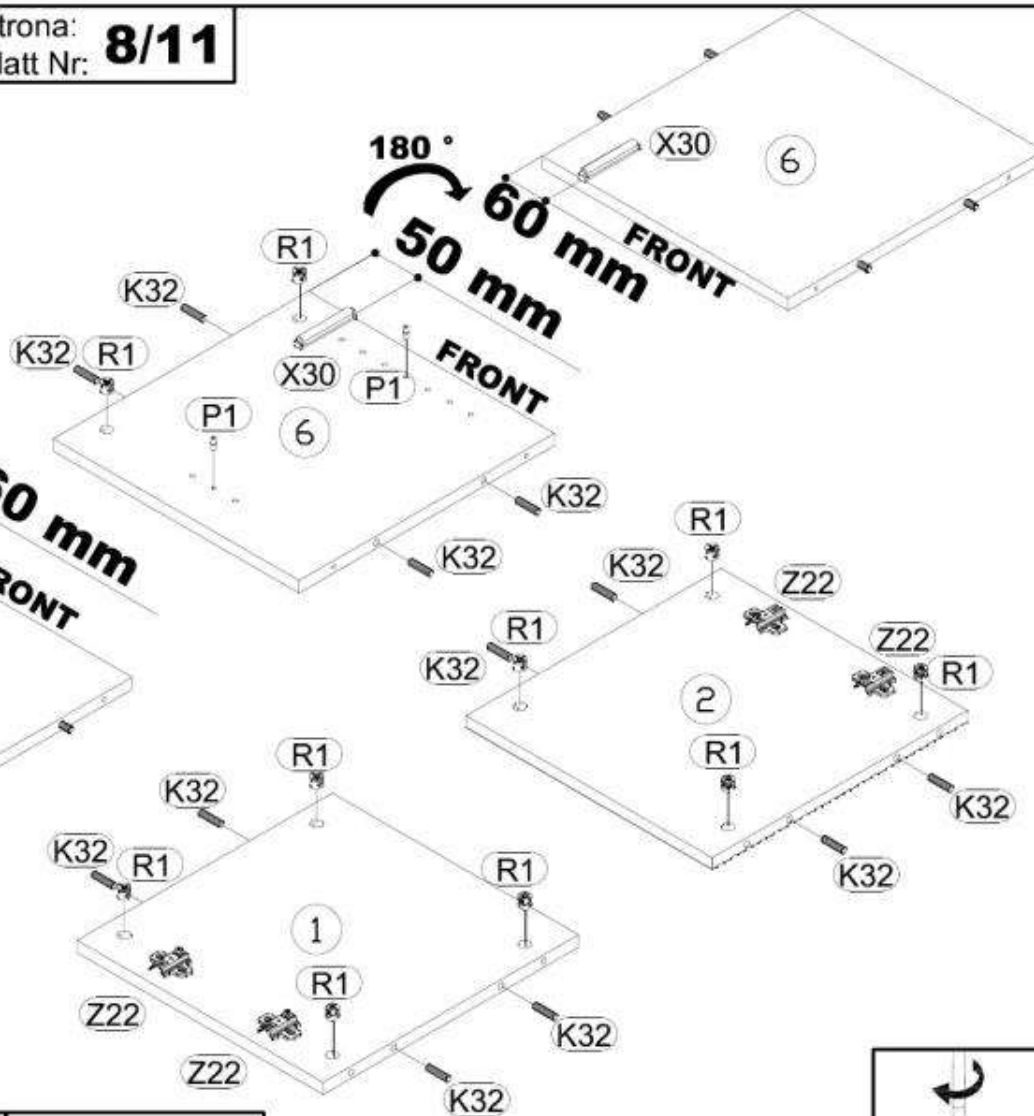
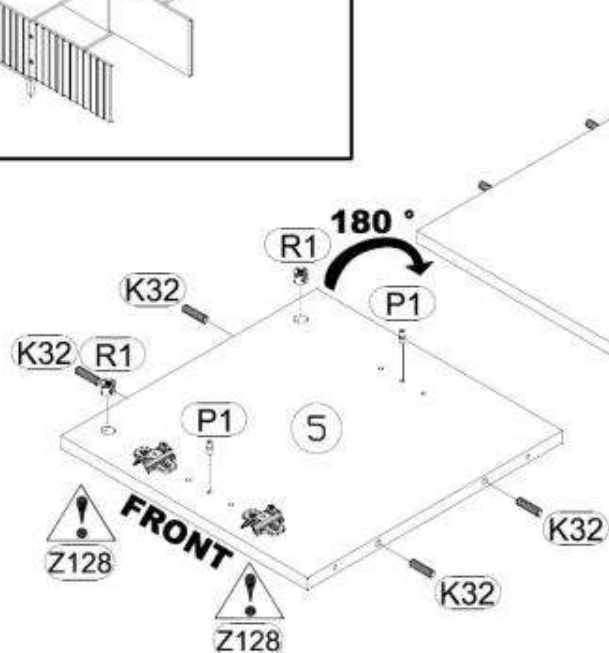
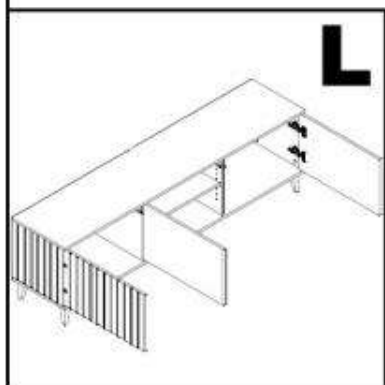

7

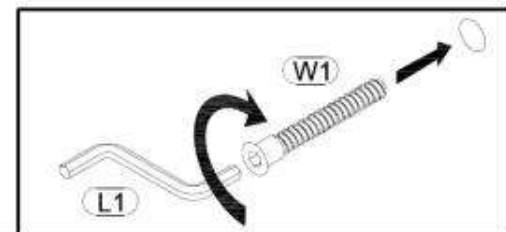
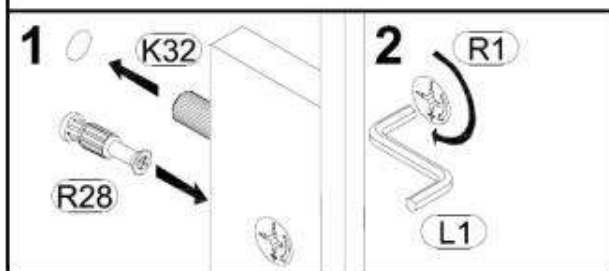
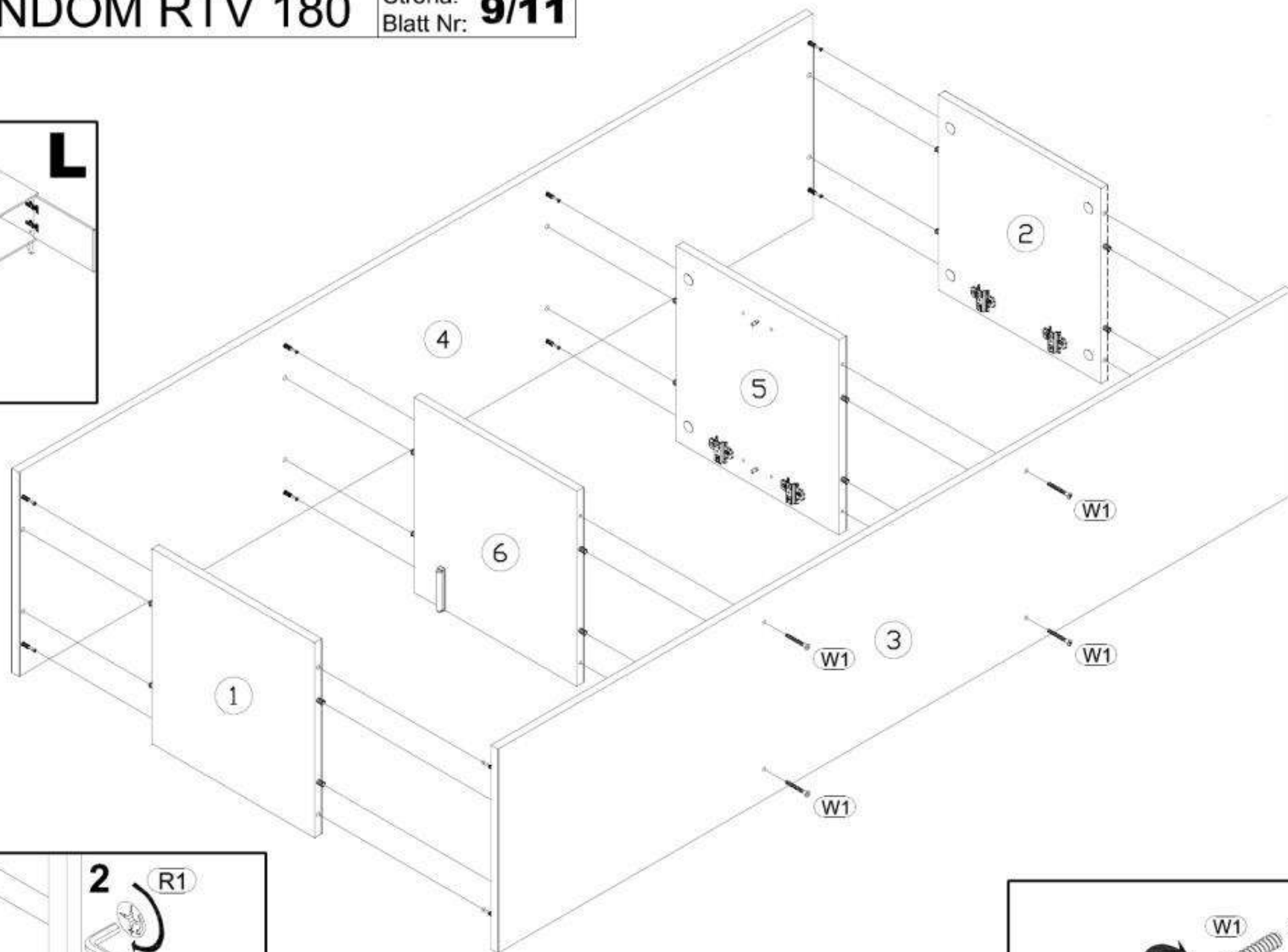
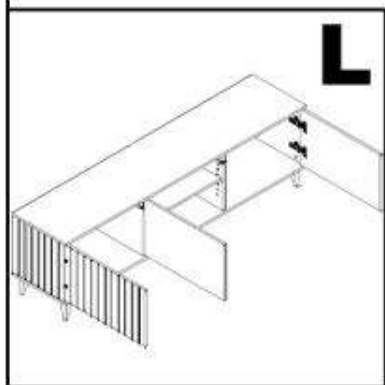

8

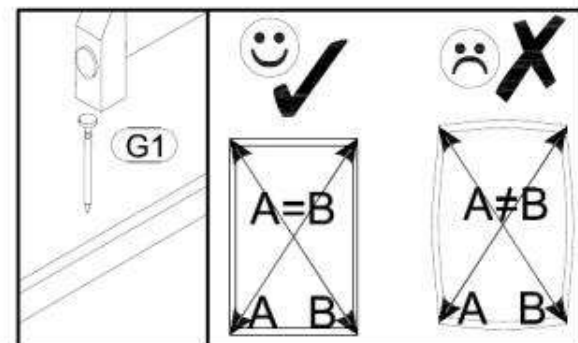
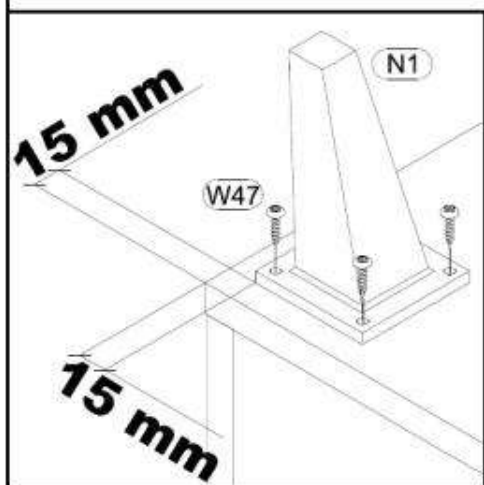
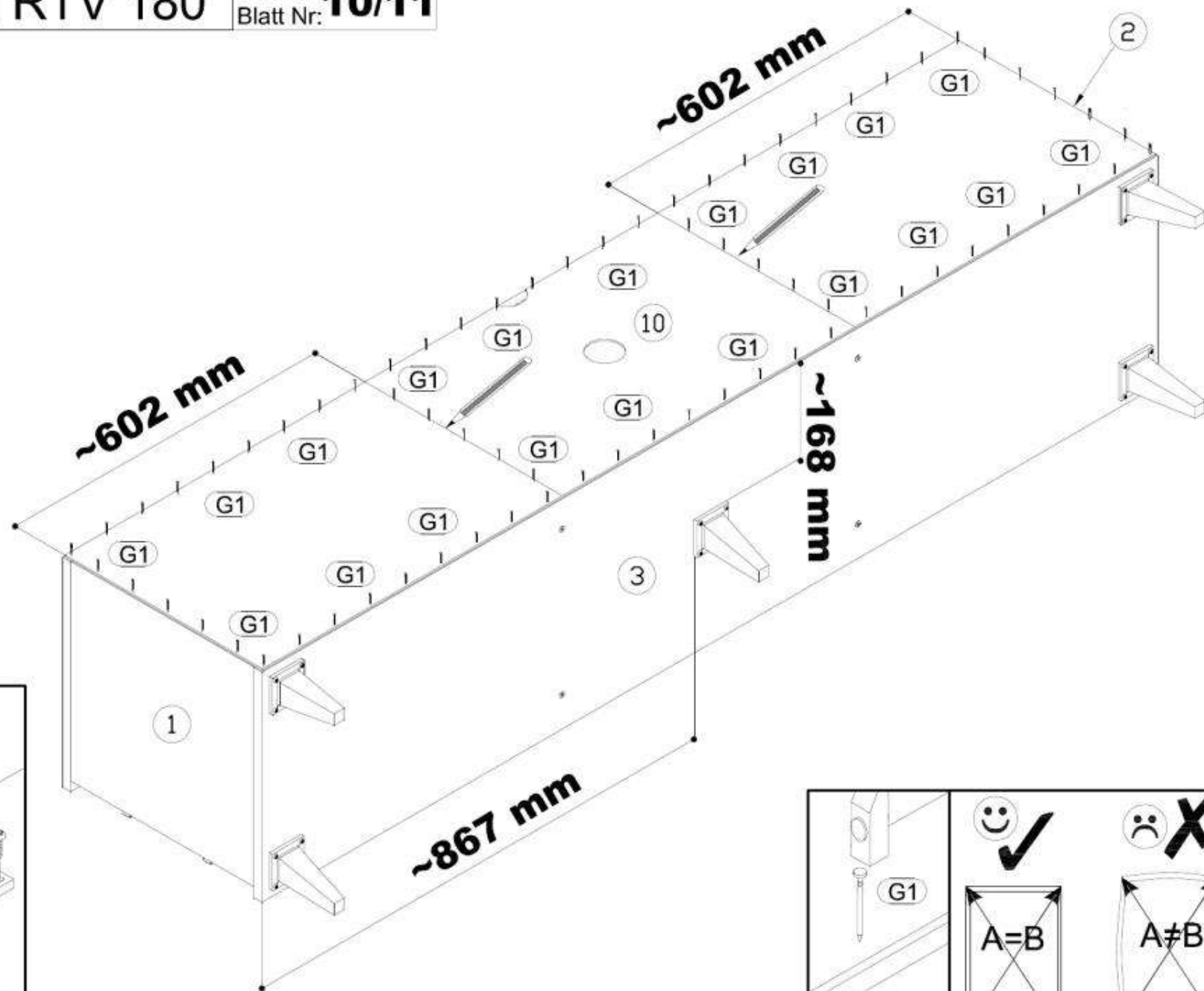
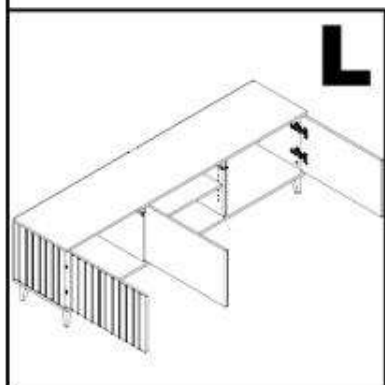

9

