

DALTON 2 NEW VE 02

UNIVERZALNY

Art.-Nr.	243987	1675	1/9
	243925	750	
	243866	1380	
		mm	Z0





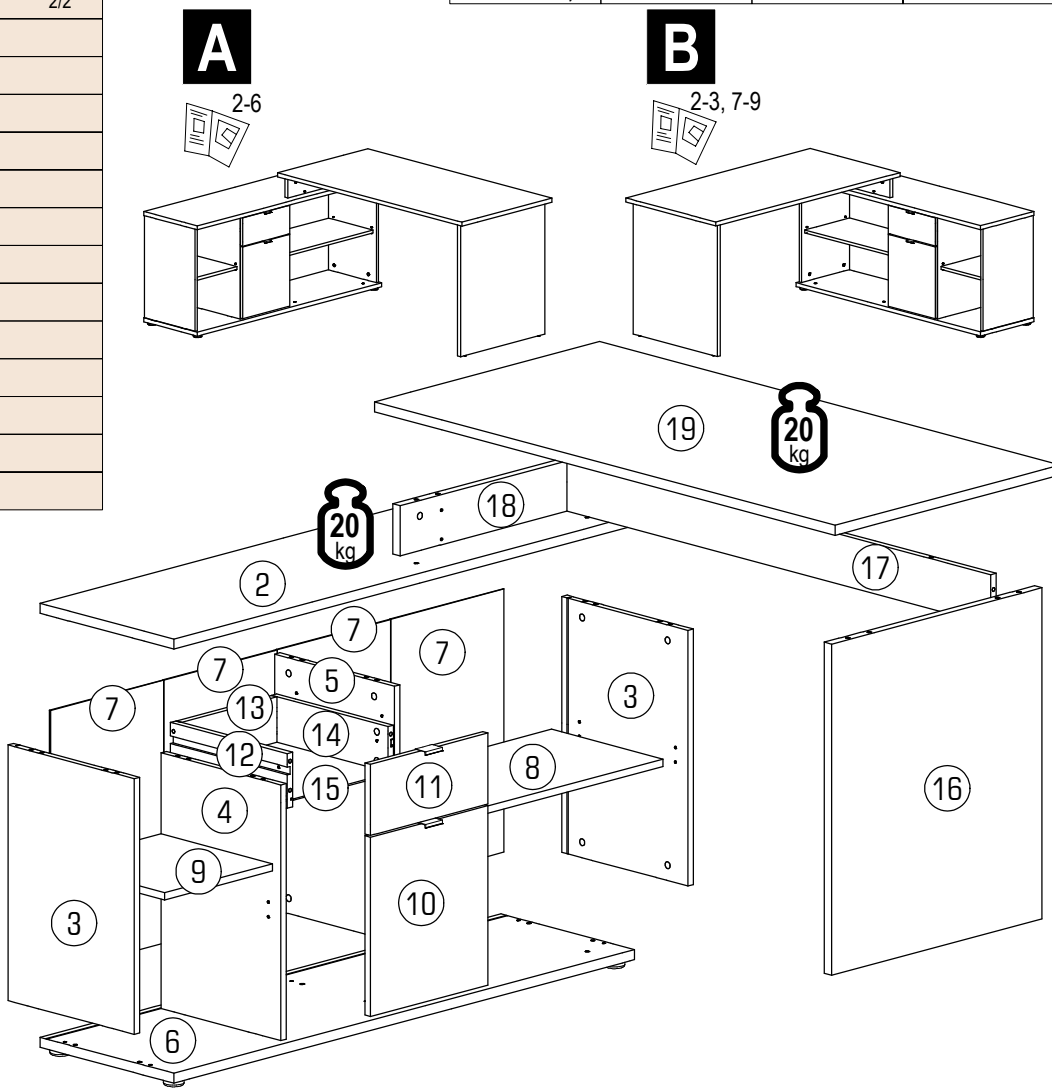



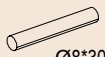

15967	②	1380*400*22	1x	2/2
15968	③	562*378*16	2x	2/2
15969	④	562*359*16	1x	2/2
15970	⑤	562*359*16	1x	2/2
15971	⑥	1380*400*22	1x	2/2
15972	⑦	578*339*2,5	1x	1/2
12375	⑧	663*334*16	1x	1/2
12376	⑨	323*334*16	1x	1/2
15973	⑩	352*394*16	1x	1/2
15974	⑪	352*156*16	1x	1/2
07870	⑫	350*120*16	1x	1/2
15975	⑬	286*100*16	1x	1/2
07871	⑭	350*120*16	1x	1/2
15976	⑮	356*296*2,5	1x	1/2
15977	⑯	728*630*22	1x	1/2
15978	⑰	1270*110*16	1x	1/2
15979	⑱	110*630*22	1x	1/2
15980	⑲	1380*674*22	1x	1/2

✓		180 min	
PZ 2,1	4		3m

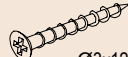

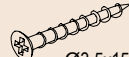

	50553.00	22244.01	30091.00	27000.00		70013.01	70021.01	22300.00	22705.00
A	15x	B	2x	C	2x	D	20x	E	27x
K	2x	L	8x	M	8x	N	4x	P	1x
Q	4x	R	12x	S	8x	T	2x	U	2x
V	2x	W	2x	X	5x	Y	5x		1x



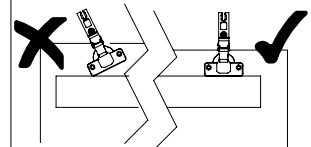
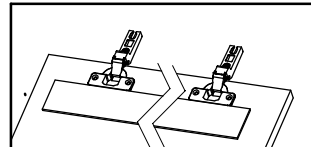
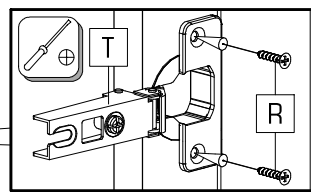
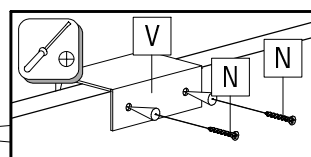
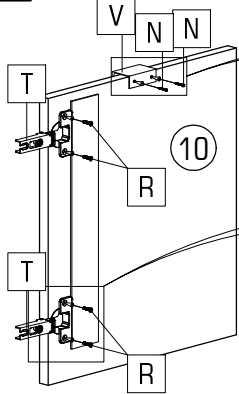
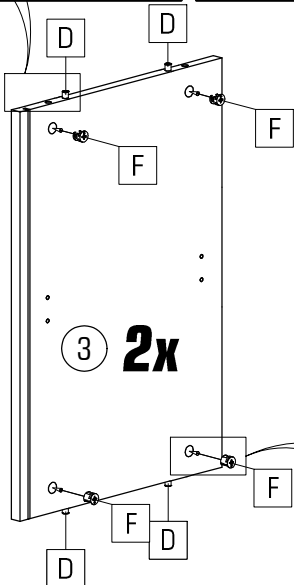
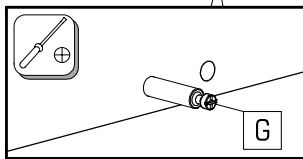
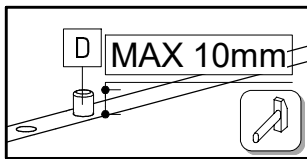
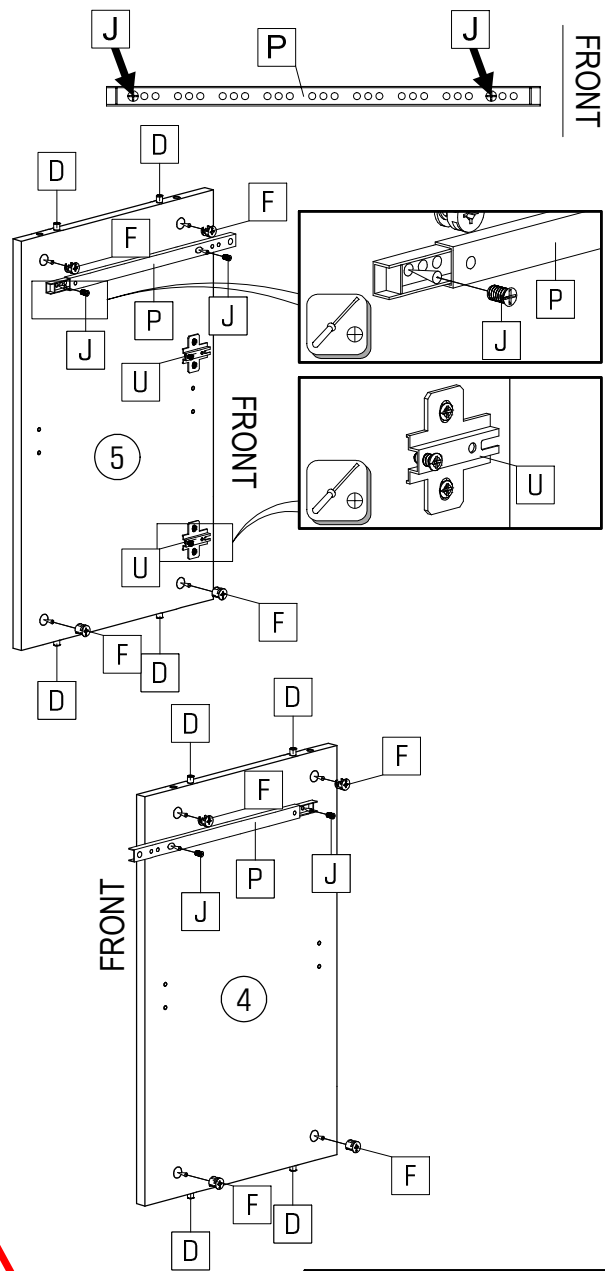
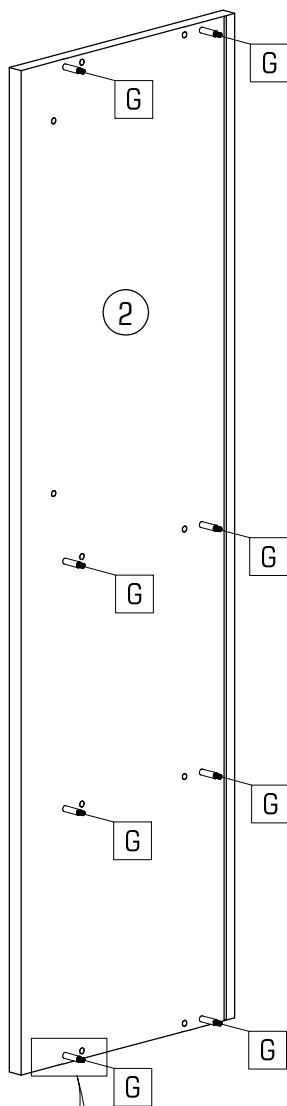
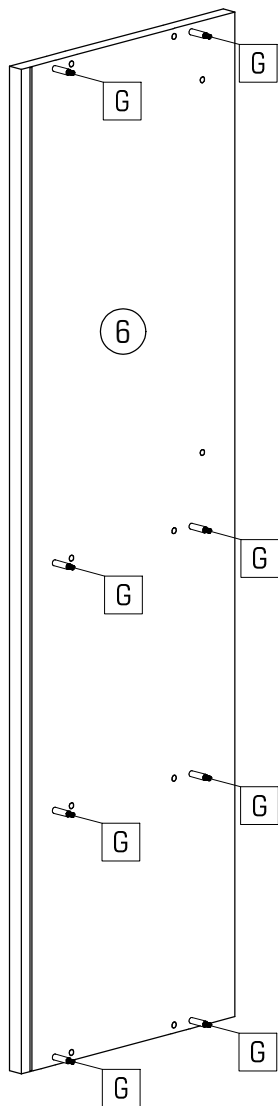

✗	✓	✗	✓	✗	✓	✗	✗	✗	✗

									
D 16x	F 16x	G 16x	J 4x	N 4x	P 1x	R 4x	T 2x	U 2x	V 1x

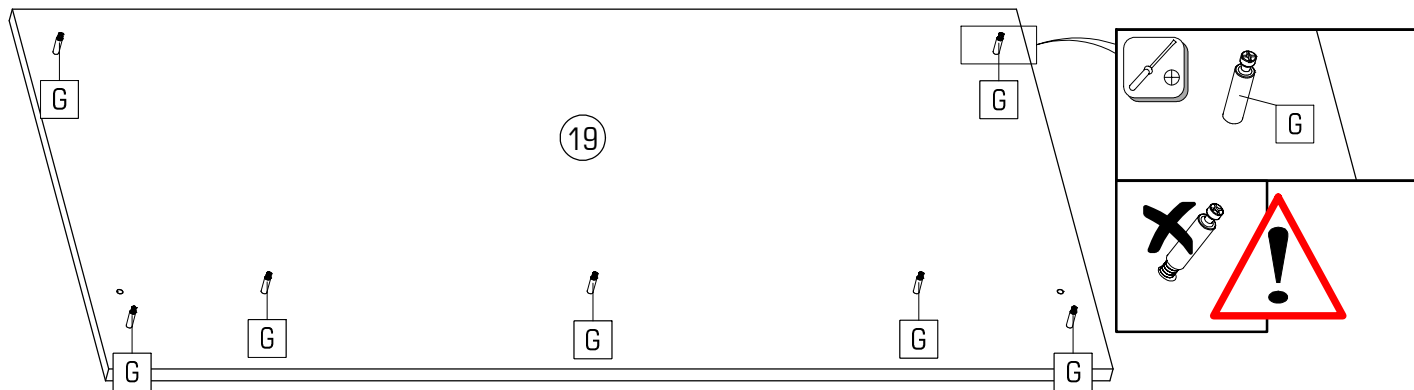
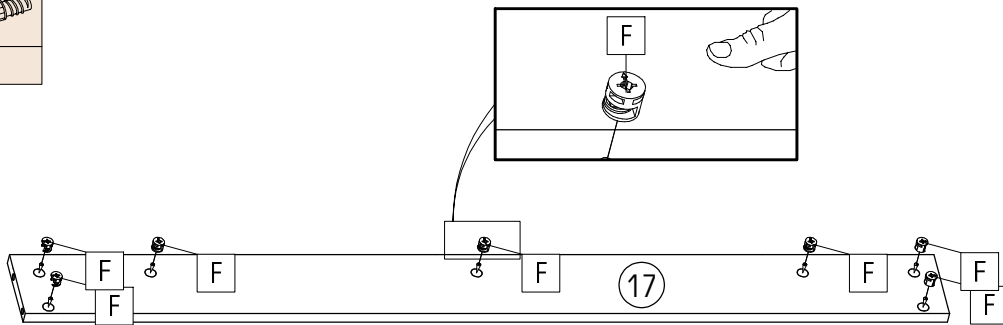

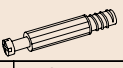
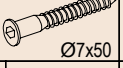
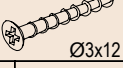

	
F 7x	G 7x



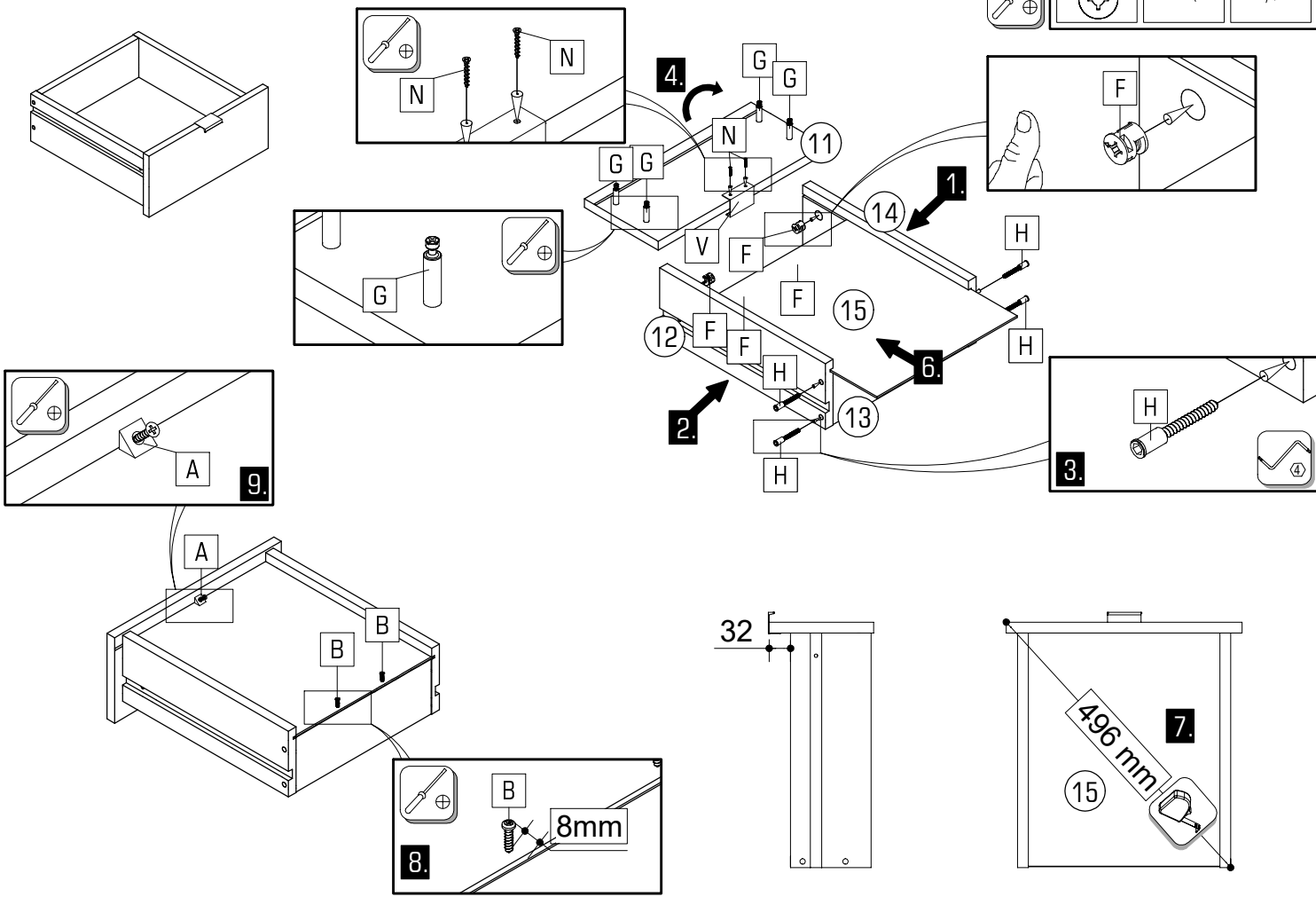
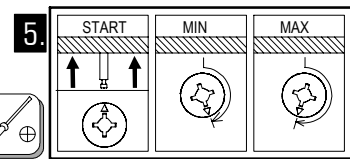

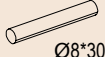

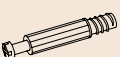
						
A 1x	B 2x	F 4x	G 4x	H 4x	N 2x	V 1x

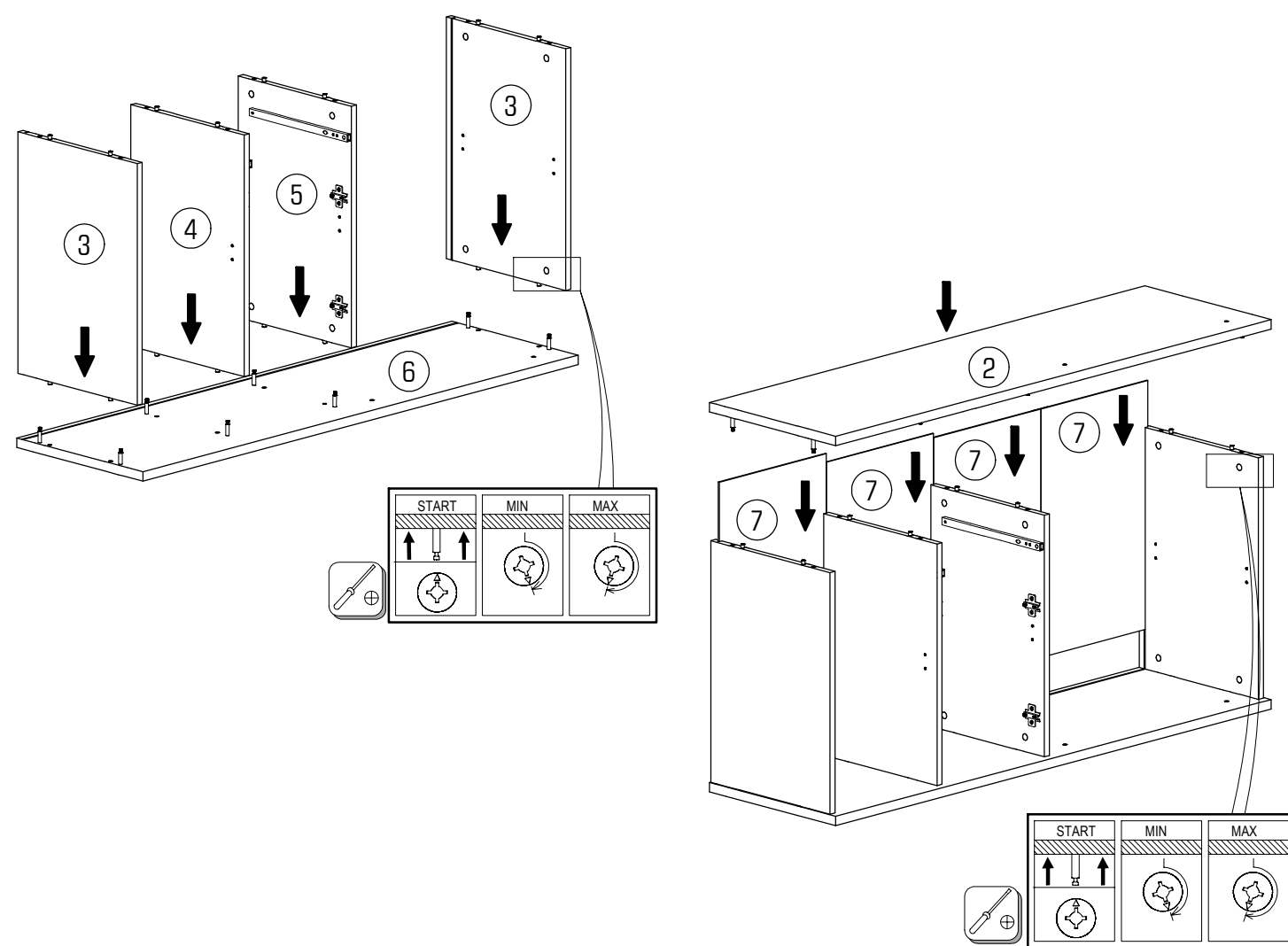
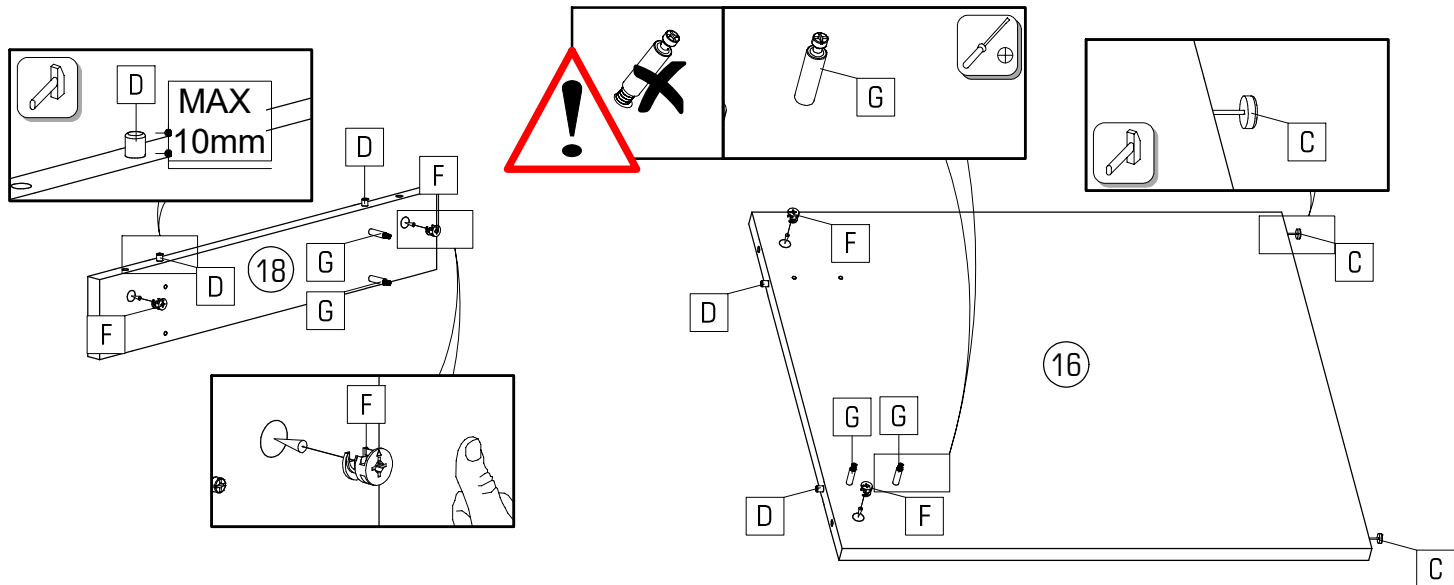

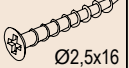

			
C	2x	D	4x
		F	4x
		G	4x



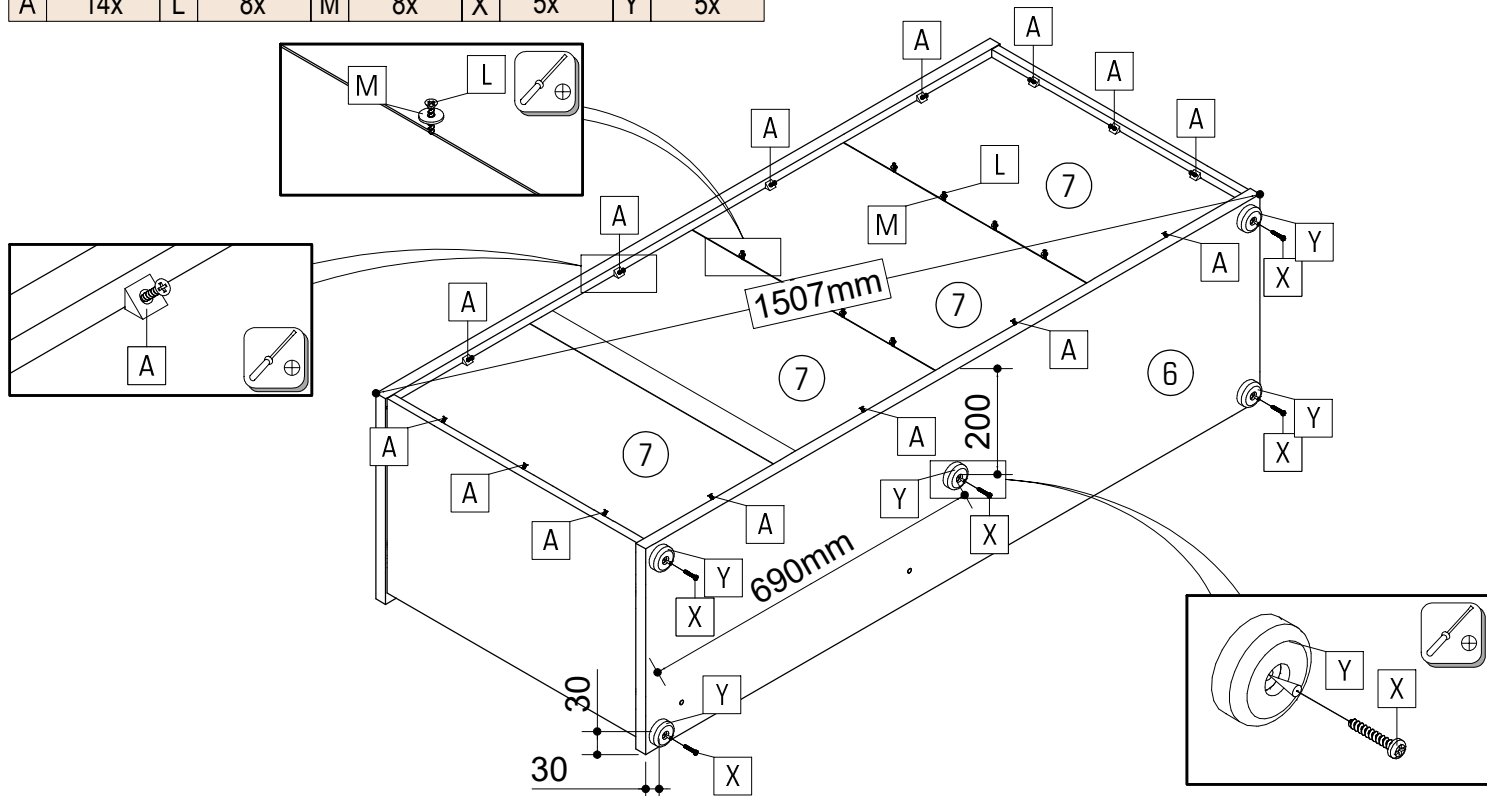

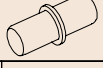

				
A 14x	L 8x Ø2,5x16	M 8x 3,0	X 5x Ø4x25	Y 5x Ø44x15

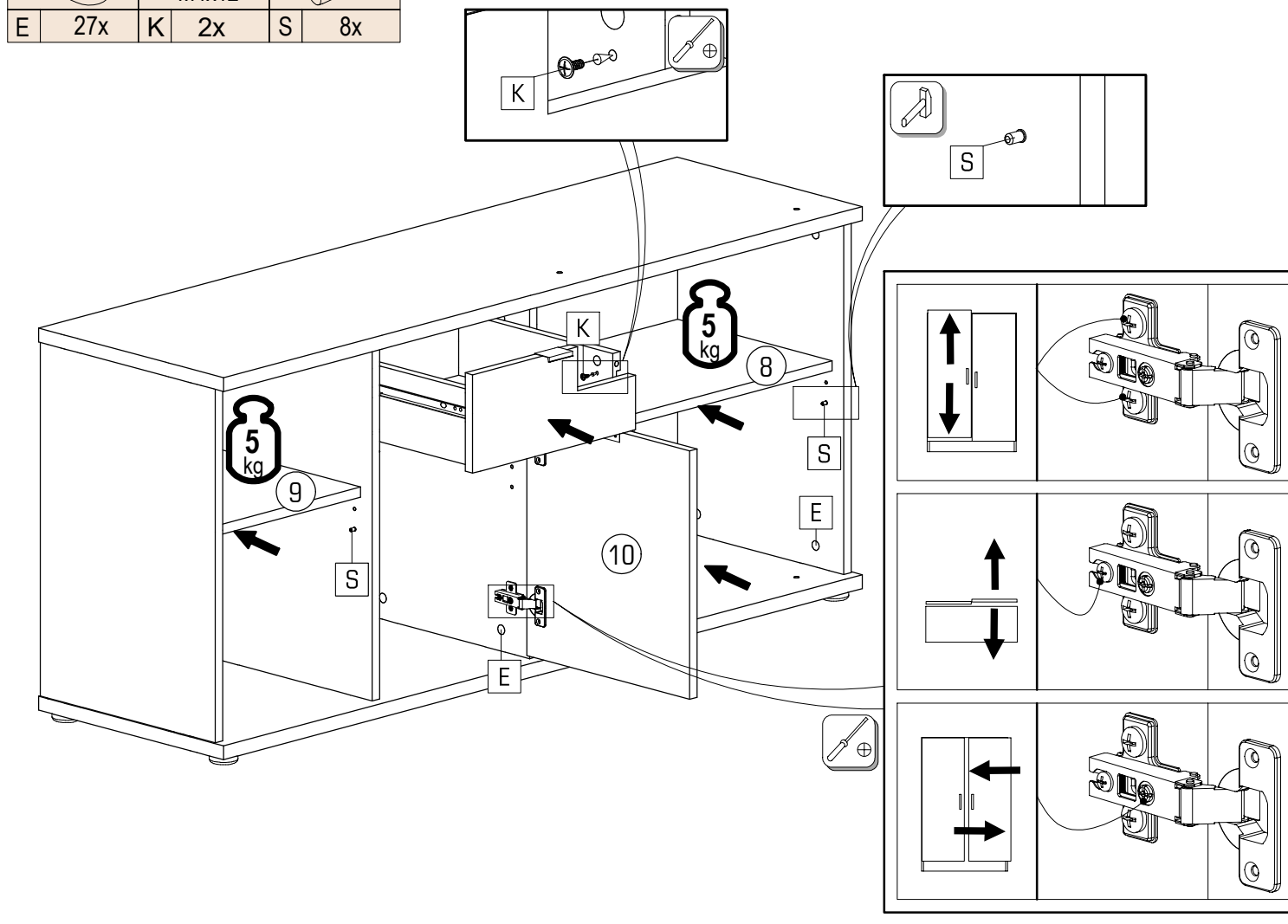

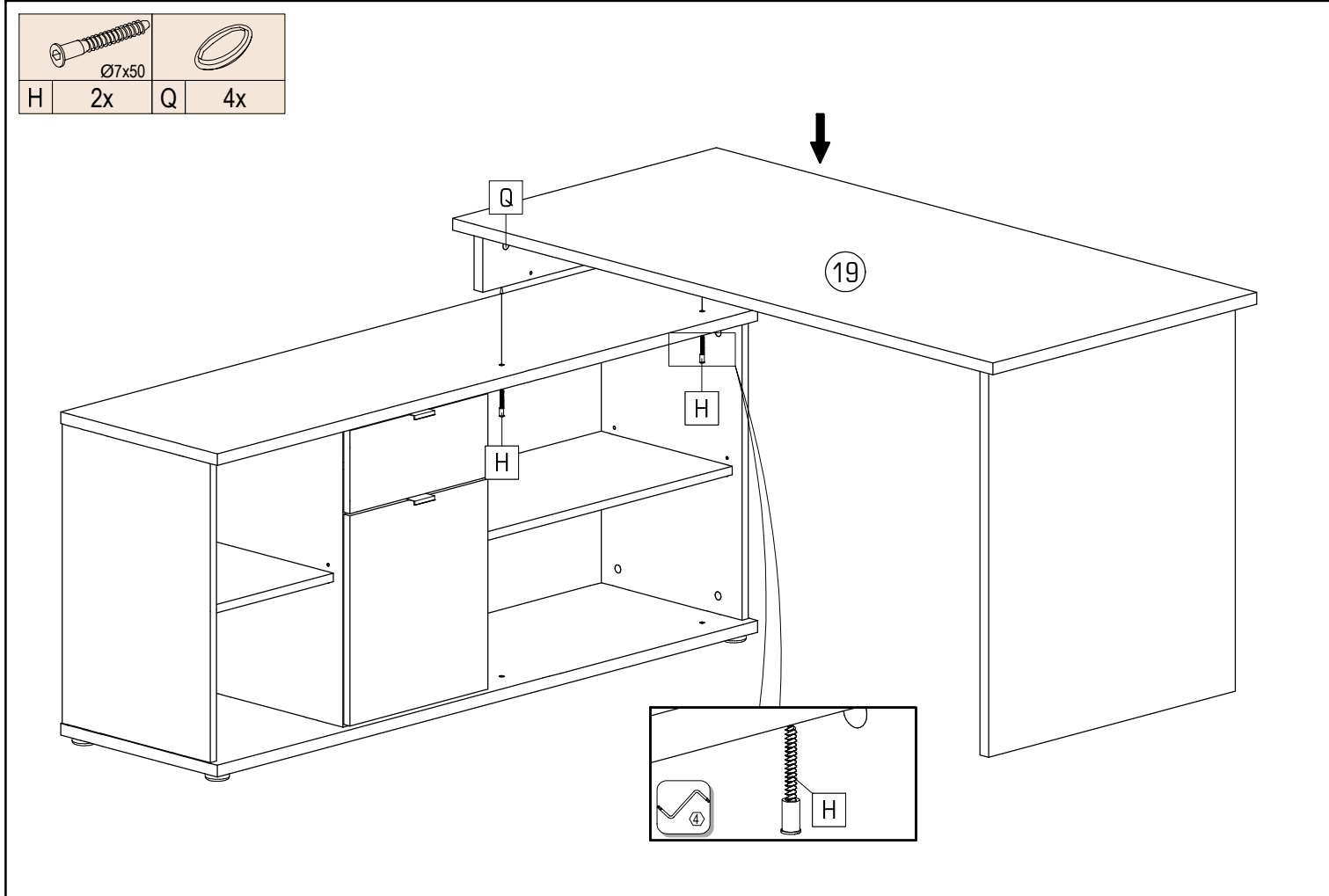
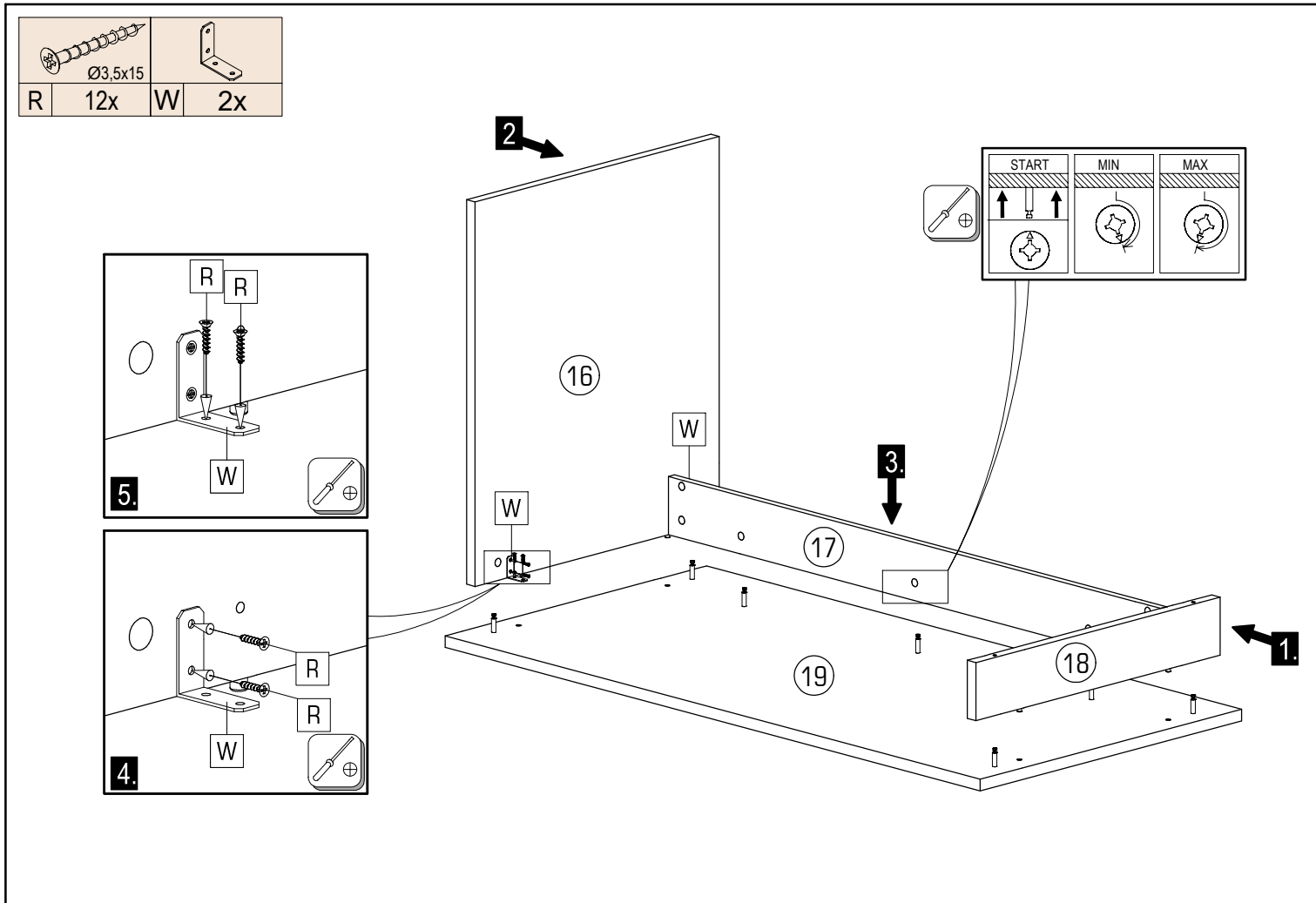



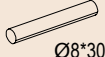

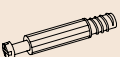
		
E 27x	K 2x M4x12	S 8x

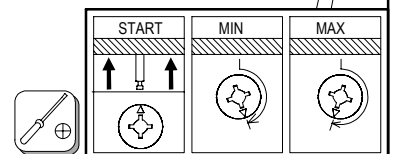
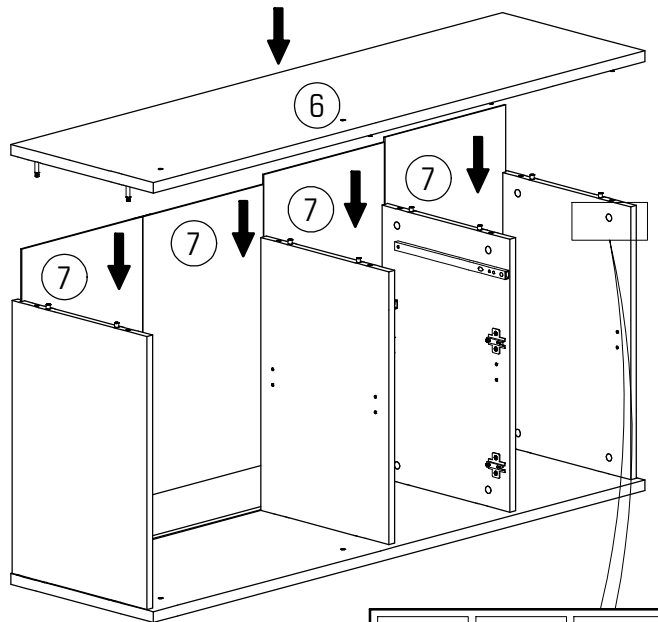
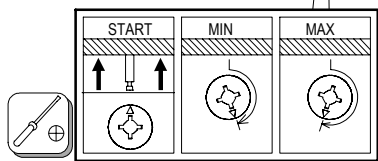
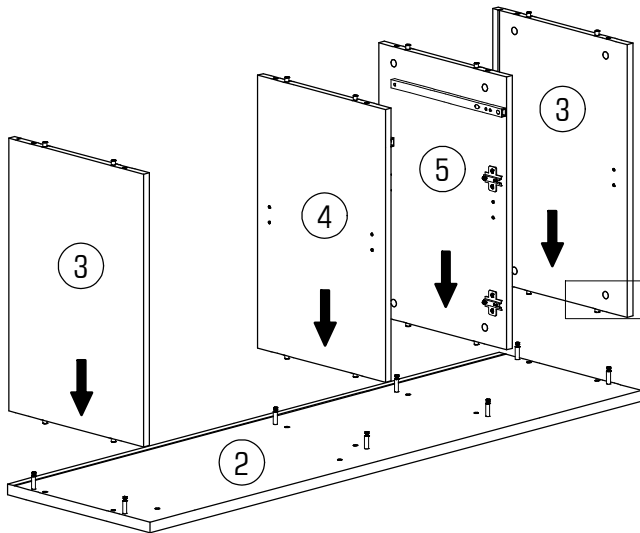
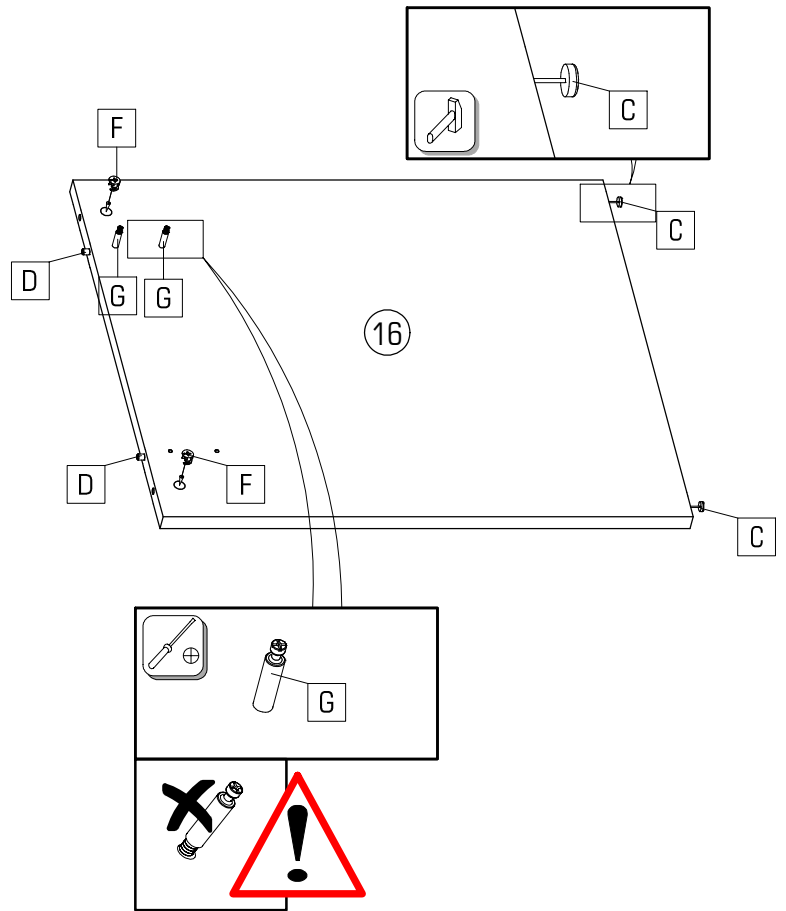
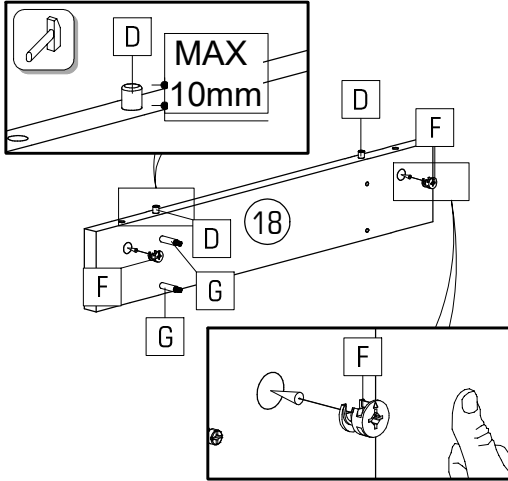



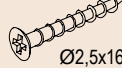

			
C	2x	D	4x
		F	4x
		G	4x



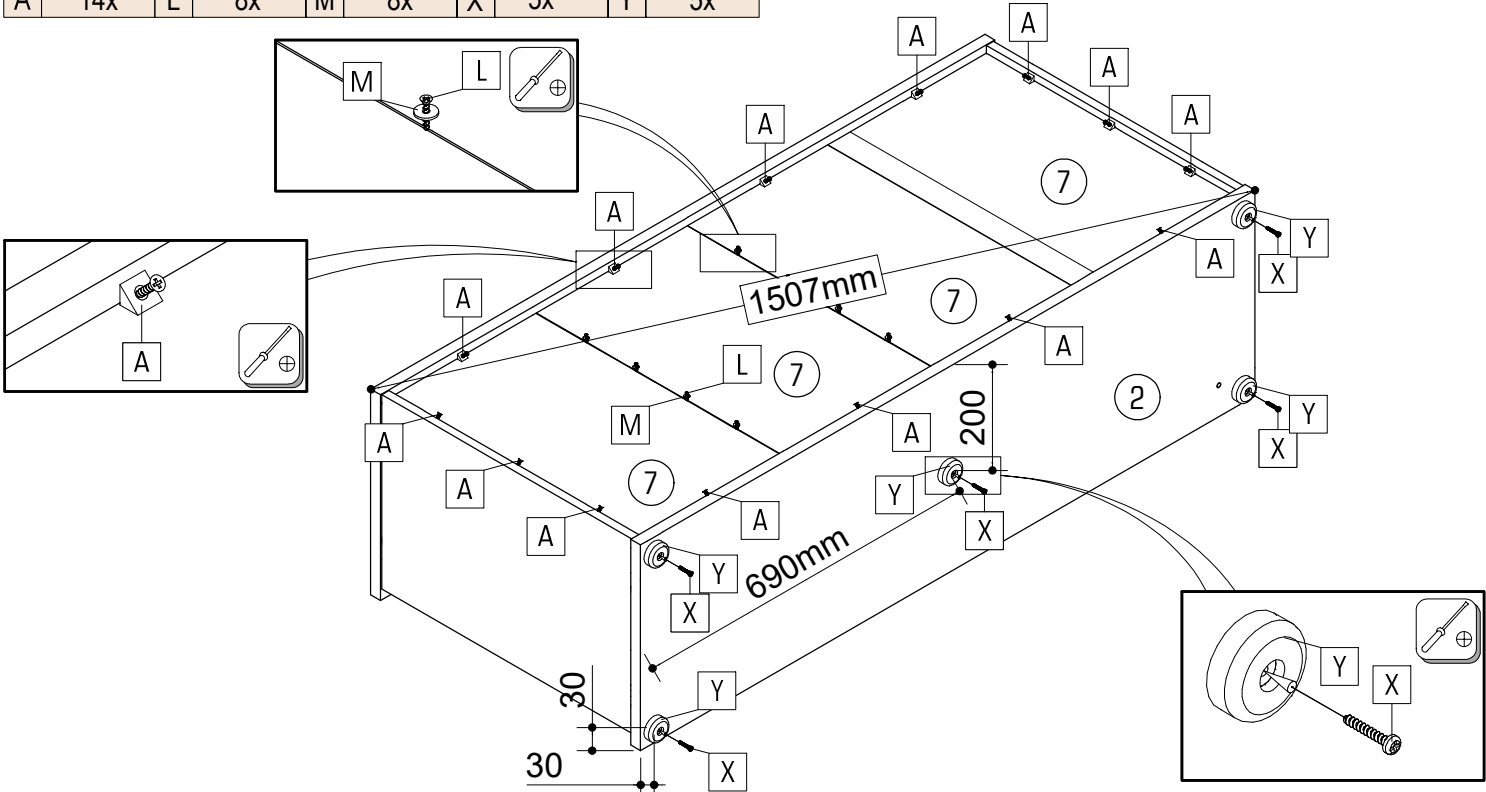

				
A 14x	L 8x	M 8x	X 5x	Y 5x

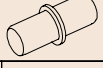

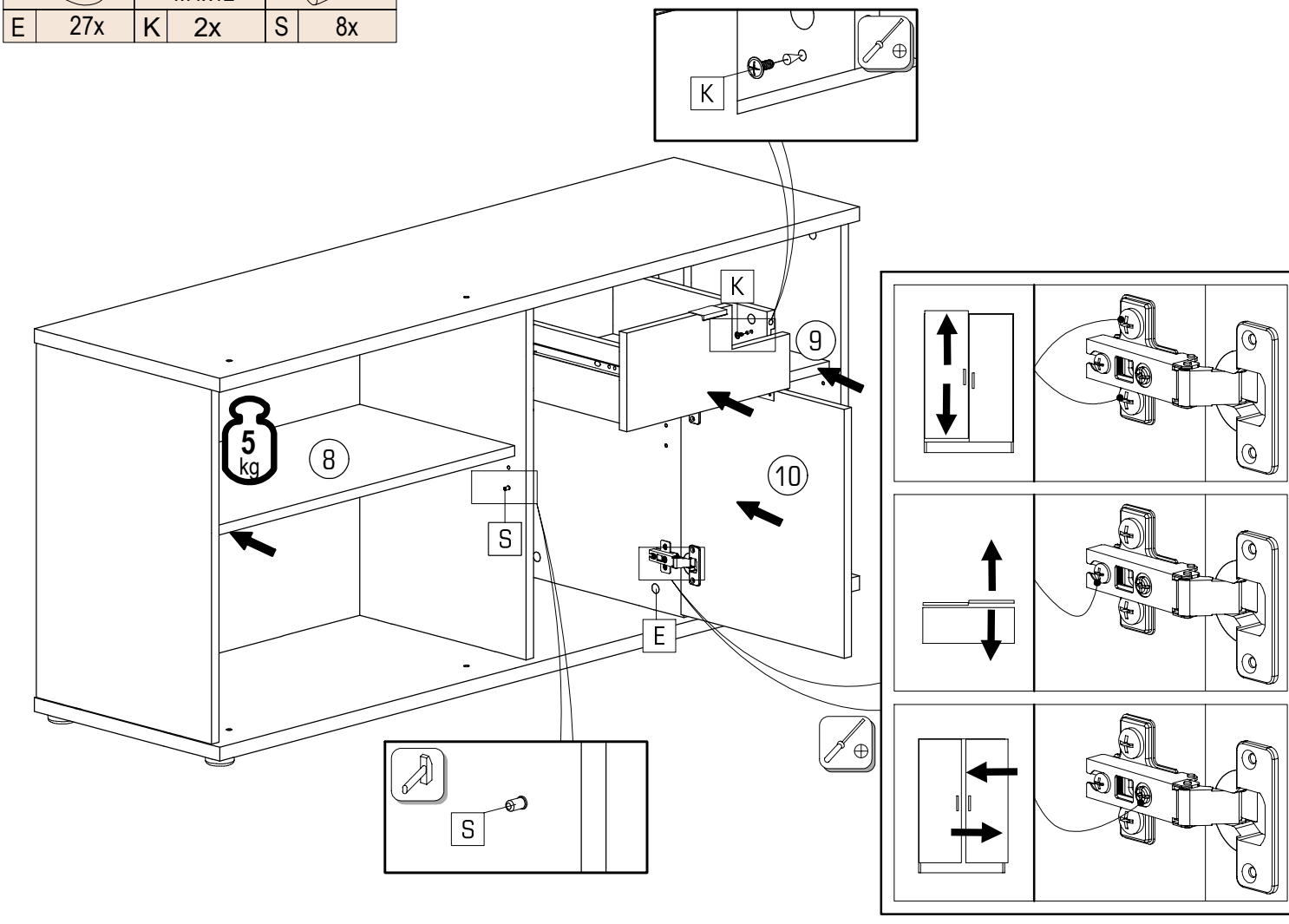

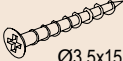
		
E 27x	K 2x	S 8x

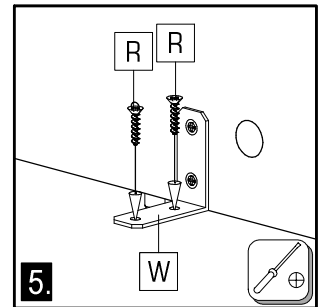
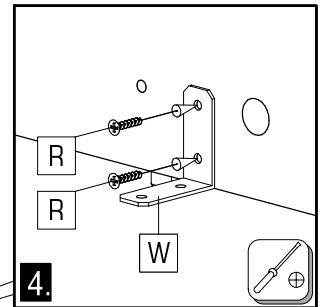
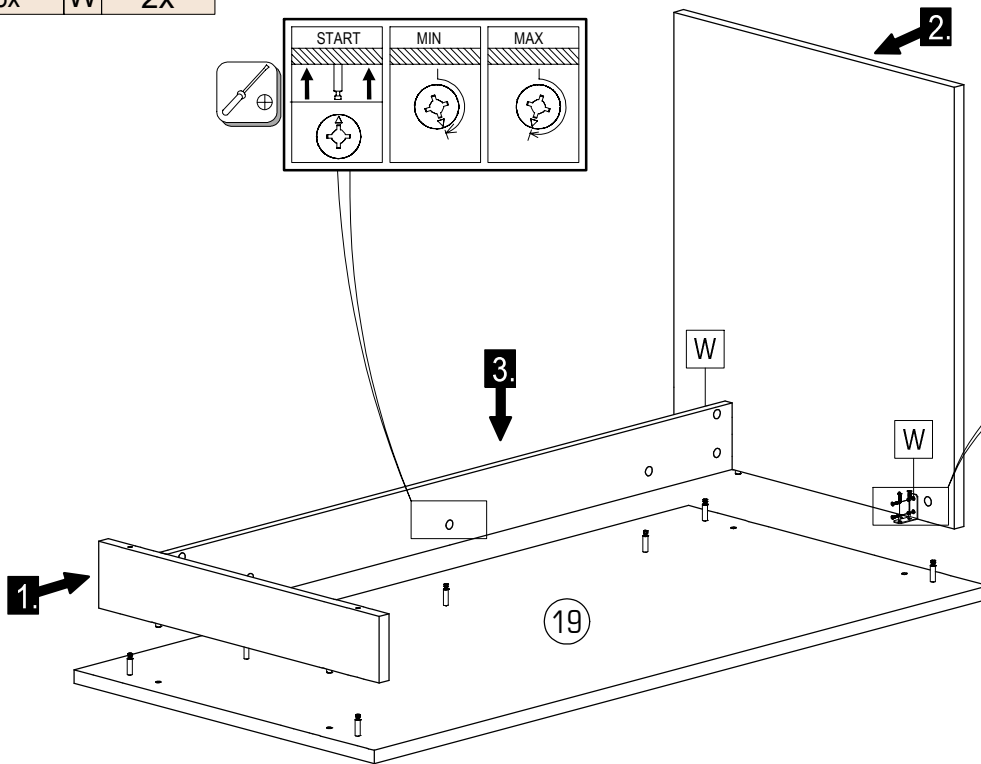
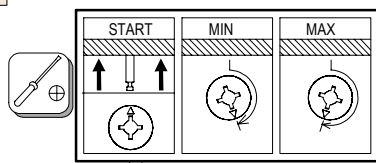

	$\varnothing 3,5 \times 15$	
R	8x	W 2x



	$\varnothing 7 \times 50$	
H	2x	Q 4x

