

SAFARI 2K1S

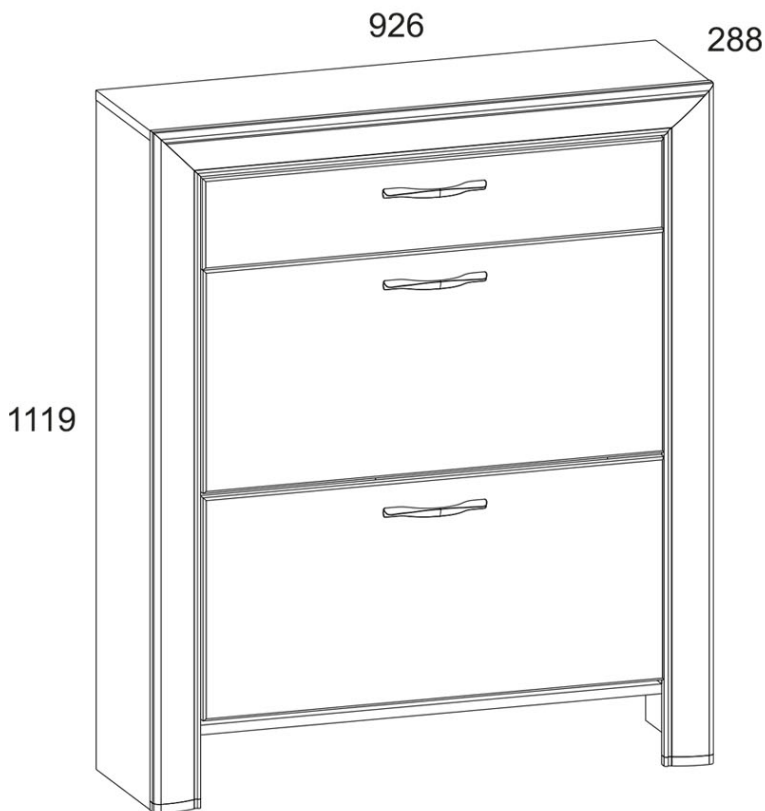

Kód	L, mm	B, mm	H, mm		Balík
1	925	260	16	1	1/2
2	892	260	16	1	1/2
4	1098	260	16	1	1/2
5	1098	260	16	1	1/2
6	966	260	16	1	1/2
7	966	260	16	1	1/2
8	762	366	16	2	2/2
9	754	90	10	2	2/2
10	754	140	10	4	2/2
11	1100	80	25	1	1/2
12	1100	80	25	1	1/2
13	926	80	25	1	1/2
15	762	150	16	1	2/2
16	250	100	16	1	2/2
17	250	100	16	1	2/2
18	708	100	16	1	2/2
19	738	255	2,5	1	2/2
20	995	920	2,5	1	2/2

Pri používaní nábytku je zakázané:

- Umiestňovať nábytok v blízkosti vykurovacích zariadení a vedľa vlhkých stien, ako aj v miestnostiach s relatívnou vlhkosťou vyššou ako 70 %
- Teplota vykurovania nábytkových prvkov nesmie prekročiť +40 °C
- Počas montáže a používania nábytku nestojte nohami na vodorovných paneloch a oknách
- Na čistenie nábytku nepoužívajte chemické čistiace prostriedky
- Nesmie byť vystavený pôsobeniu vody

Vôňa.

Nový nábytok môže mať vôňu materiálov, z ktorých je vyrobený. Vôňa môže pretrvávať až tri týždne po inštalácii.

Na zníženie intenzity vône sa odporúča:

- V prípade čalúneného nábytku – výrobok povysávať a miestnosť vyvetrať.

Opakujte 3 – 4-krát denne

- V prípade skriň – utrite handričkou navlhčenou jemným čistiacim prostriedkom, následne utrite čistou, suchou handričkou a vyvetrajte miestnosť, pričom najprv otvorte všetky dverka a zásuvky výrobku

Opakujte 3 – 4-krát denne. Dôležité! Návod si uschovajte pre prípad opätovnej montáže nábytku alebo reklamácie.

Pri podávaní reklamácie použite označenie v návode.

VAROVANIE! Pád nábytku môže spôsobiť vážne alebo smrteľné zranenia v dôsledku pomliaždenín. **VŽDY** upevnite tento nábytok k stene pomocou obmedzovačov. Zabudovaný kolík sa

používa pri tehlových a betónových stenách. Na montáž na stenu

použijete upevňovacie prvky vhodné pre daný materiál steny. Ak si

nie ste istí, ktorý typ upevnenia je vhodný pre daný materiál steny,

obráťte sa na odborníka alebo špecializovanú predajňu. Za upevňovacie prvky je

v konečnom dôsledku zodpovedný inštalatér. Na ďalšie zníženie rizika vážnych





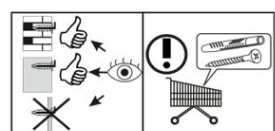
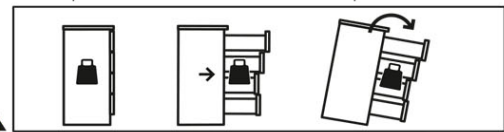

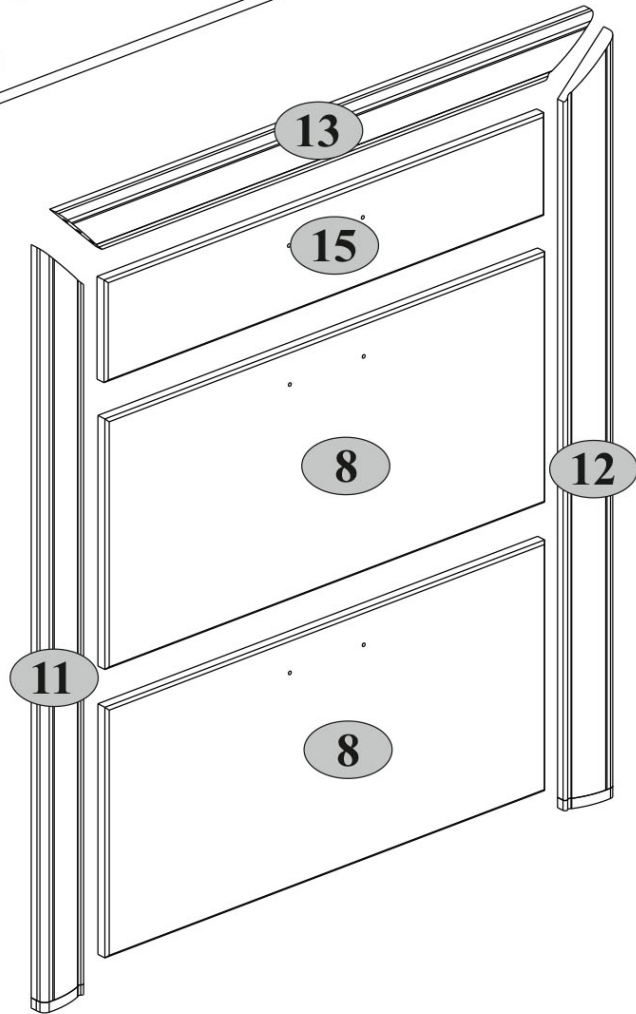
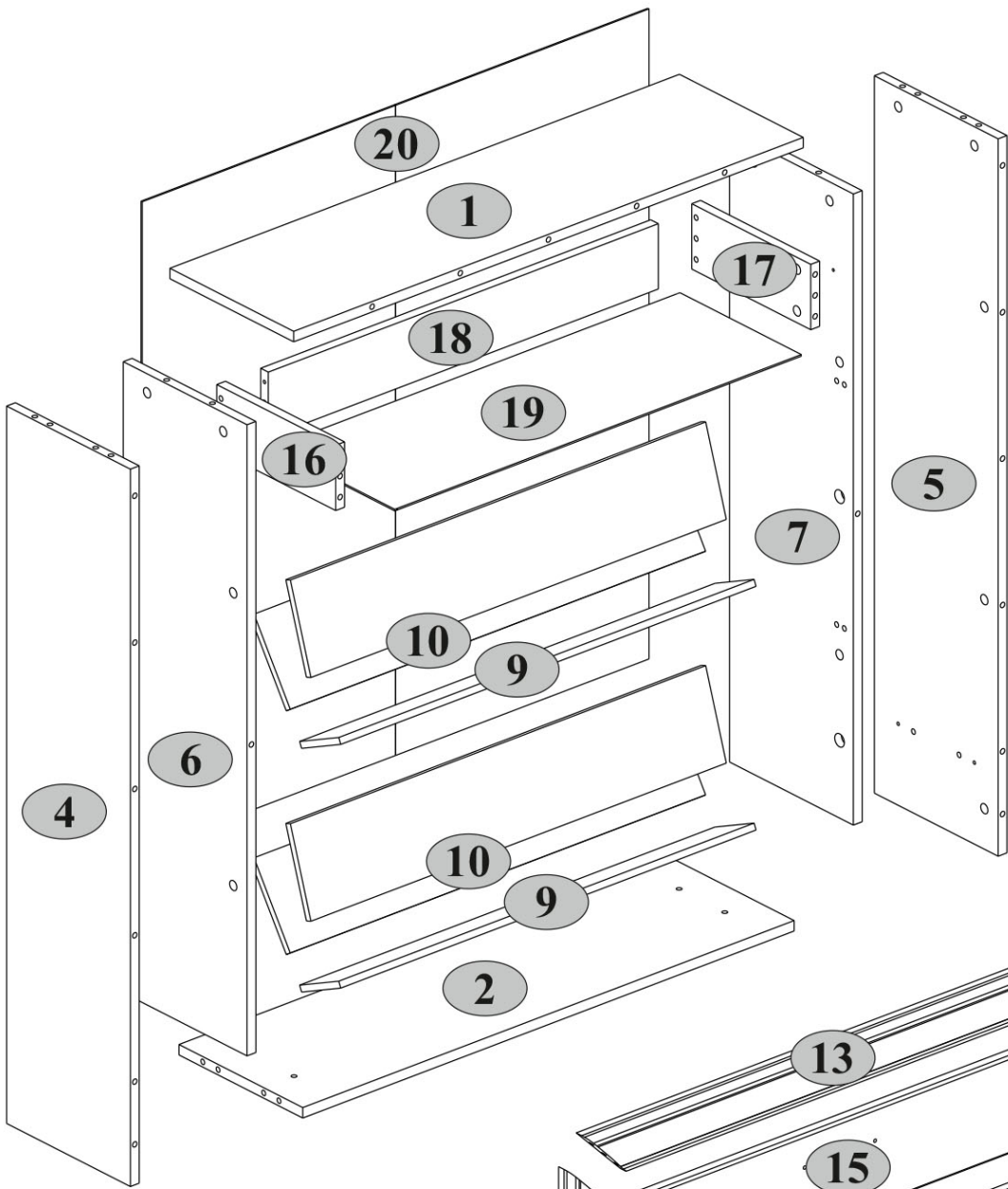
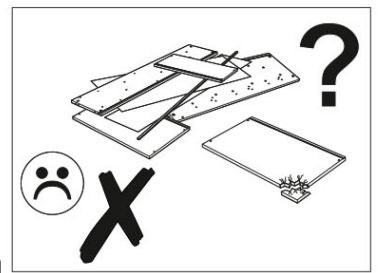

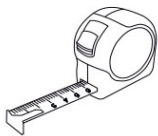
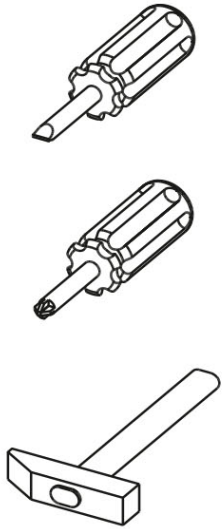
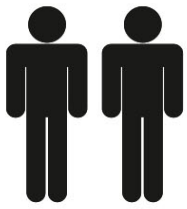



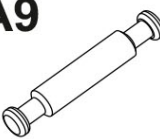

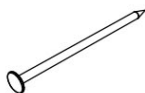

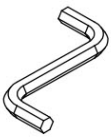
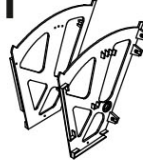

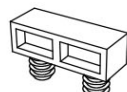
telesných poranení a smrti v dôsledku pádu nábytku:

- Umiestnite najťažšie predmety do spodnej zásuvky
- Neukladajte na hornú časť ťažké predmety
- Nikdy nedovoľte deťom liezť na zásuvky, dverka alebo police
- Nábytok používajte na určený účel



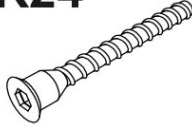



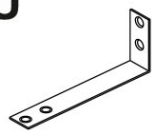
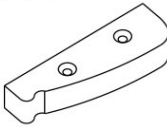
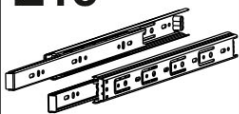

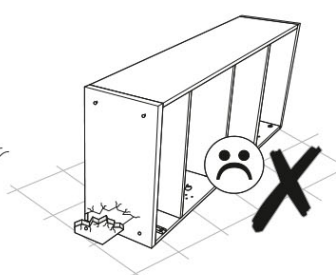
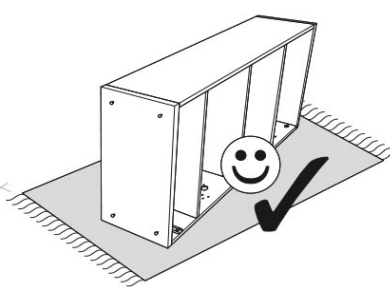
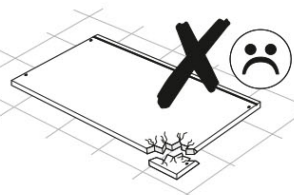
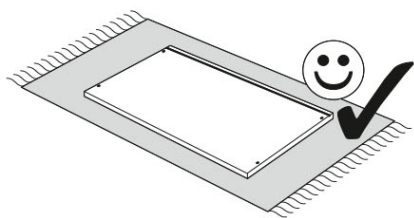
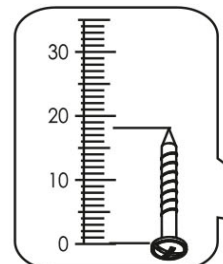
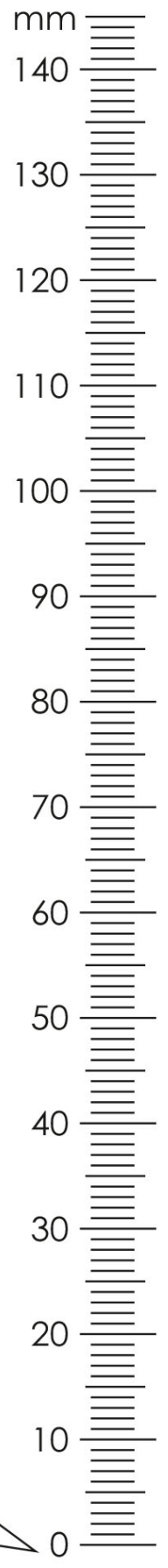

A1.0  5x28 21	A2  15x13 25	A9  L-47,4 2	B5  10x50 1
C1  8x35 34	G  1,5x26 30	H63  3	I  S4 1
J1  2	J2  4	J3  4	J4  4
M4  M4x22 6	N1  4	R1  3x13 12	R3  3x20 8
R5  3x30 4	R19  6,0x13 4	R24  7x50 4	R27  5,0x13 8
R102  3,5x16 14	S5  Ø18 4	U  130x35x15 1	V16  80x25x15 2
Z15  250 1			



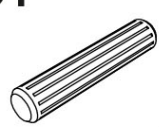

1

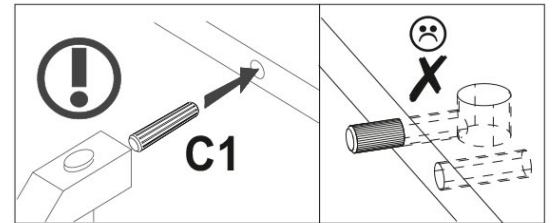
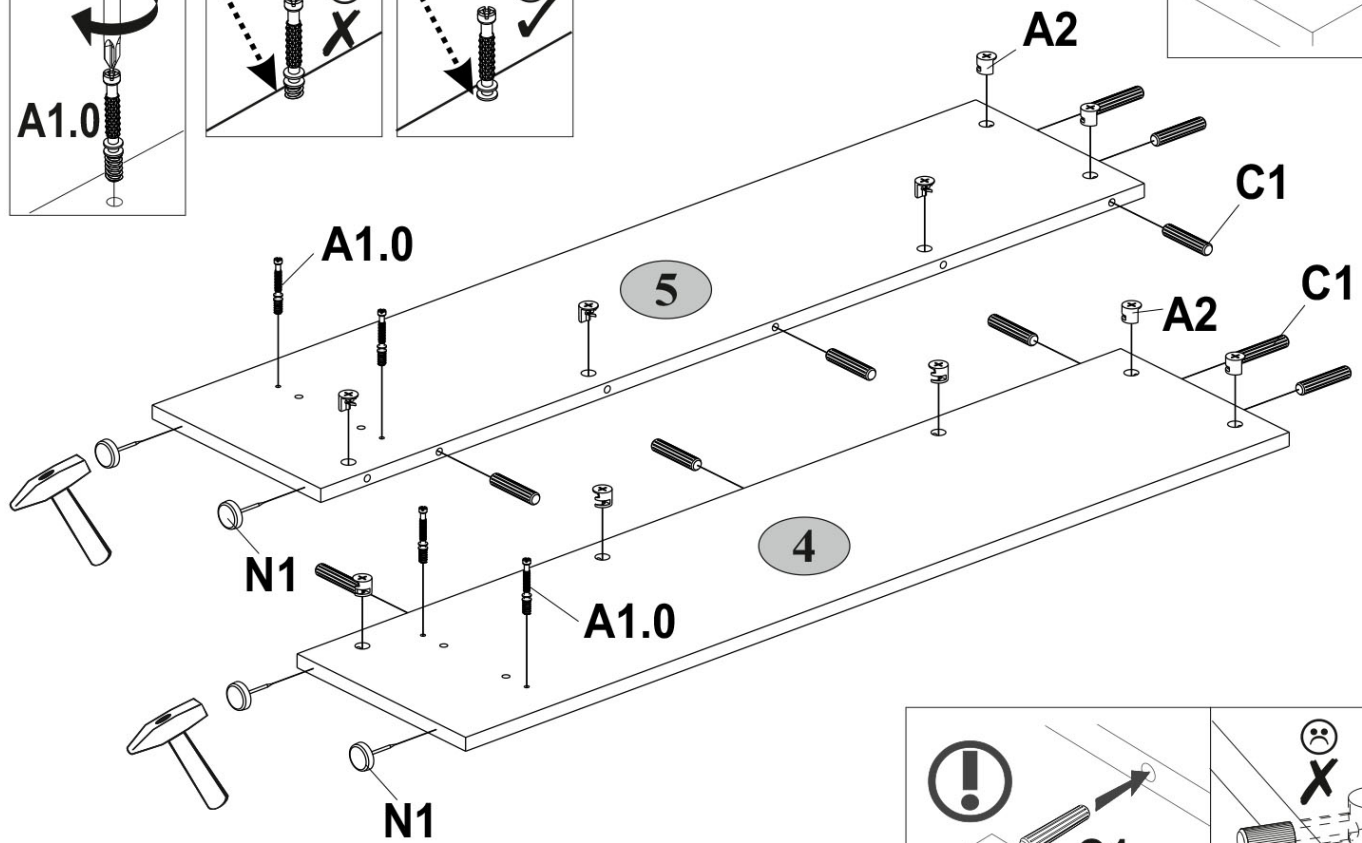
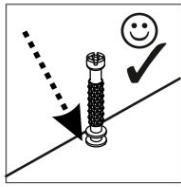
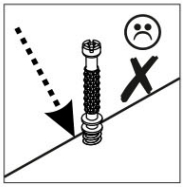
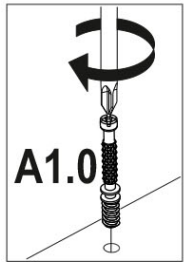
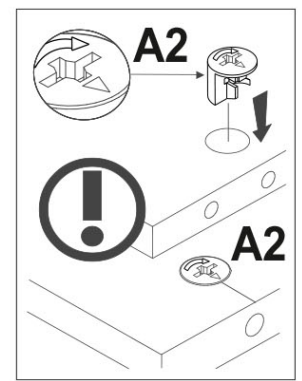
A1.0  5x28	A2  15x13	C1  8x35	N1  4
4	10	10	4



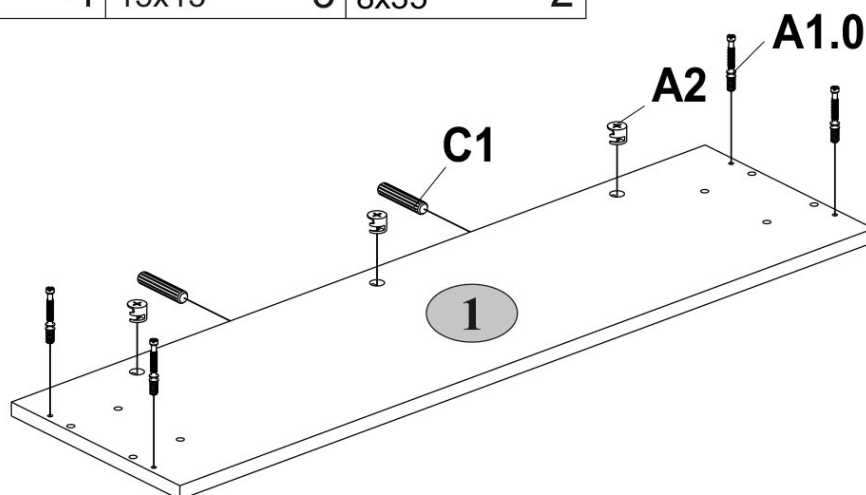

2

A1.0  5x28	A2  15x13	C1  8x35
4	3	2

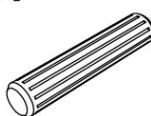

3

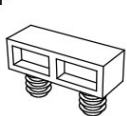
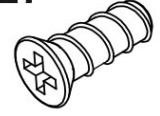
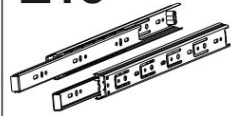
C1  8x35 10	J2  4	J4  4	R27  5,0x13 4	Z15  250 1
--	---	---	--	---

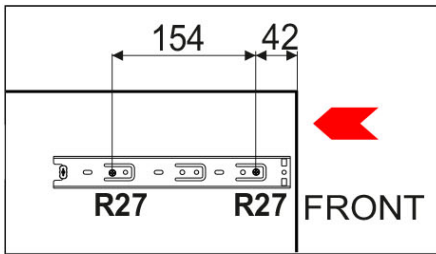
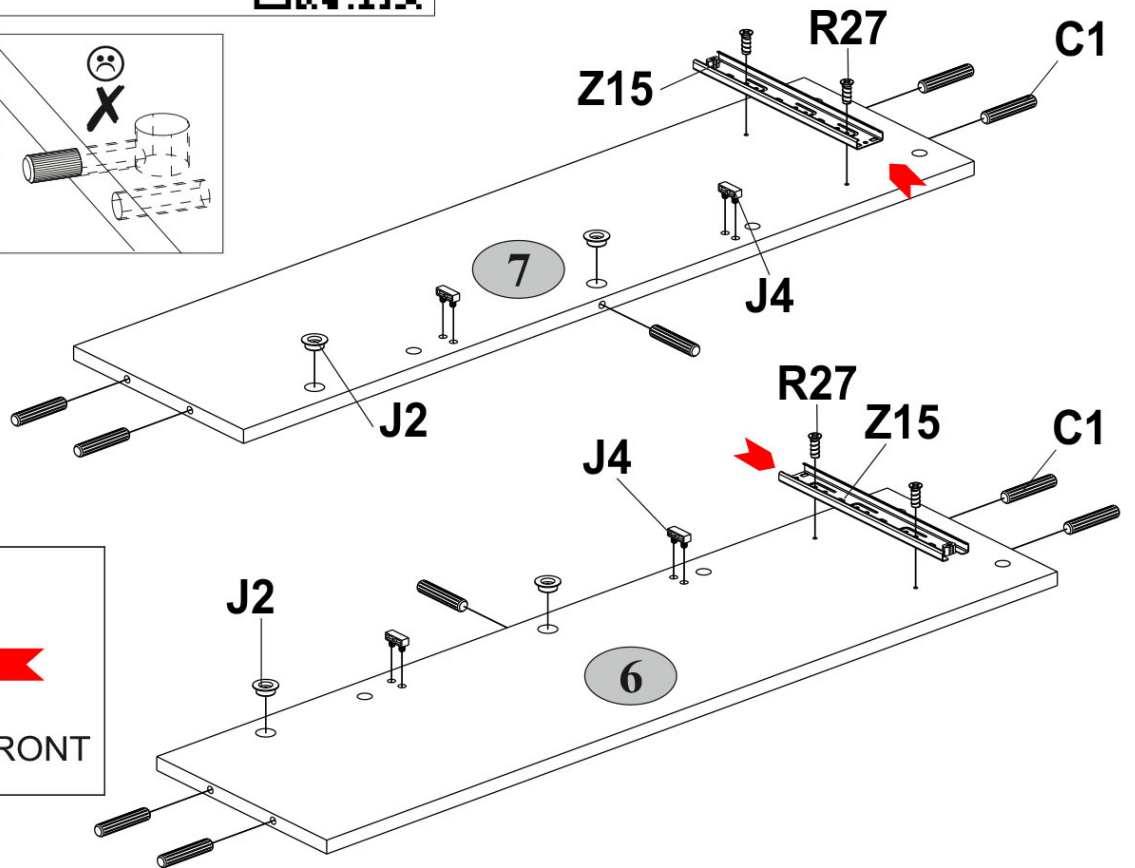
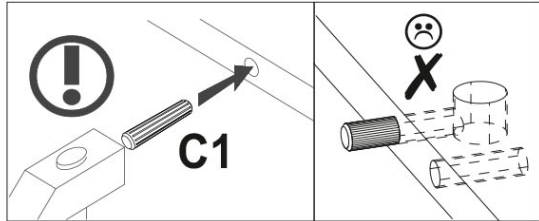
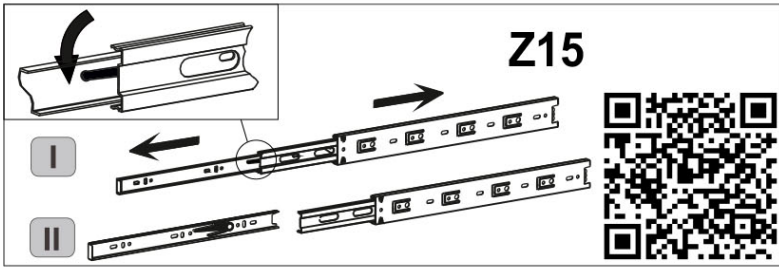

4

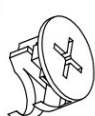
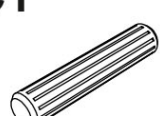
A2  15x13 4	C1  8x35 4
--	---

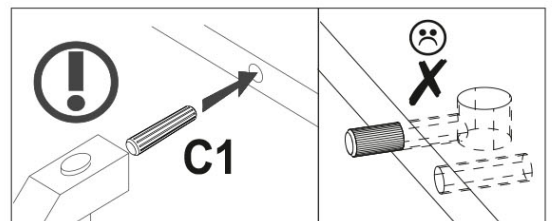
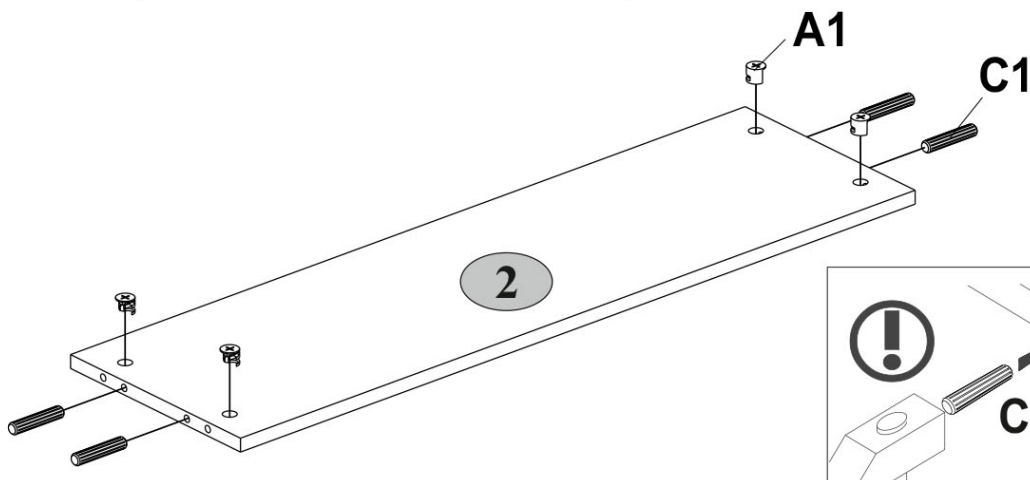
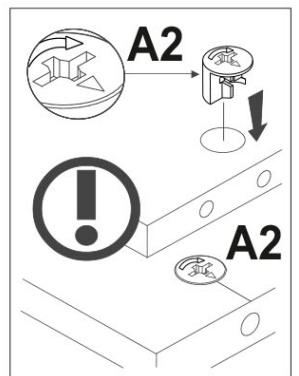

5

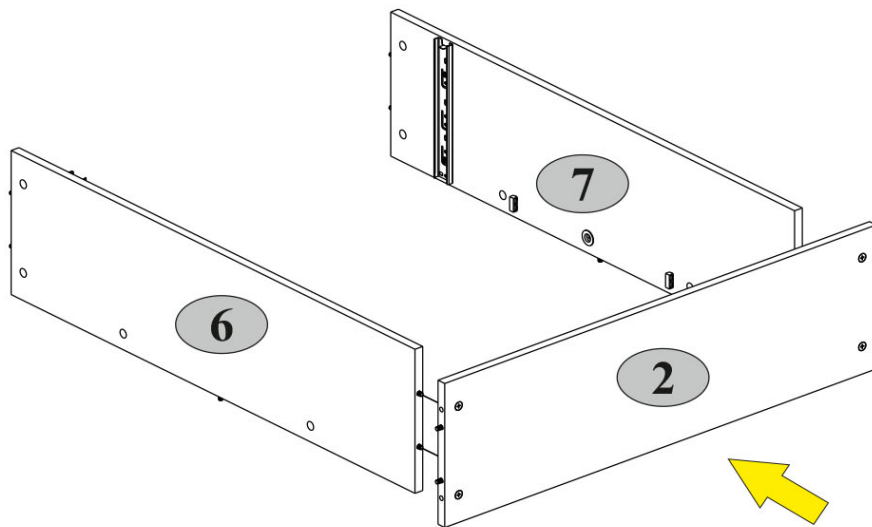

6

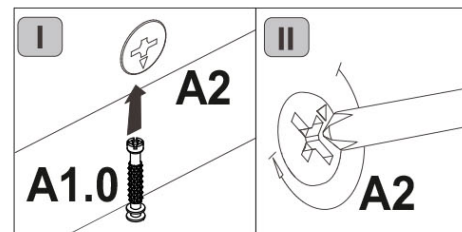
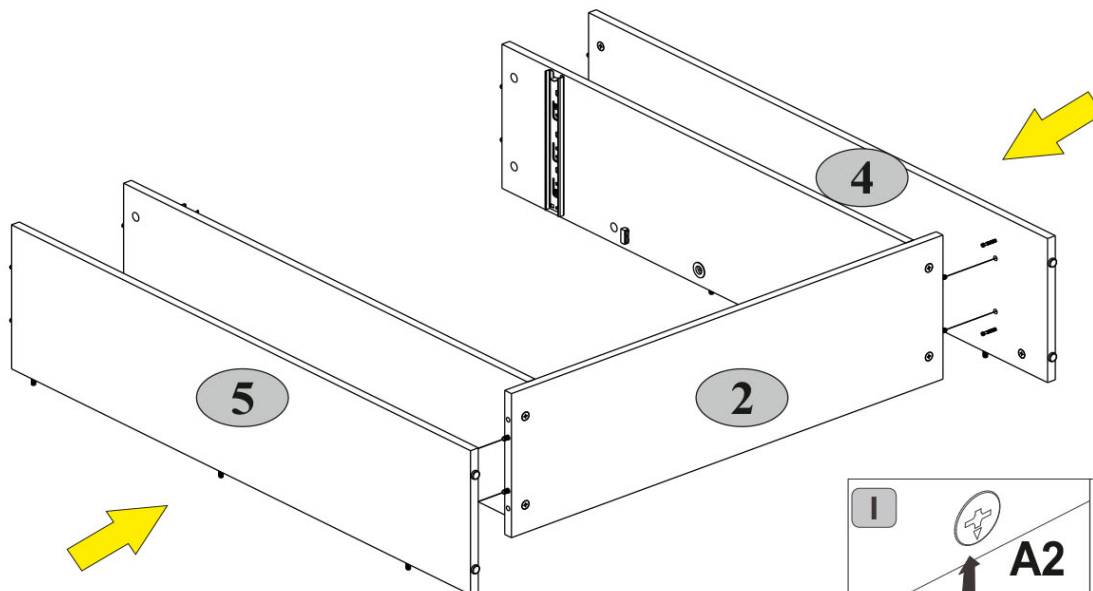

7

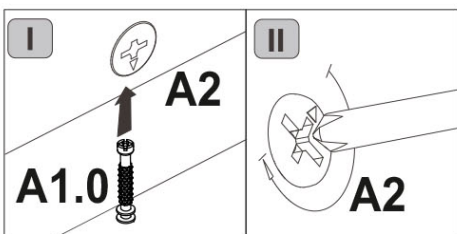
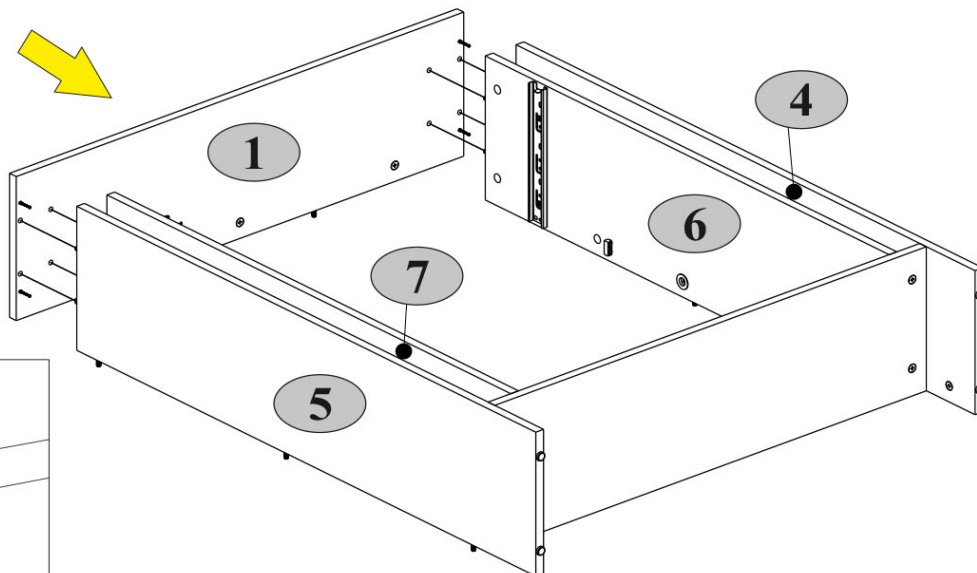
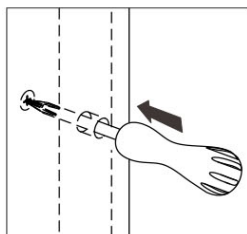

5

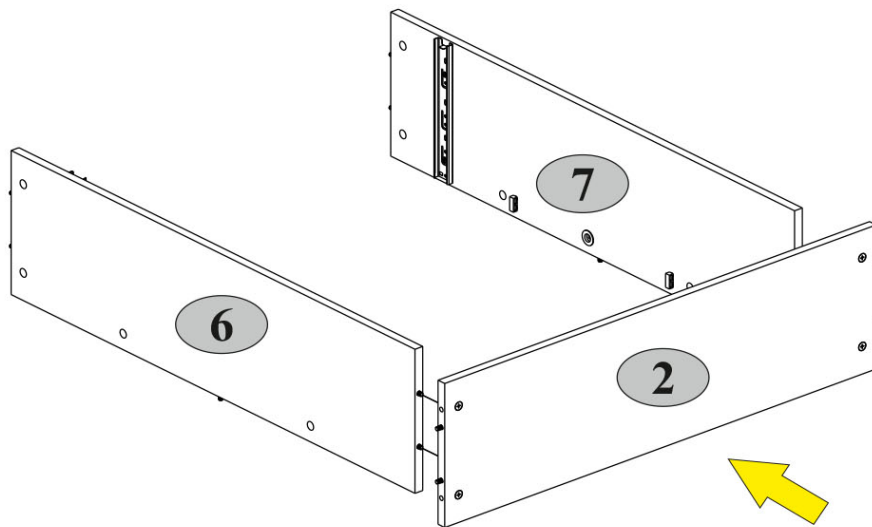

6

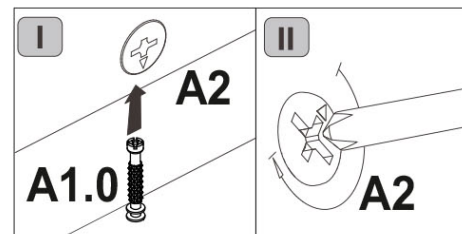
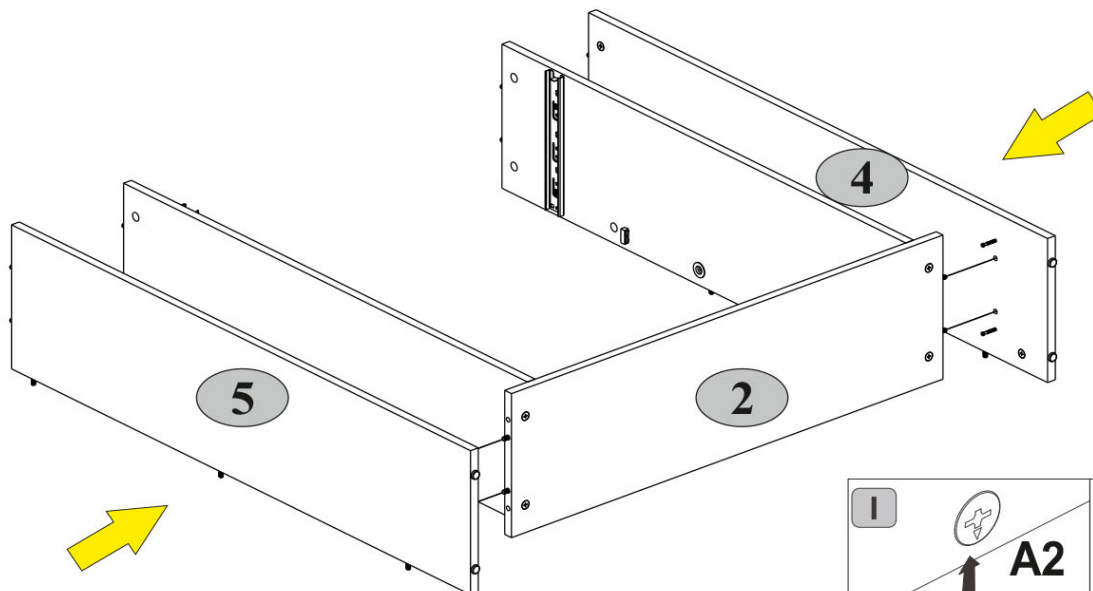

7

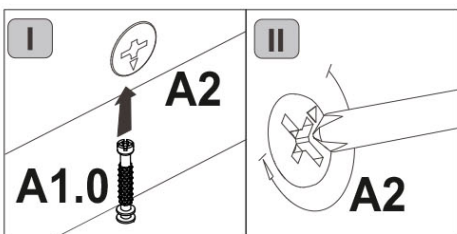
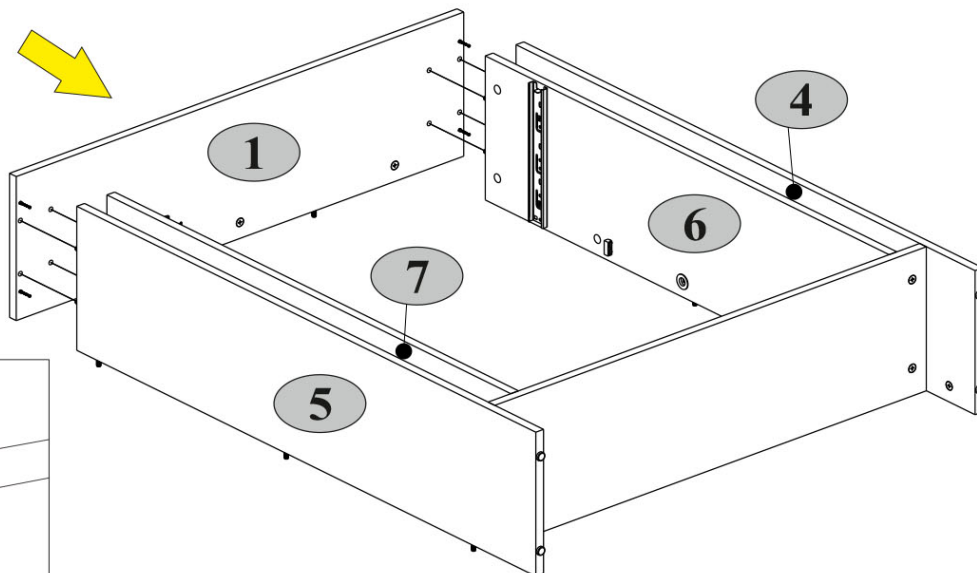
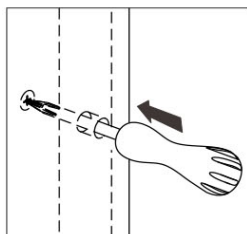

8

G

1,5x26 30

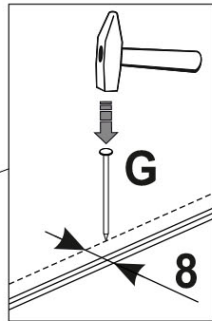

A=B

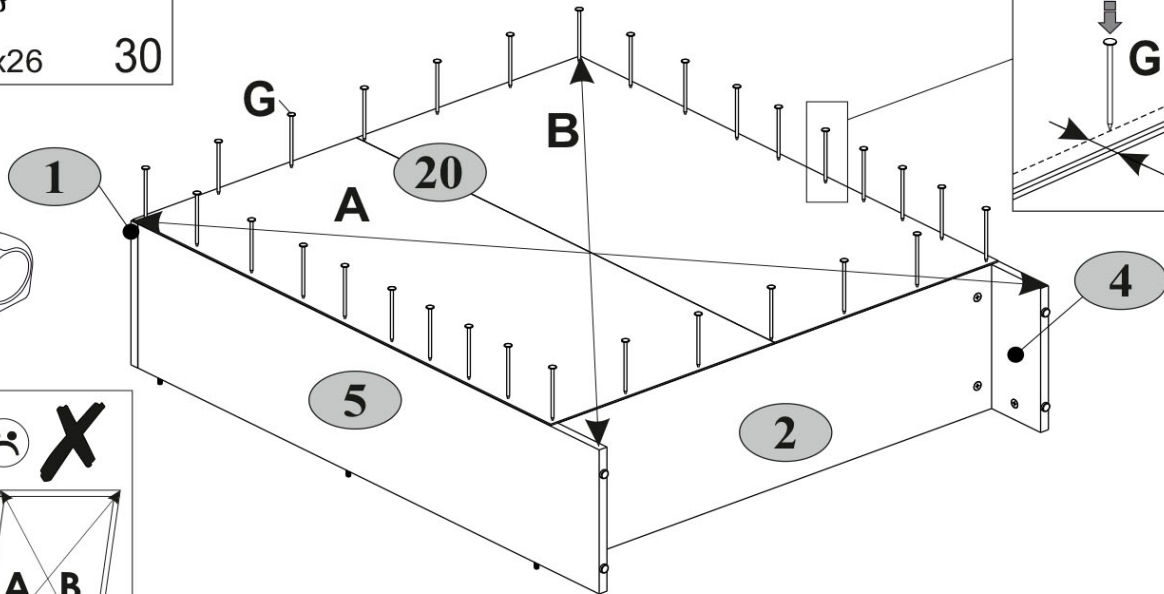
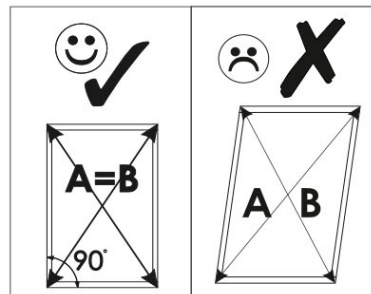
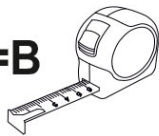

9

A1.0

5x28



A2

9 15x13



A9

L-47,4

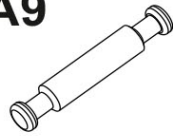

C1

2 8x35



R5

4 3x30



V16

80x25x15 2

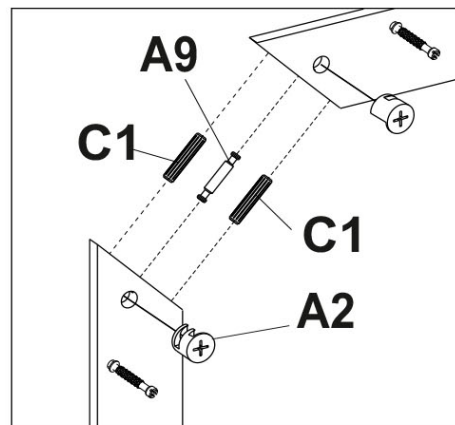
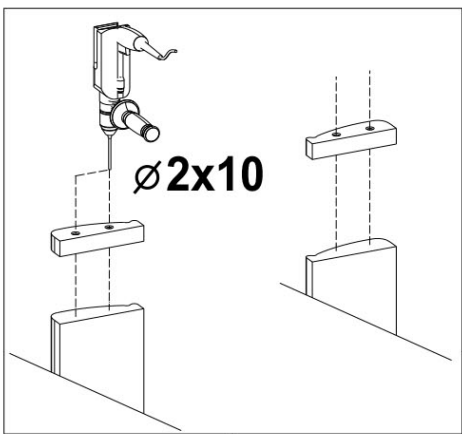
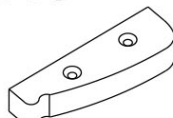

R5 V16

R5 V16

A1.0

11

A1.0

12

A2

A9

A1.0

13

C1

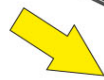
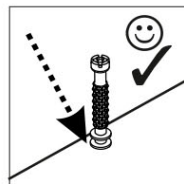
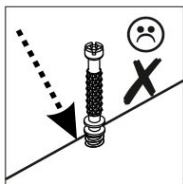
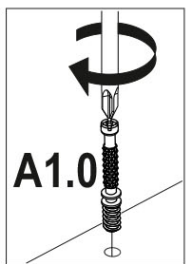

10

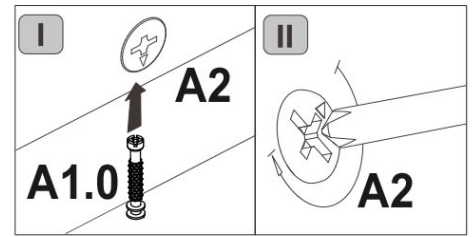
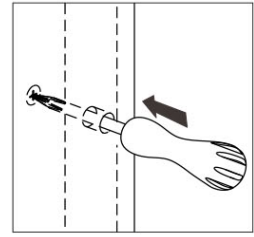
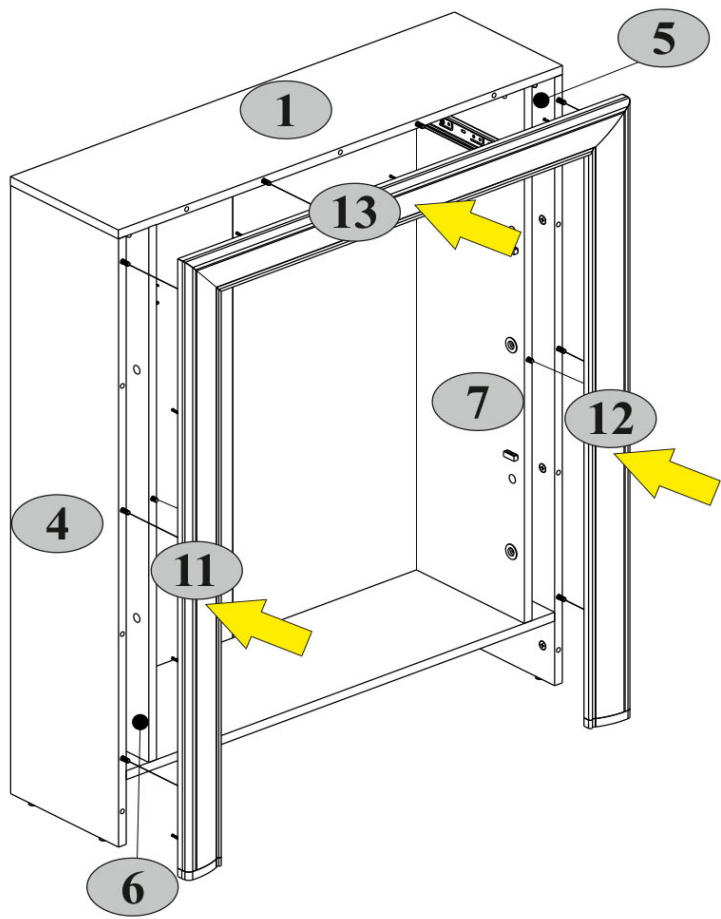

11

x2

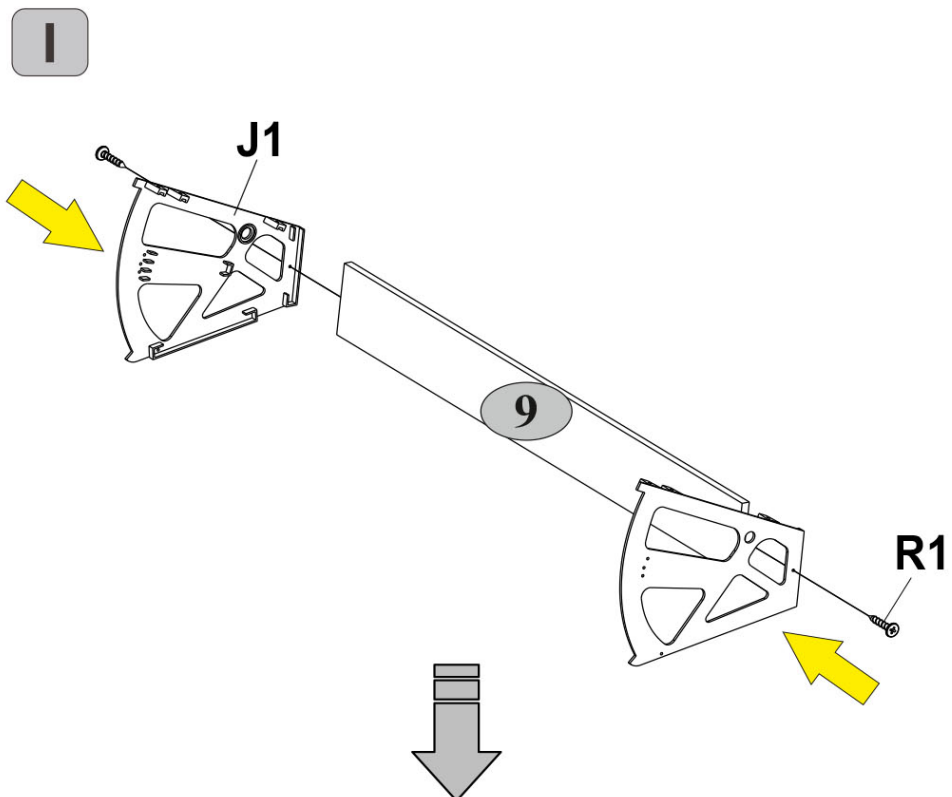
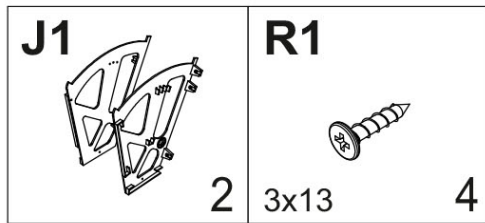

11**x2****H63**

2

M4

M4x22

4

R102

3,5x16

12

R1

3x13

8

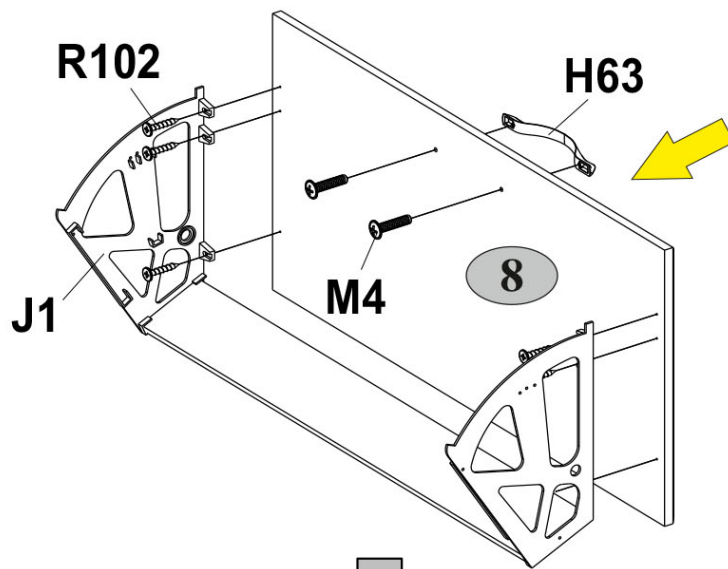
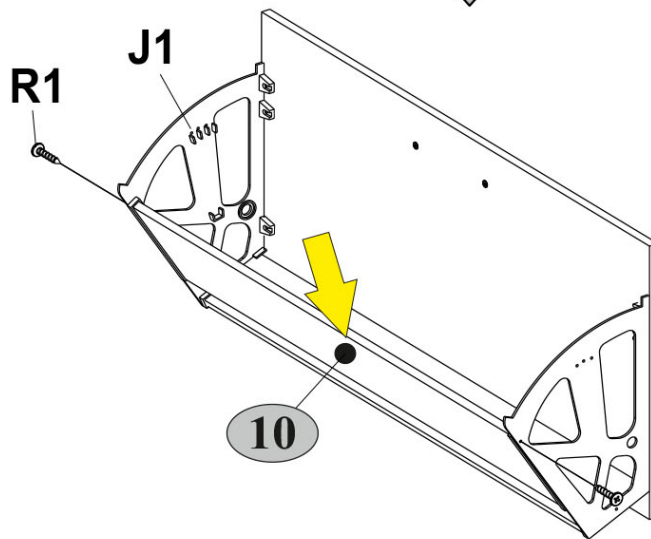
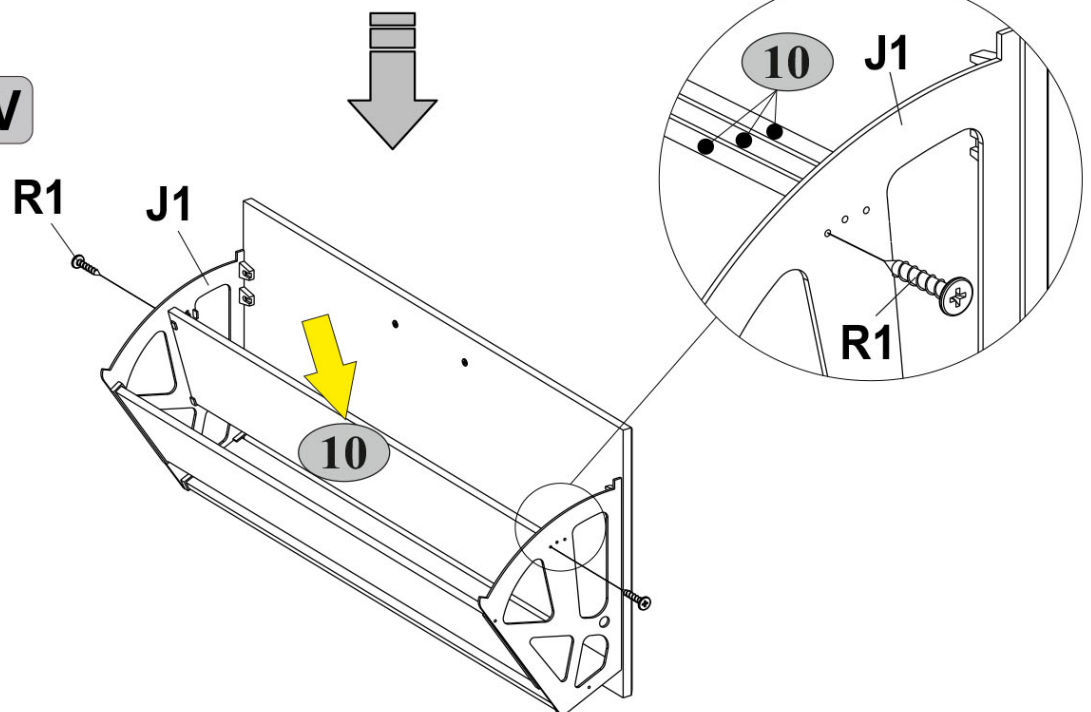
II**III****IV**

12

A1.0 5x28 4	A2 15x13 4	C1 8x35 4	H63 1	I S4 1
M4 M4x22 2	R24 7x50 4	R27 5,0x13 4	S5 Ø18 4	Z15 250 1

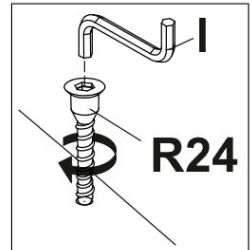
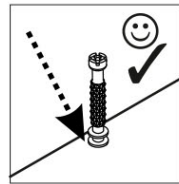
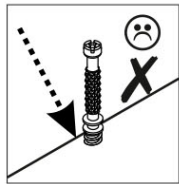
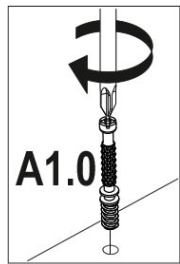
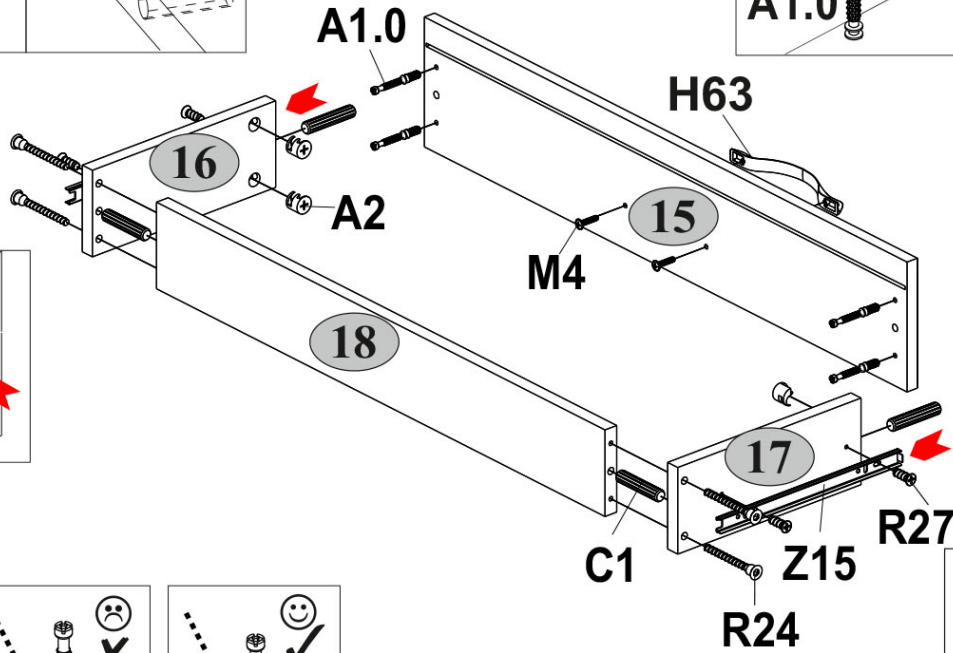
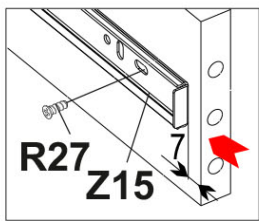
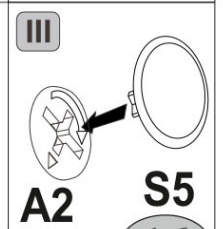
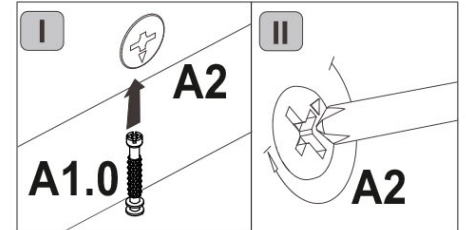
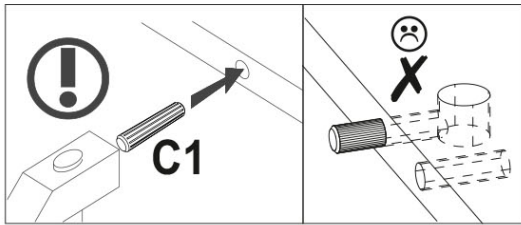

13

R3 3x20 8

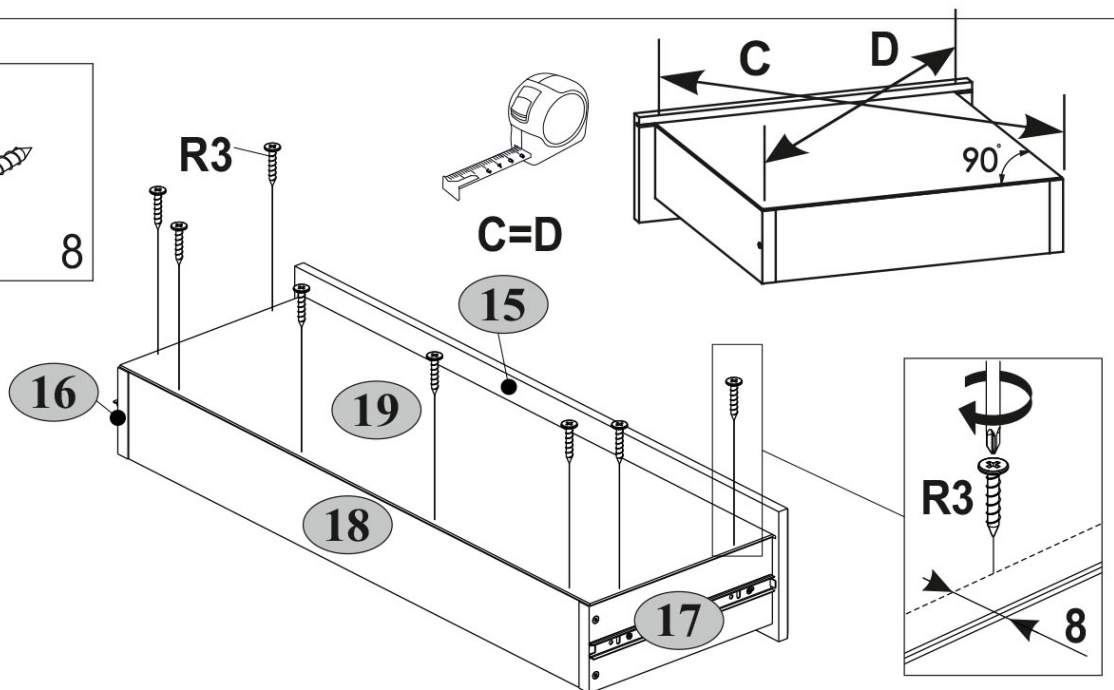

14

J3



4

R19



6,0x13

4

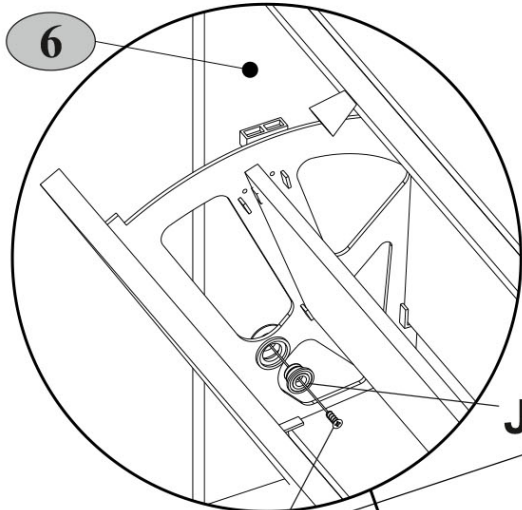



J3

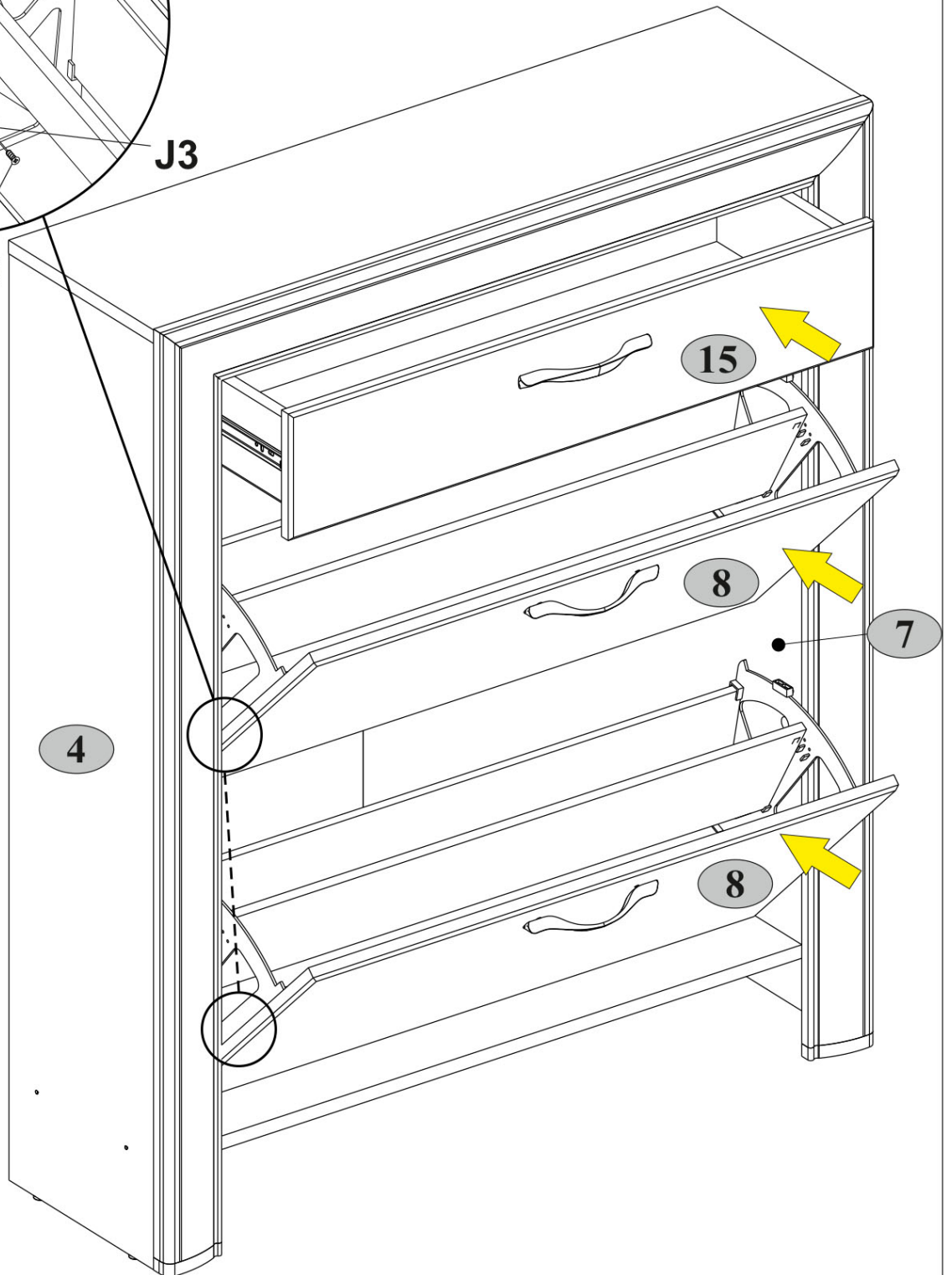

R19

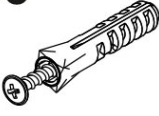

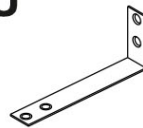
15

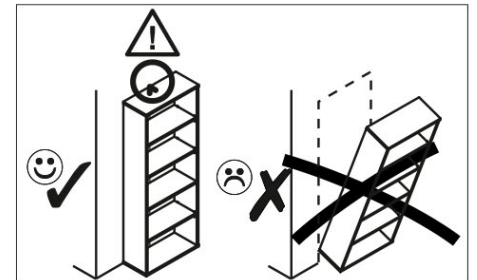
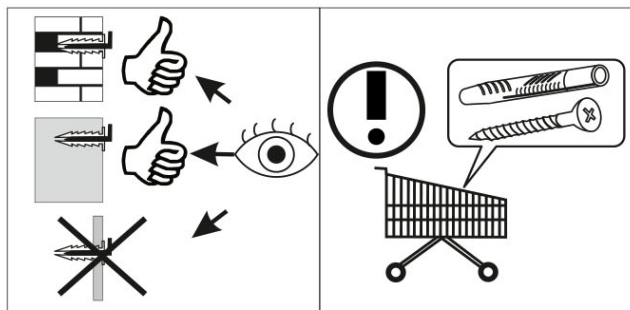
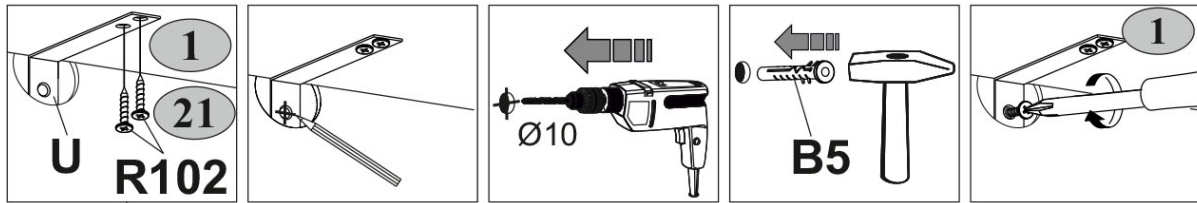
B5  10x50 1	R102  3,5x16 2	U  130x35x15 1
--	---	---



- 8**  max 3 kg
- 15**  max 5 kg
- 1**  max 10 kg