

# ASSEMBLY INSTRUCTION FOR PSN B3-832W-32UNS (LOZKO VENEČJA)

**Note**

- Read instructions carefully.
- Check to verify each component against those shown in the picture.
- Separate and label each component from the package packaging and store it in separate plastic bags.
- Do not over-tighten the screws or adjust parts assembly.



2 Persons

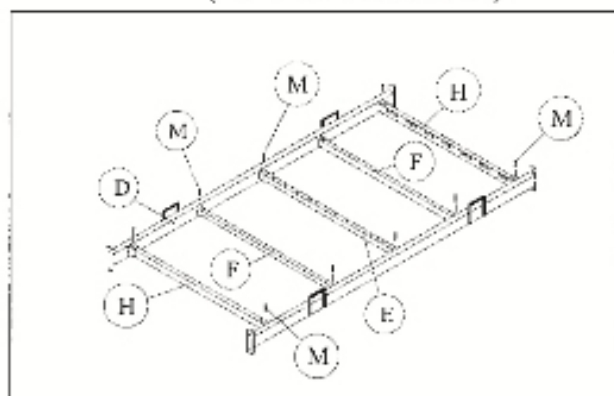

**Step 1** Fix both side rails and cross bar 'E' with bolt 'M' as above diagram. Put cross bar 'F' into side rail and fix in bolt 'M'. After that put end cross bar 'H' to the end of side rail and tighten with bolt 'M'.

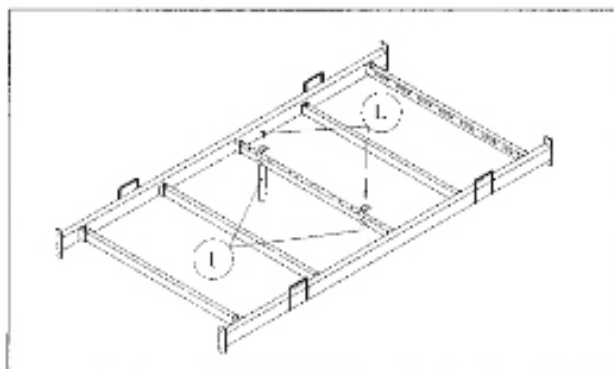

**Step 2** Fix bed support legs as shown on the picture.

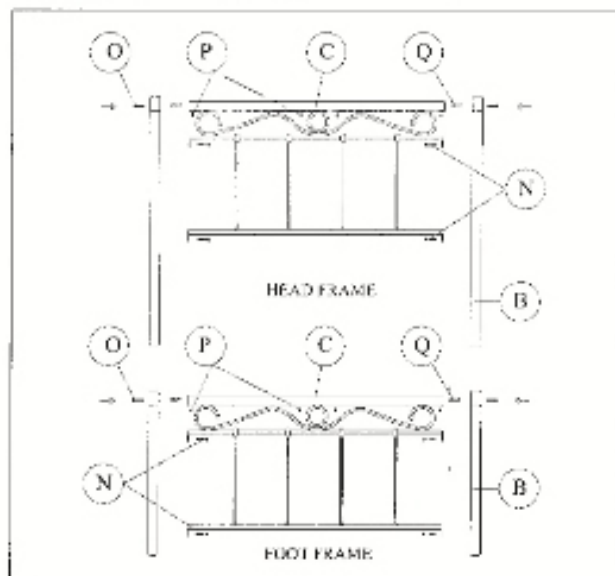

**Step 3** Fix in bolt 'M' into head and foot frame.

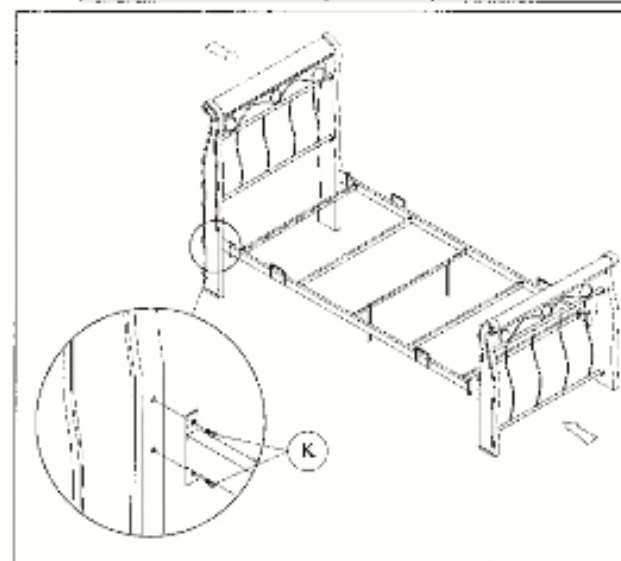



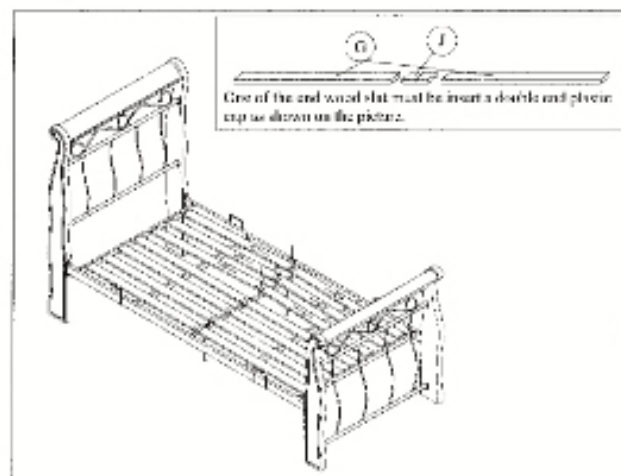

















**Step 4** Assemble bed base into bed frame and tighten all bolts.

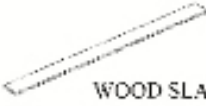

**Step 5** Once wood slats have been inserted into the plastic caps, fix one end of wood slat into the hole of end cross bar 'F' and the other end to the other end cross bar. After that fix the plastic cap to the center cross bar by pressing it accordingly to the default holes. Ensure the plastic cap's pin aimed to the hole.

Please follow our Assembly Instruction procedure for easier assemble.

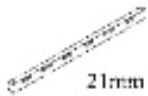
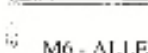
## HARDWARE & PART LIST FOR PSN B3-832W-32NS (LOZKO VENEČJA)

NO	PART	QTY	NO	PART	QTY
A	 HEAD FRAME	1 pc	I	 SUPPORT LEG	2 pcs
	 FOOT FRAME	1 pc	J	 Double end plastic cap	7 pcs
B	 HEAD POST	2 pcs	K	 M8x25mm	8 pcs
	 FOOT POST	2 pcs		L	 M8x40mm (assembled)
C	 TOP BAR	2 pcs	M	 M6x40mm (assembled)	10 pcs
D	 SIDE RAIL	2 pcs	N	 M6x25mm	8 pcs
E	 1" x 1" CROSS BAR	1 pc	O	 M6x50mm	4 pcs
F	 21mm x 30mm CROSS BAR	2 pcs	P	 CHIPBOARD SCREW #3.5 x 16mm	8 pcs
G	 WOOD SLAT	14 pcs	Q	 WOOD DOWEL M8 x 30mm	4 pcs
H	 21mm x 30mm CROSS BAR	2 pcs		 M6 - ALLEN KEY	1 pc
				 M8 - ALLEN KEY	1 pc