

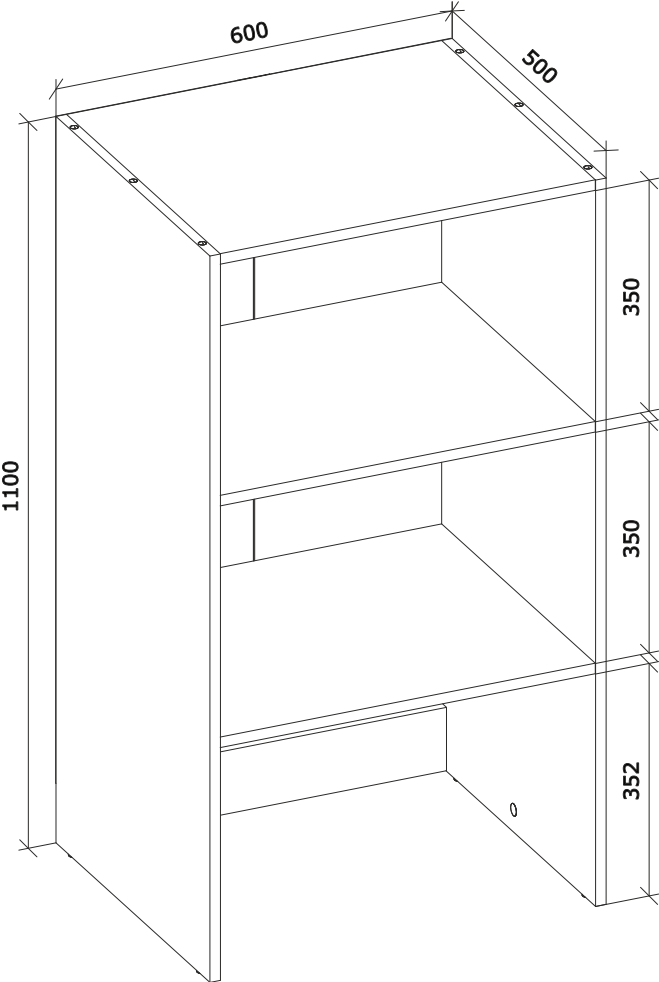













(EN) Assembly instructions

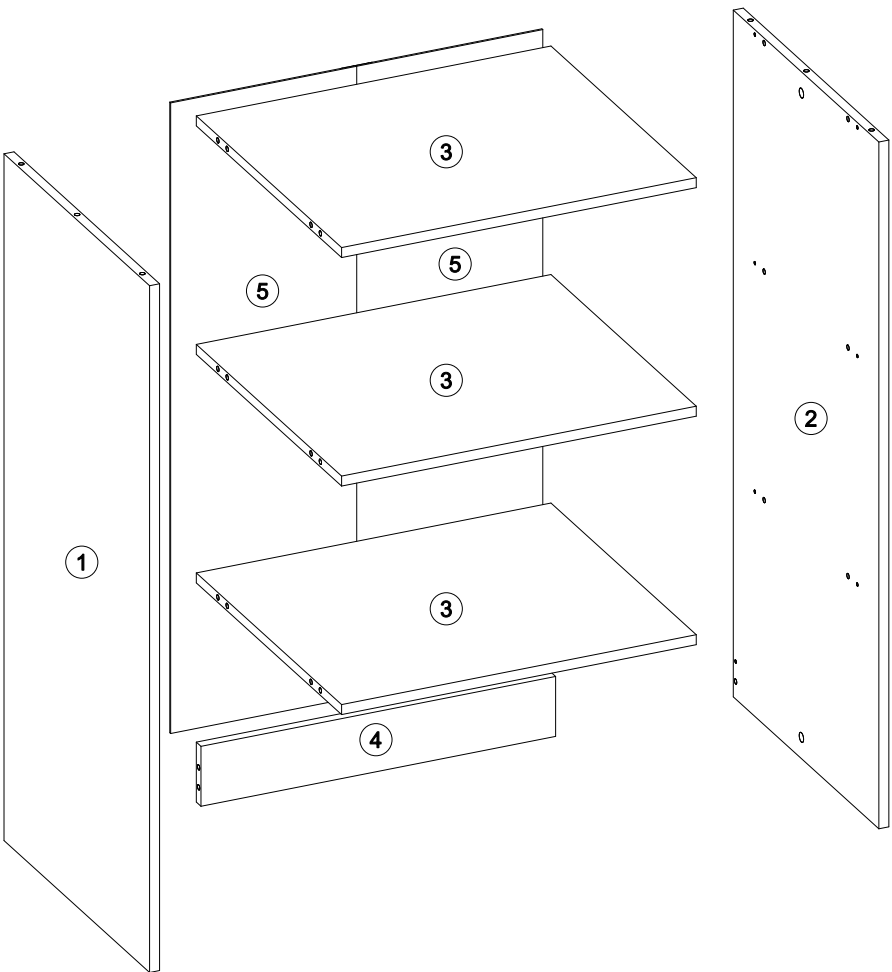

C x 38	 1.6x20	D5 x 2		I x 16	 8x30
Mz x 16		M x 16		MB x 14	
Mb2 x 1		N x 4		Lz x 6	
Mzs x 2		S1 x 2	 3.5x16	Pz x 1	

№	pcs	size, MM		
		1100	500	16
1	1	1100	500	16
2	1	1100	500	16
3	3	568	499	16
4	1	568	96	16
5	2	1010	298	3



	<p>UZWANBLU. Mitteln, um Gefahren vor dem Zusammenbau zu vermeiden. Lesen Sie die Anweisungen sorgfältig durch. Beachten Sie die Warnhinweise. Achten Sie auf die Sicherheitshinweise. Beachten Sie die Anweisungen des Herstellers. Beachten Sie die Anweisungen des Herstellers. Beachten Sie die Anweisungen des Herstellers.</p>	<p>IT AVVERTENZA Informazioni importanti. Leggere attentamente. Prestare particolare attenzione per ulteriori avvertenze.</p>	<p>GB WARNING Important information. Read carefully. Keep this information for future reference.</p>	<p>DE ACHTUNG Wichtige Information. Sorgfältig lesen. Diese Information für später verwenden.</p>	<p>PL UWAGA Ważna informacja. Przeczytaj uważnie. Zachowaj informacje na przyszłość.</p>	<p>CZ VAROVÁNÍ Důležitá informace. Učte pozorně. Uložte tyto poznámky pro případ potřeby.</p>	<p>FR AVERTISSEMENT Risque de blessure grave en cas de chute du produit. Lire attentivement les instructions avant de commencer l'installation. Lire attentivement les instructions avant de commencer l'installation.</p>	<p>NL WAARSCHUWING Let op het risico van ernstige verwondingen bij het opzetten van de meubel. Lees de instructies aandachtig door. Lees de instructies aandachtig door.</p>	<p>RU ВНИМАНИЕ Важная информация. Прочтите внимательно. Сохраните эту информацию на будущее.</p>	<p>SE VARNING Viktig information. Läs noggrant. Spara informationen för framtida bruk.</p>	<p>RO ATENȚIE Pozi sunteți atenți pentru prevenirea accidentelor. Cititi cu atenție instrucțiunile înainte de a începe montajul.</p>	<p>UA УВАГА Важлива інформація. Прочитайте уважливо. Збережіть цю інформацію на майбутнє.</p>	<p>ES ADVERTENCIA Pueden producirse lesiones graves si cae este mueble. Debe fijarse permanentemente a la pared.</p>	<p>HR OPREZNOŠĆE Ako se namještaljka prevrne može doći do ozbiljnih povreda. Namještaljku morate biti pričvrstili na zid.</p>	<p>SK OPREZNOŠŤ Akým nárazom alebo pádom môže dôjsť k vážnym zraneniam. Nábytok musí byť prichytený na stenu.</p>	<p>BY ВНИМАНИЕ Прыкладанне на стан будытоў можа прывесці да цяжкіх параненняў. Будытоў трэба замацаваць на сцяне.</p>	<p>HU FIGYELME A súlyos sérülések veszélye van, ha a termék lefordul. A terméknek rögzítenie szükséges a falra.</p>	<p>EU ВНИМАНИЕ Напомена: ако мебел падете може да доведе до сериозни повреди. Прочетете внимателно инструкциите преди да започнете с монтажа.</p>	<p>UA УВАГА Напомена: якщо мебел перевернеться, це може призвести до серйозних поранень. Прочитайте уважливо інструкції перед початком монтажу.</p>	<p>DK ADVARSEL Der kan opstå alvorlige eller livsfarlige skader, hvis møbelstykket vælter. Det skal fastgøres permanent til væggen.</p>	<p>GR ΠΡΟΕΙΔΟΠΟΙΗΣΗ Εάν η συσκευή ανατραπεί, μπορεί να προκαλέσει σοβαρά τραυματισμούς. Η συσκευή πρέπει να στερεωθεί μόνιμα στον τοίχο.</p>	<p>GR ΠΡΟΕΙΔΟΠΟΙΗΣΗ Εάν η συσκευή ανατραπεί, μπορεί να προκαλέσει σοβαρά τραυματισμούς. Η συσκευή πρέπει να στερεωθεί μόνιμα στον τοίχο.</p>	<p>GR ΠΡΟΕΙΔΟΠΟΙΗΣΗ Εάν η συσκευή ανατραπεί, μπορεί να προκαλέσει σοβαρά τραυματισμούς. Η συσκευή πρέπει να στερεωθεί μόνιμα στον τοίχο.</p>	<p>GR ΠΡΟΕΙΔΟΠΟΙΗΣΗ Εάν η συσκευή ανατραπεί, μπορεί να προκαλέσει σοβαρά τραυματισμούς. Η συσκευή πρέπει να στερεωθεί μόνιμα στον τοίχο.</p>	<p>GR ΠΡΟΕΙΔΟΠΟΙΗΣΗ Εάν η συσκευή ανατραπεί, μπορεί να προκαλέσει σοβαρά τραυματισμούς. Η συσκευή πρέπει να στερεωθεί μόνιμα στον τοίχο.</p>	<p>GR ΠΡΟΕΙΔΟΠΟΙΗΣΗ Εάν η συσκευή ανατραπεί, μπορεί να προκαλέσει σοβαρά τραυματισμούς. Η συσκευή πρέπει να στερεωθεί μόνιμα στον τοίχο.</p>	<p>GR ΠΡΟΕΙΔΟΠΟΙΗΣΗ Εάν η συσκευή ανατραπεί, μπορεί να προκαλέσει σοβαρά τραυματισμούς. Η συσκευή πρέπει να στερεωθεί μόνιμα στον τοίχο.</p>
---	---	---	--	---	--	---	--	--	--	--	--	---	--	---	---	---	---	---	---	---	--	--	--	--	--	--	--

