





1

4.0x35mm		
	R3	F4
20		10



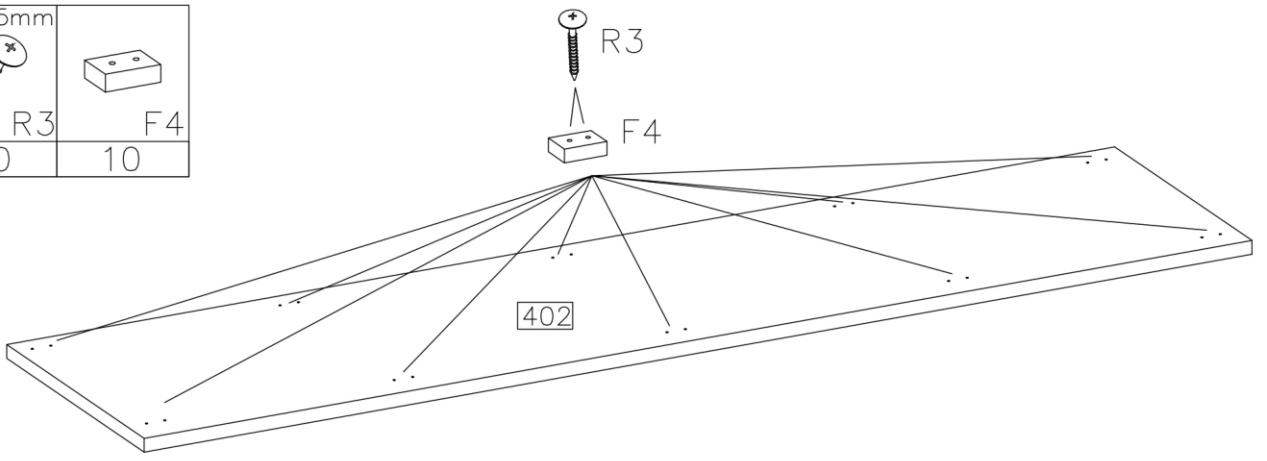

2

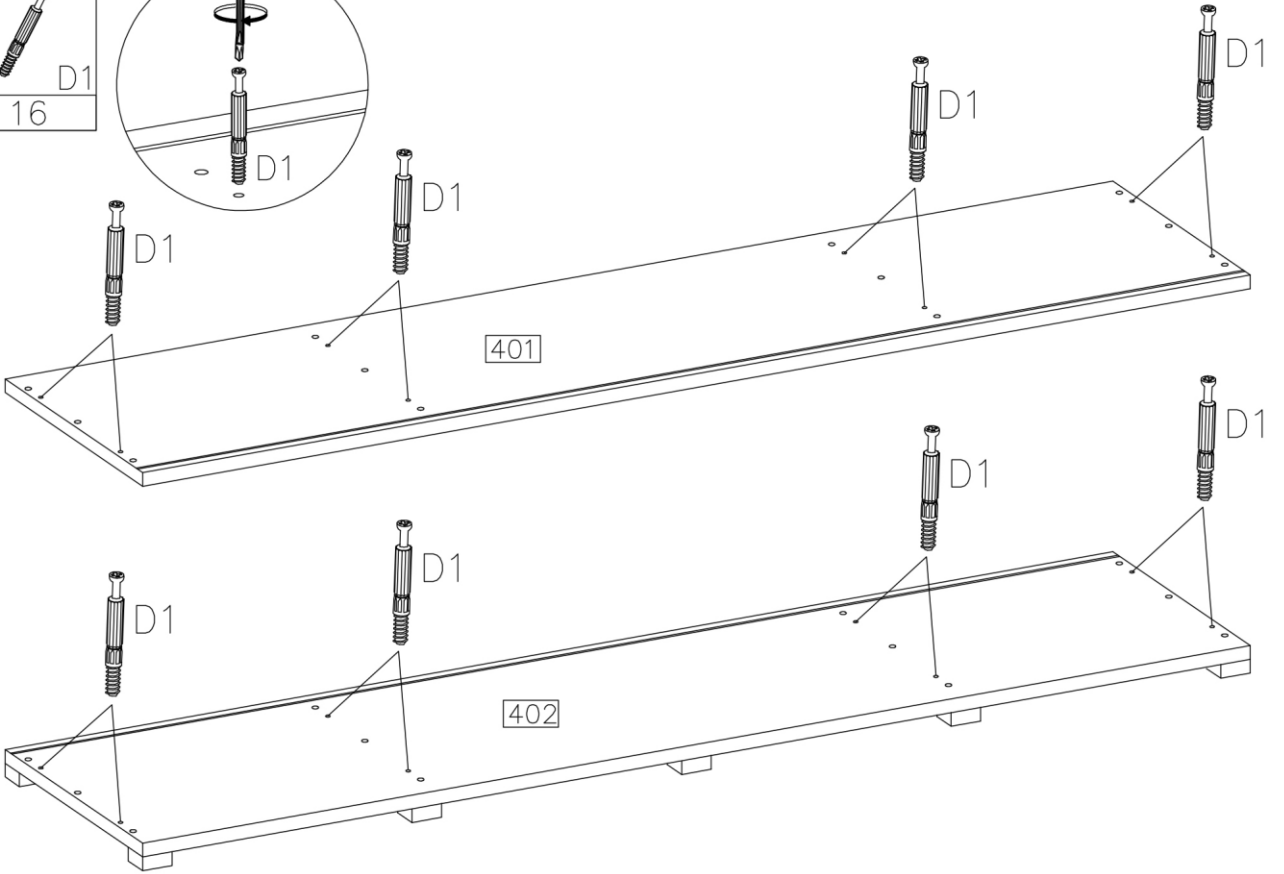
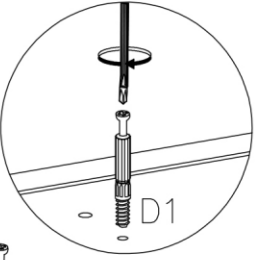
	D1
16	



3

$\varnothing 15/12\text{mm}$	$\varnothing 8 \times 30\text{mm}$
	
C	A
16	24



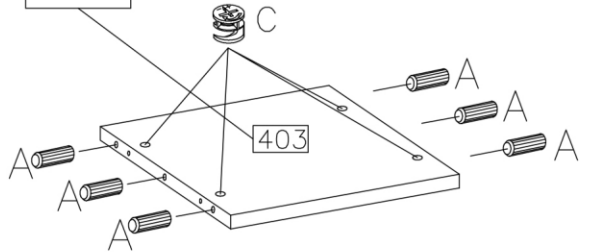

2x

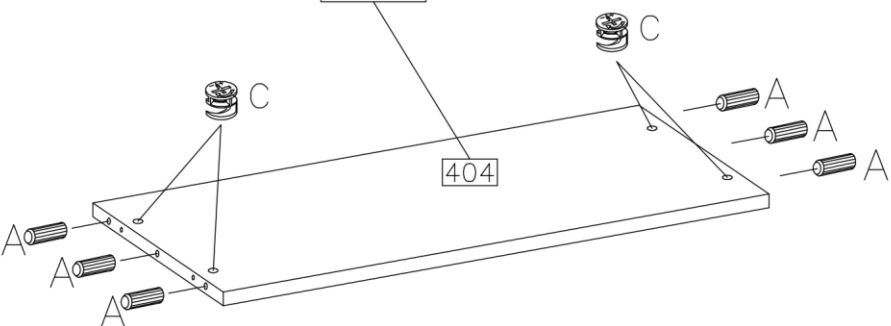

2x







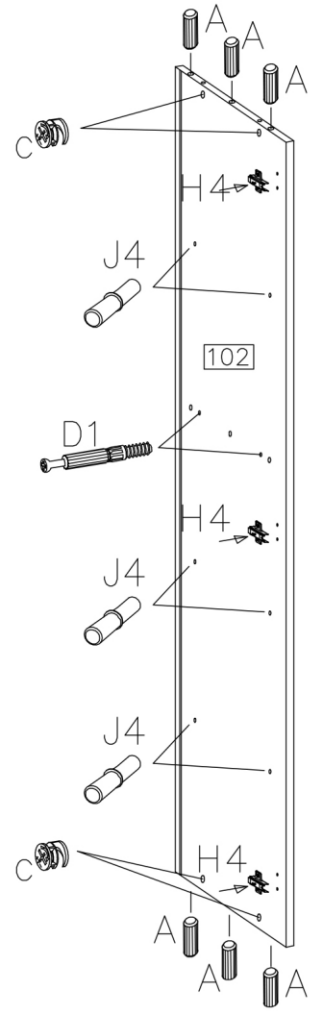
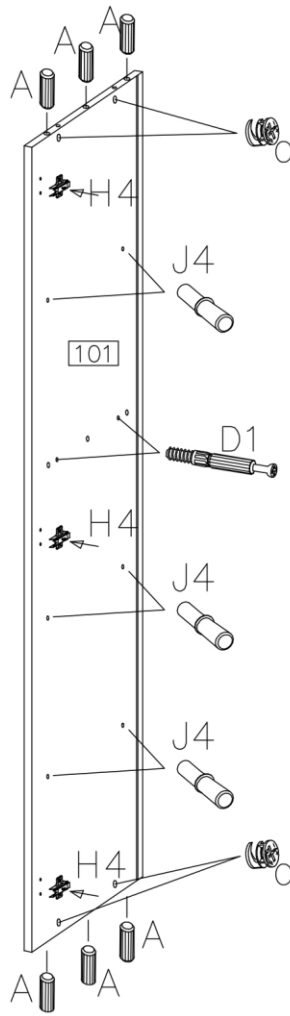
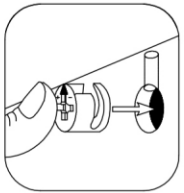

4

 D1	 A
4	12
 H4	 J4
6	12
 C	
8	



5

 D1	 A
12	12
 H4	 O10
6	2
 P2	 C
4	8

 J4
12

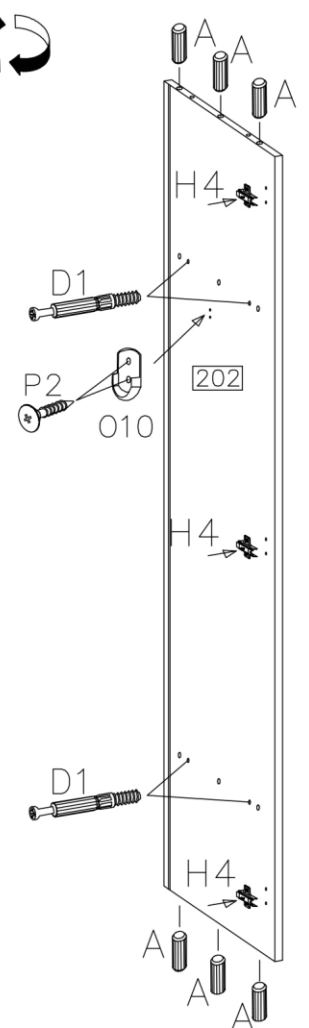
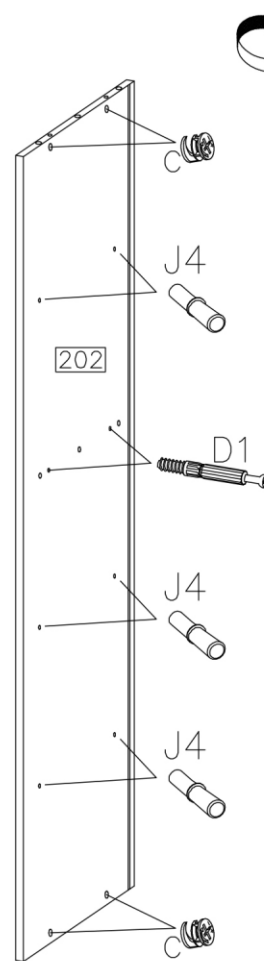
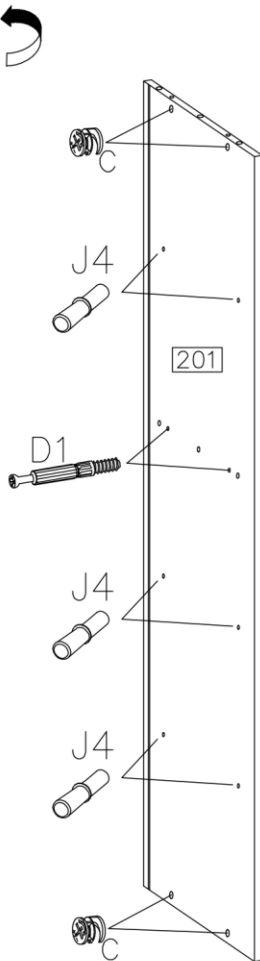
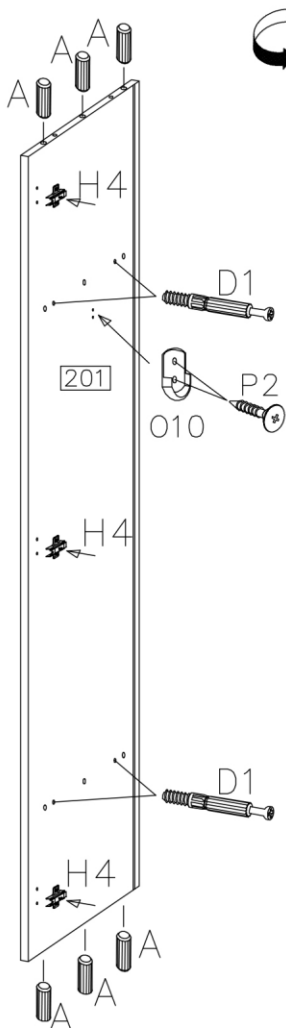

6

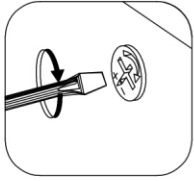
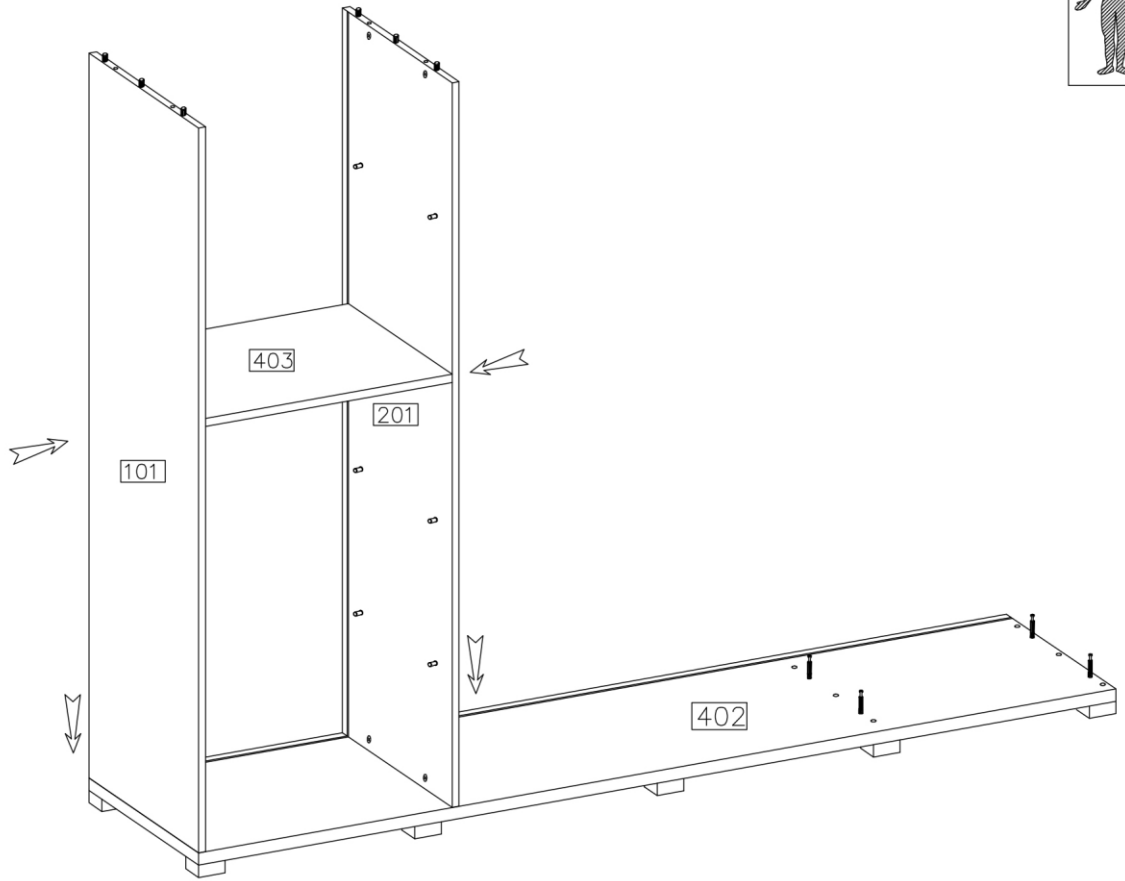
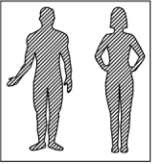
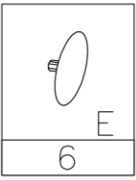

7

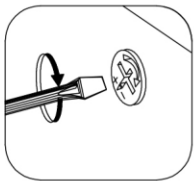
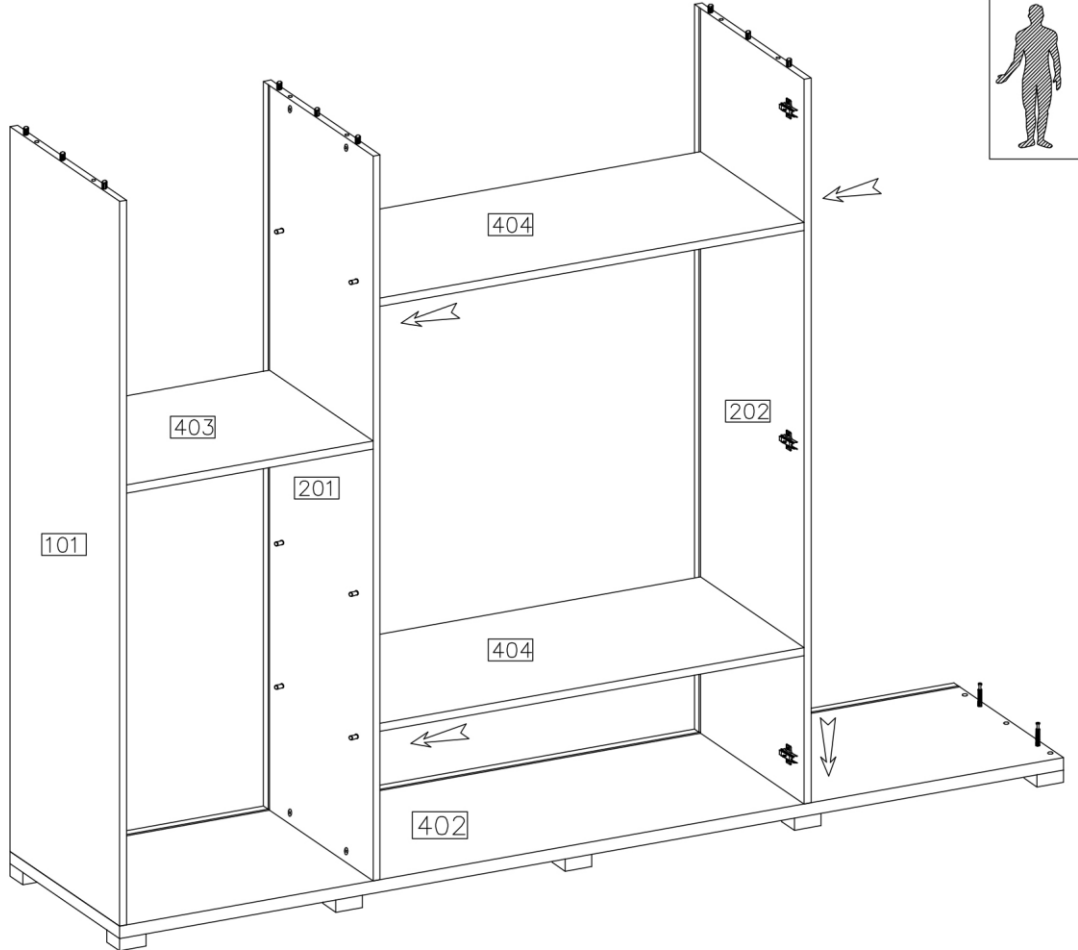
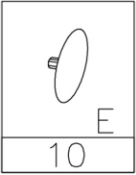

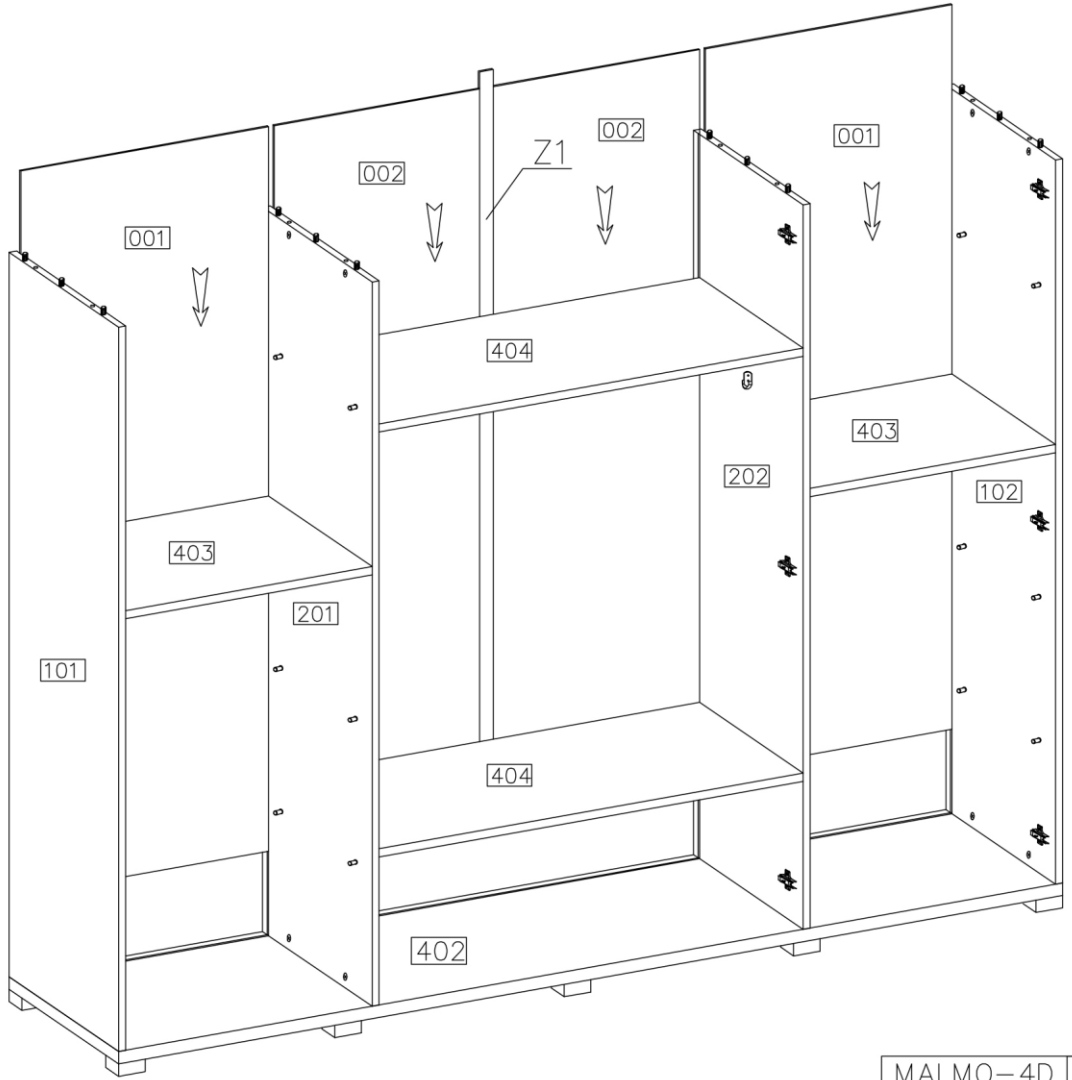
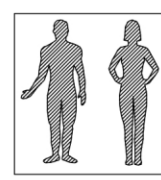
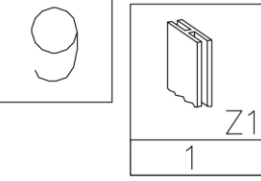
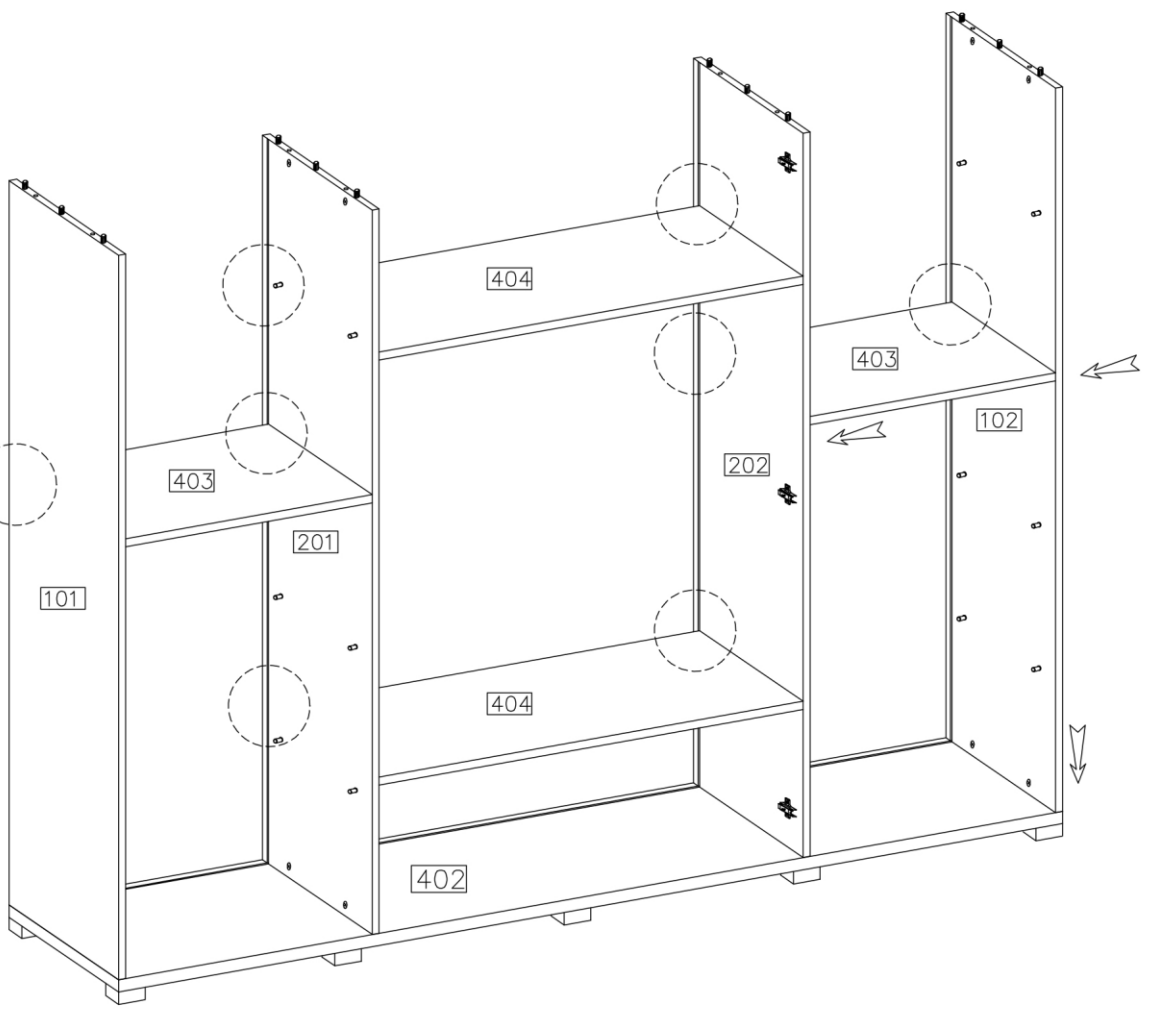
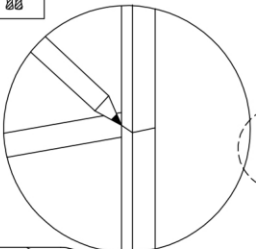
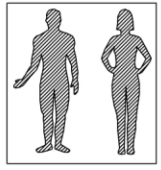
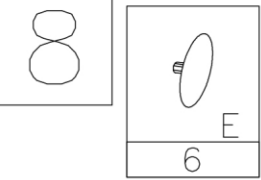

10

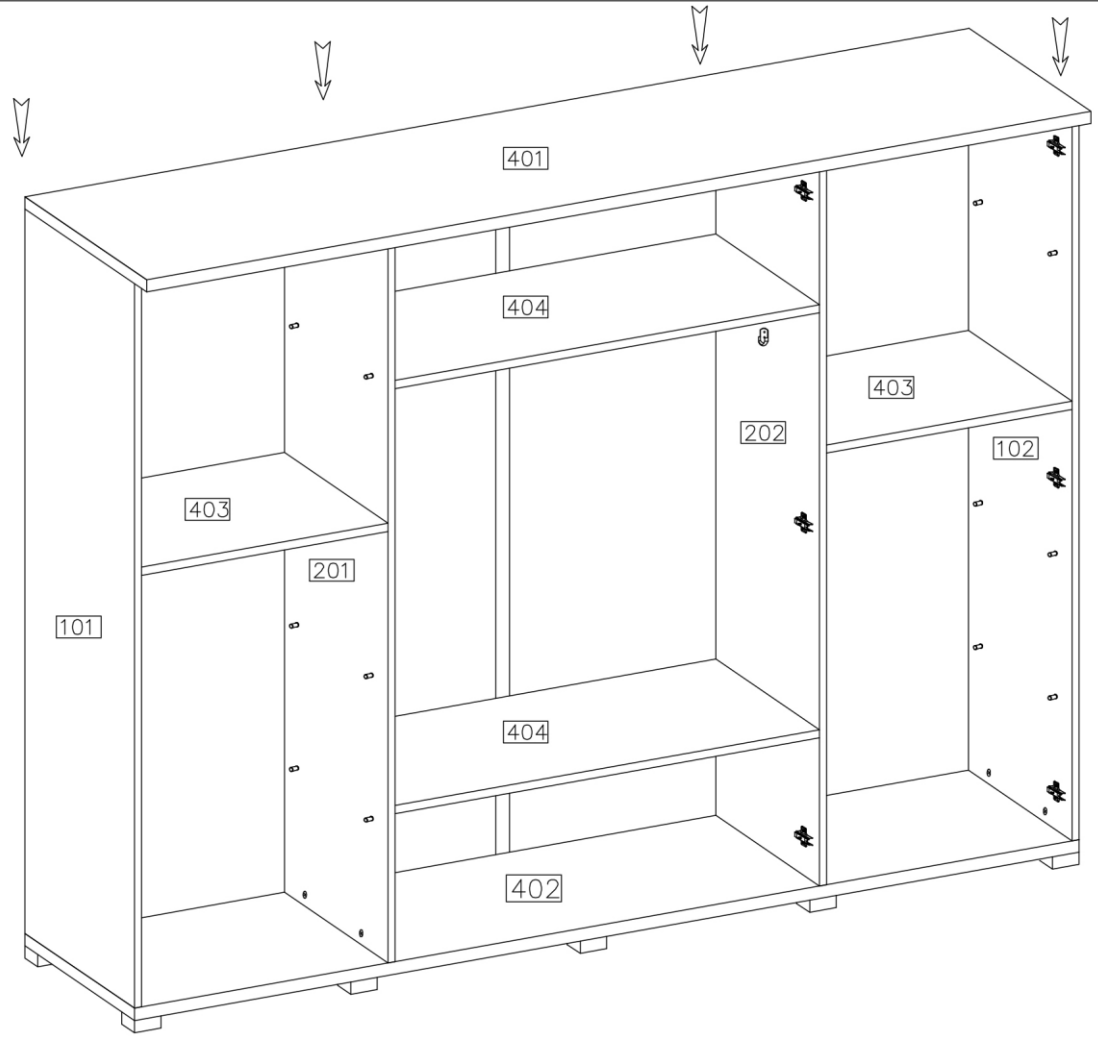
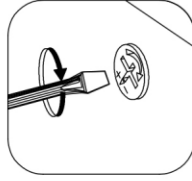
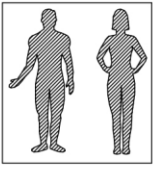
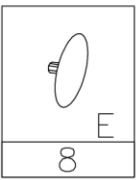

11

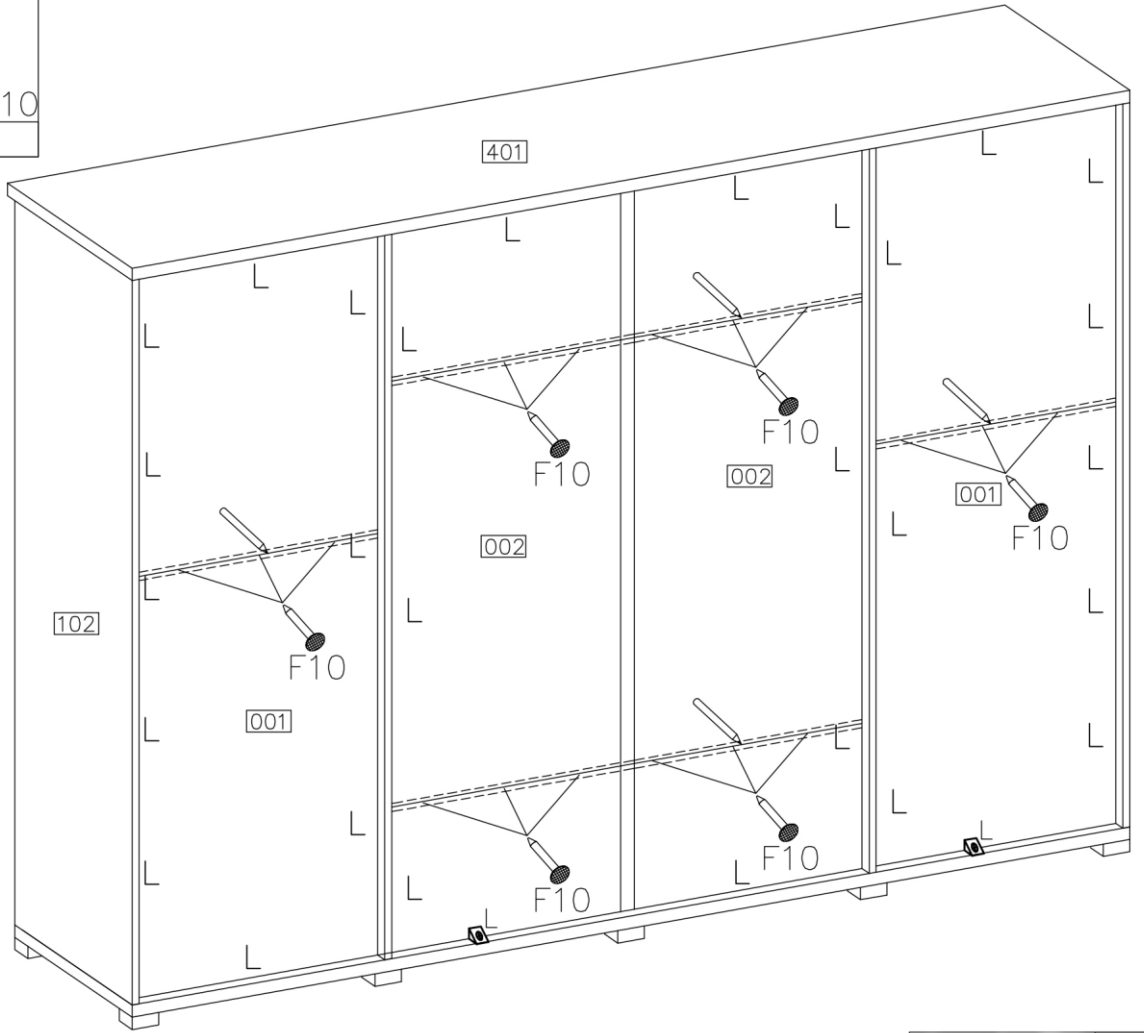
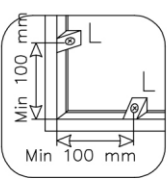
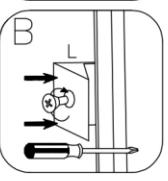
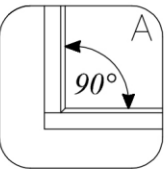
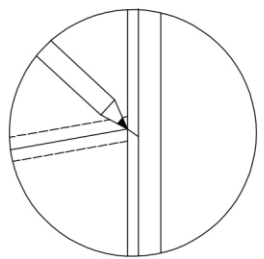
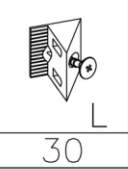

12

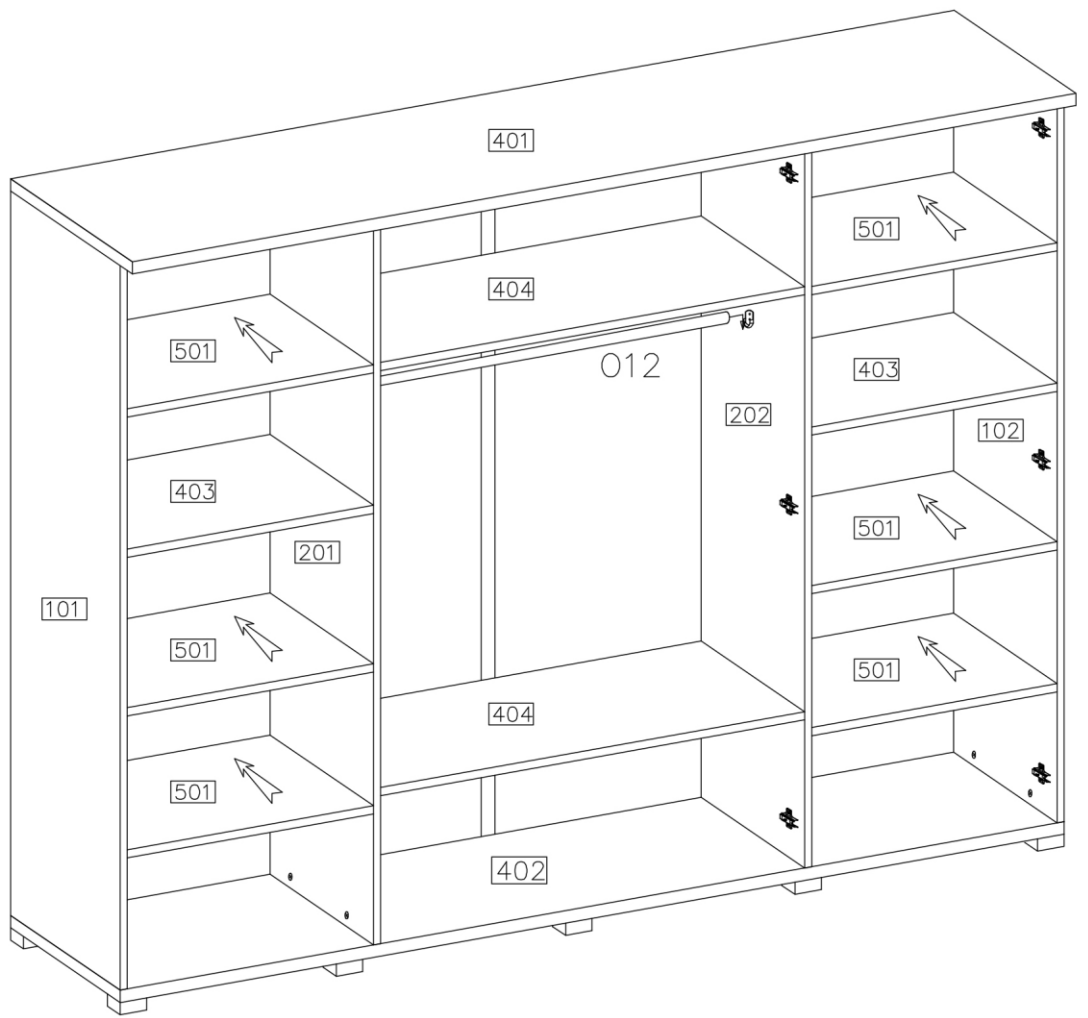
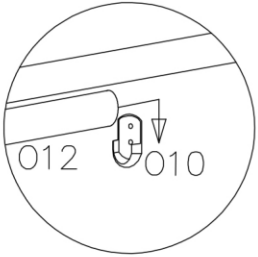
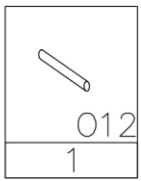



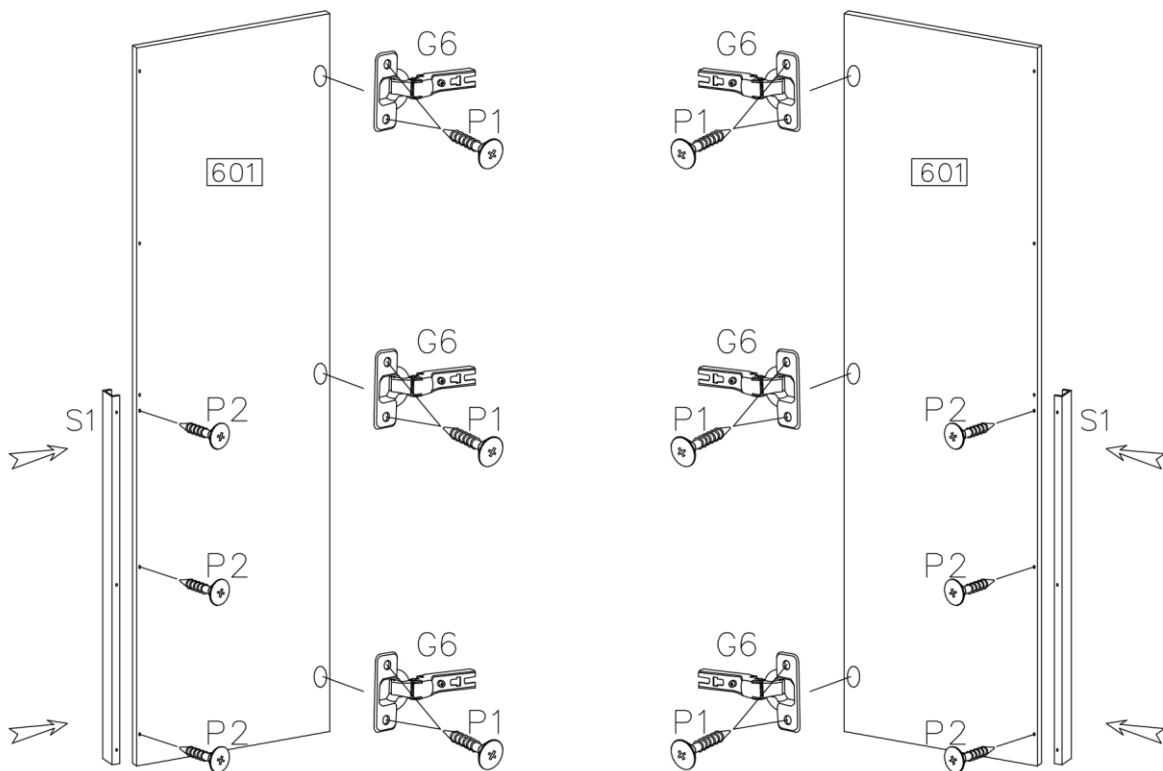
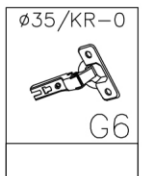
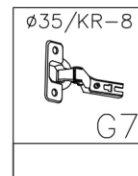

13

$\varnothing 35/KR-0$	$\varnothing 4.0 \times 16mm$	3.5x13mm	3.5x13mm
G6	P1	S1	P2
6	12	2	6



14

-  $\varnothing 35/KR-8$
G7
- 6
 $\varnothing 4.0 \times 16mm$
 P1
- 12
 S1
- 1
 $3.5 \times 13mm$
 P2
- 3

