

TEZRO NEW

Art.-Nr.

317 418
317 419
317 420

	1600
	938
	690
	mm

1/6
VO

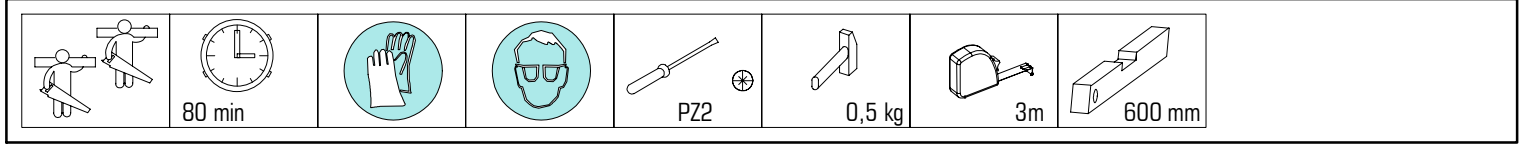

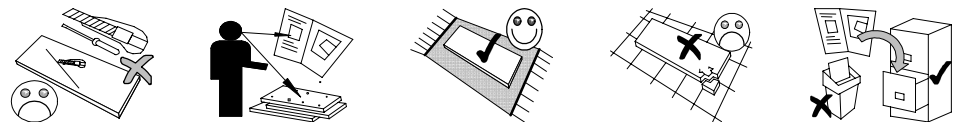
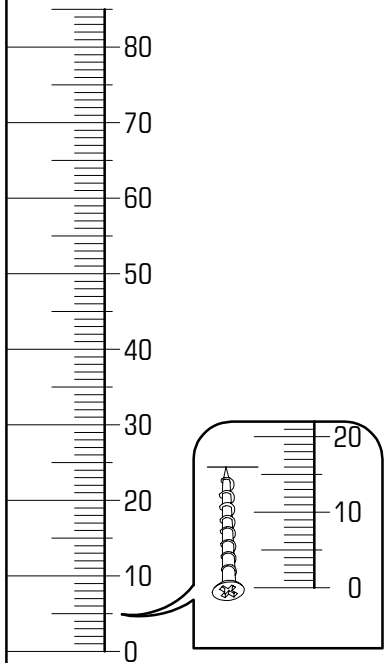
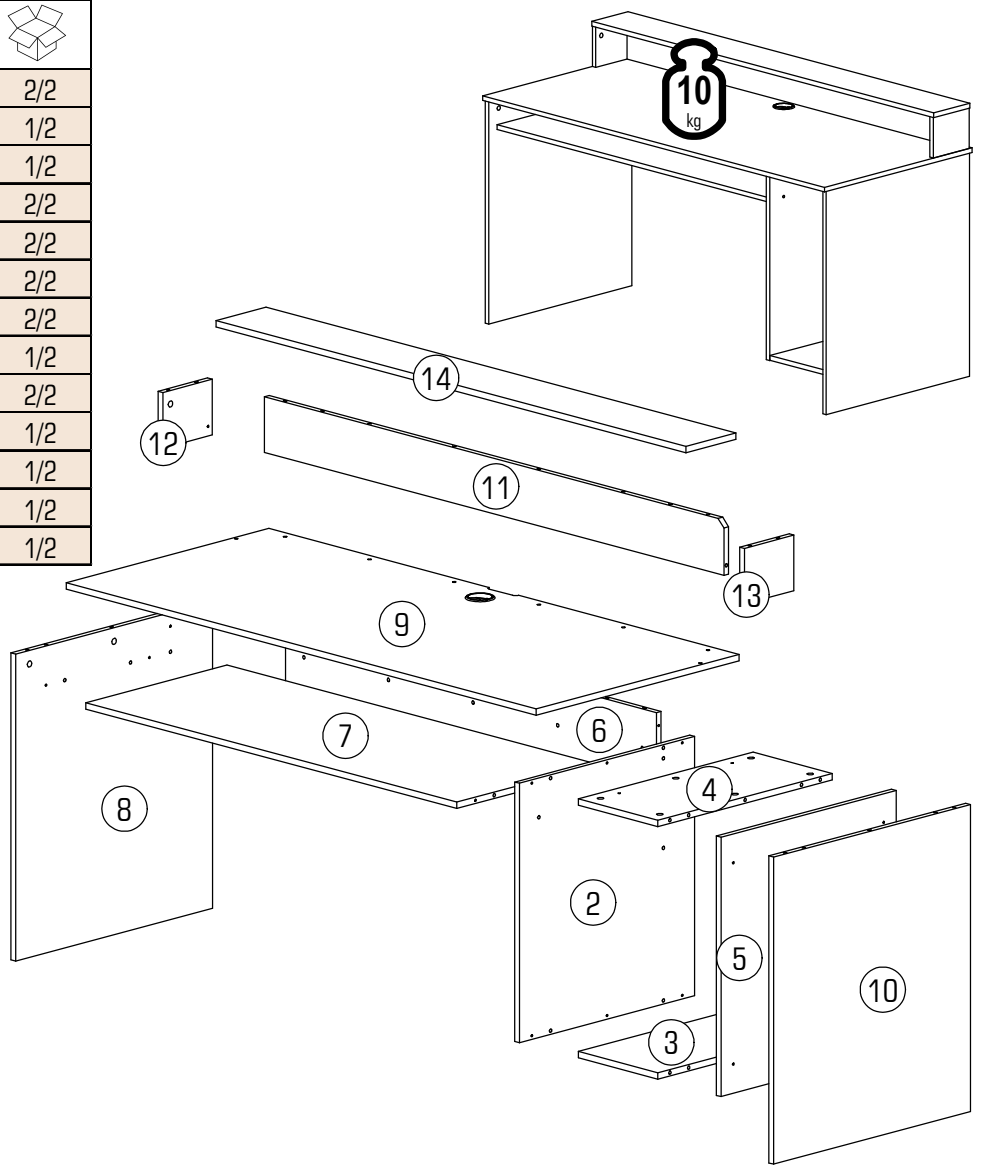

ID	ID	Image	Dimensions	Quantity	Weight
18830	②		648*596*16	1x	2/2
18831	③		270*594*16	1x	1/2
18852	④		270*594*16	1x	1/2
18832	⑤		648*596*16	1x	2/2
18833	⑥		1262*292*16	1x	2/2
18834	⑦		1262*480*16	1x	2/2
18835	⑧		767*670*16	1x	2/2
18836	⑨		1600*690*16	1x	1/2
18837	⑩		767*670*16	1x	2/2
18838	⑪		1564*139*16	1x	1/2
18839	⑫		139*168*16	1x	1/2
18840	⑬		139*168*16	1x	1/2
18841	⑭		1600*170*16	1x	1/2



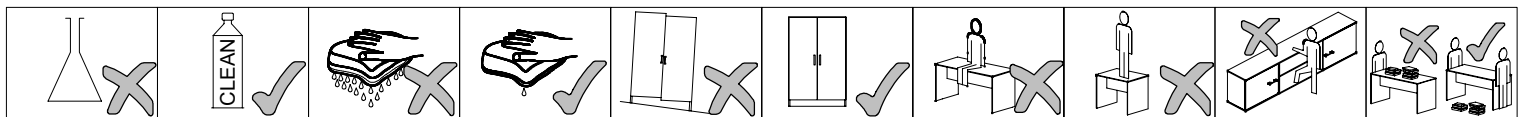

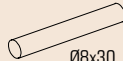
	22243,00		22280,00		22300,00		22800,01		27000,00		30097,00		70013,01		70021,01
A	4x	B	6x	C	15x	D	1x	E	28x	F	4x	G	37x	H	37x
	35209,01		60025,05		35209,01		35209,01		60025,05		60025,05		60025,05		60025,05
J	4x	K	2x	L	4x	M	1x	N	1x	O	1x	P	1x	Q	1x

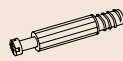

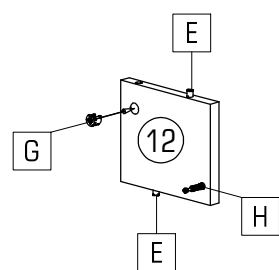
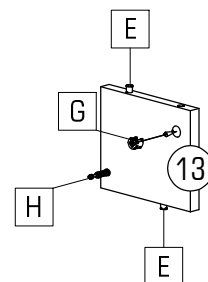
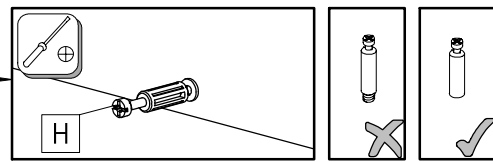
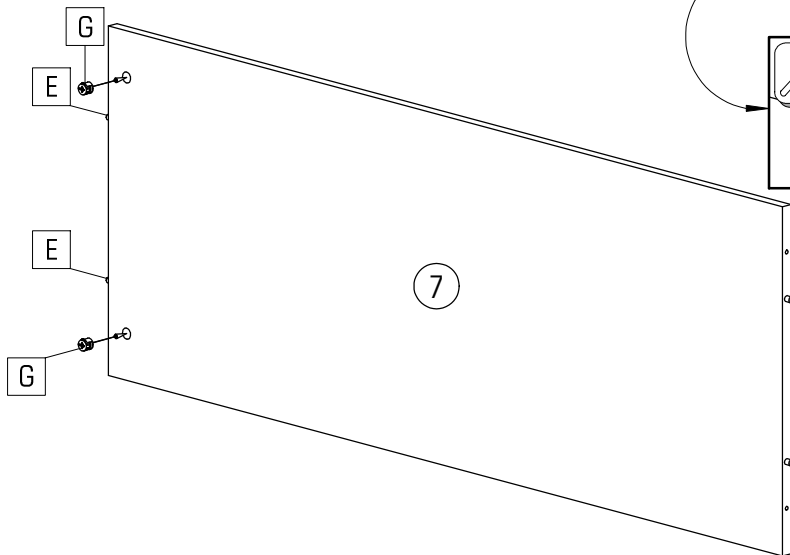
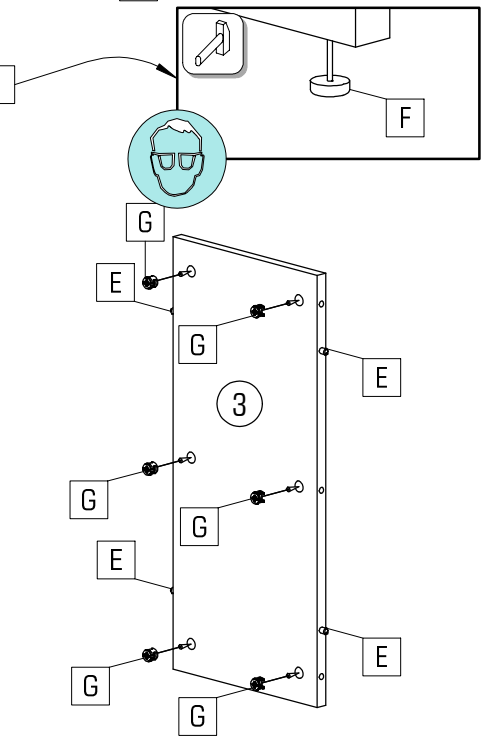
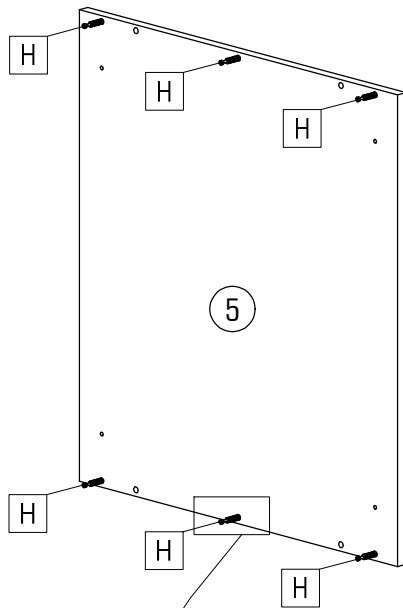
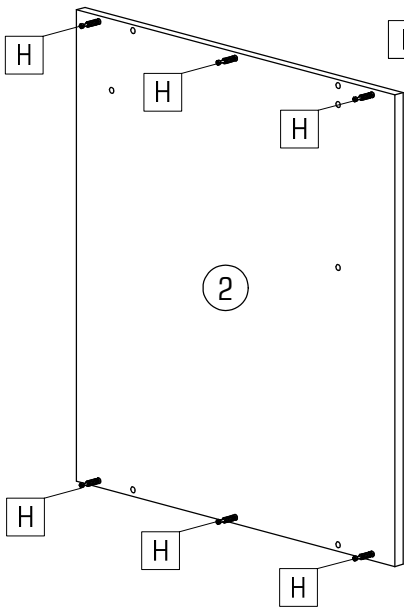
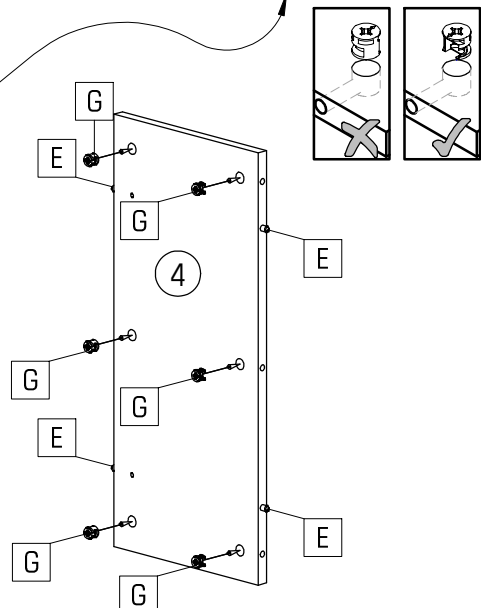
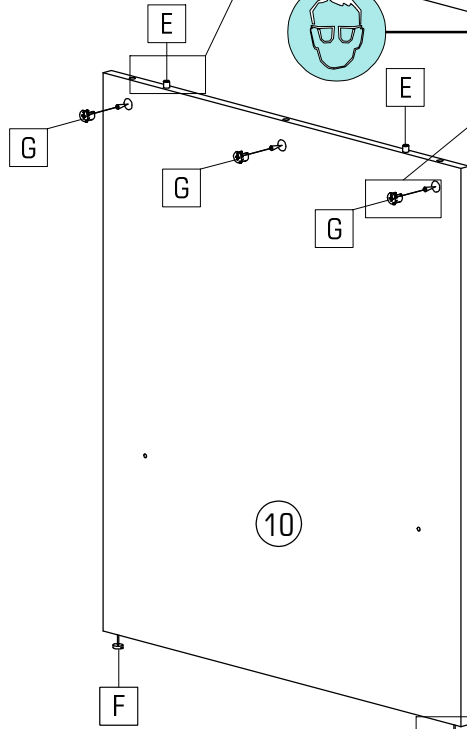
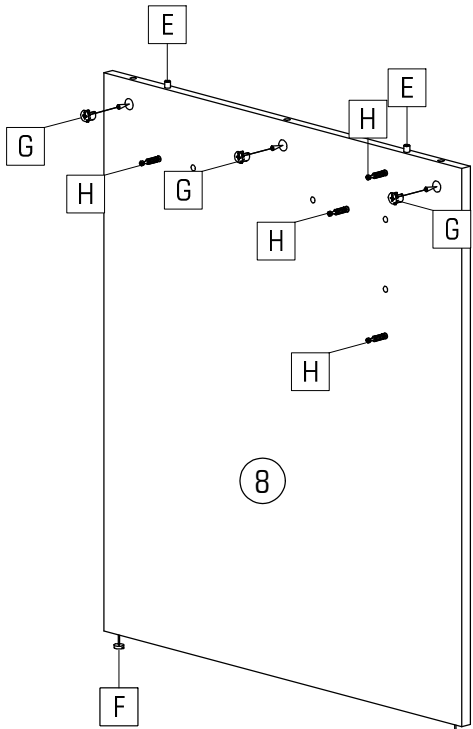
			
E 20x	F 4x	G 22x	H 18x

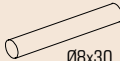

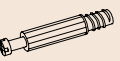

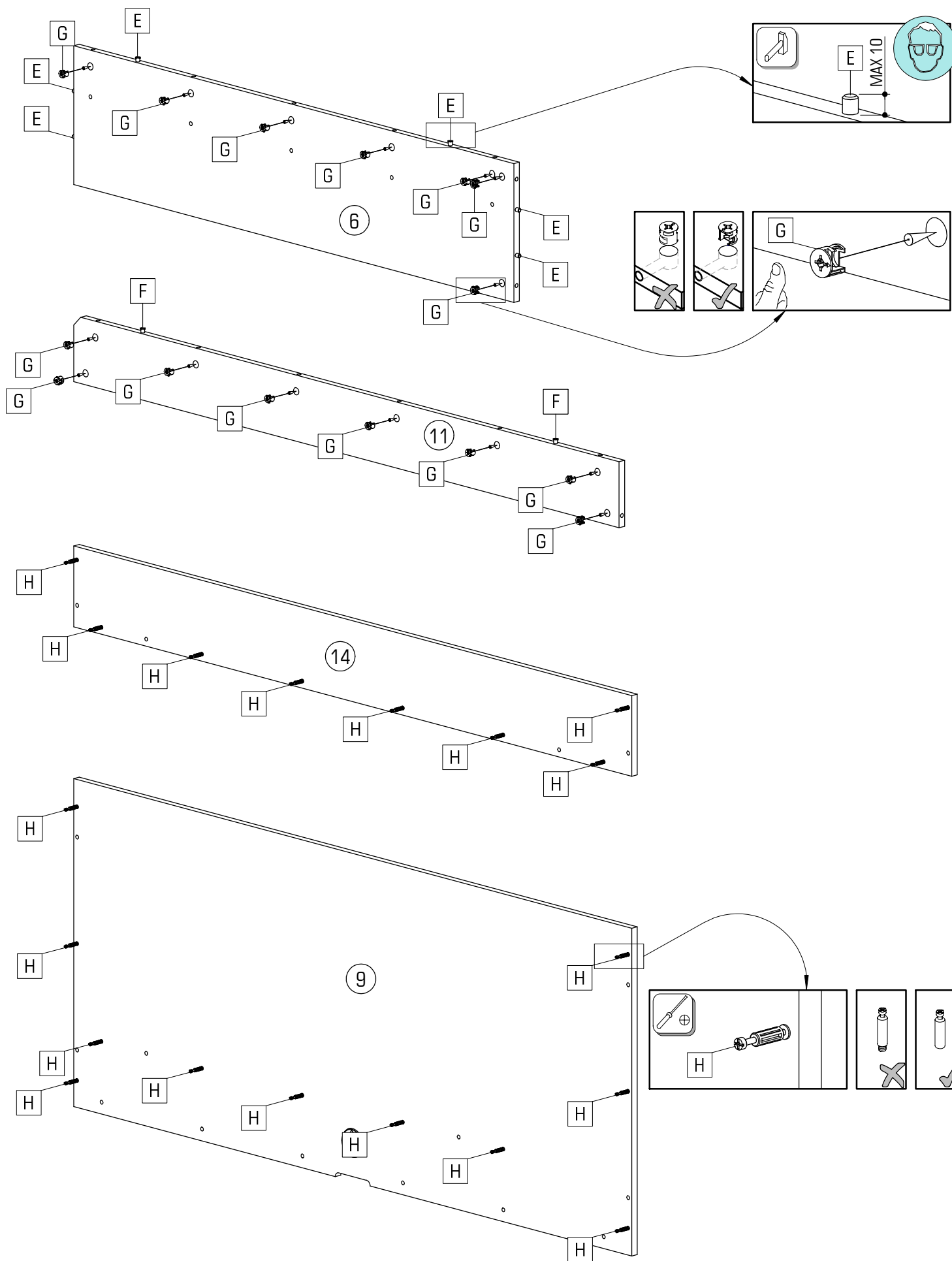
	$\varnothing 8 \times 30$		$\varnothing 15 \times 13$		
E	8x	G	15x	H	19x





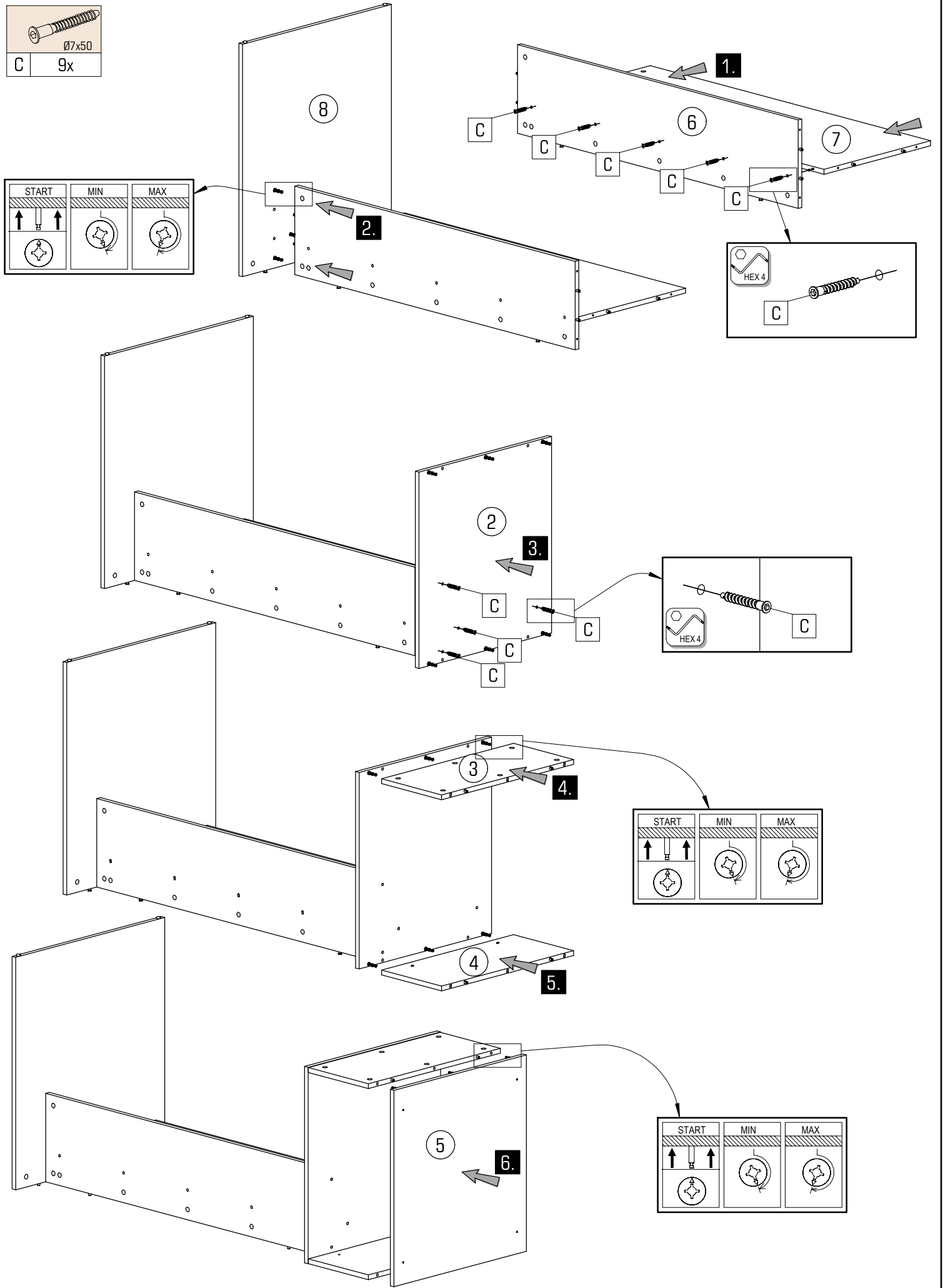
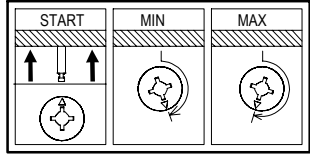

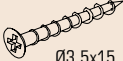

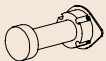

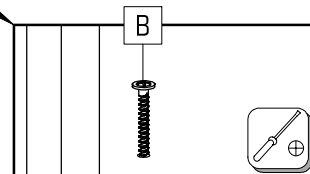
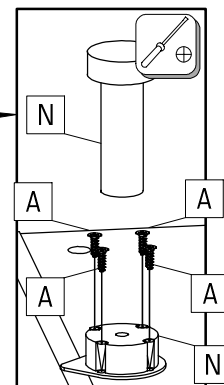
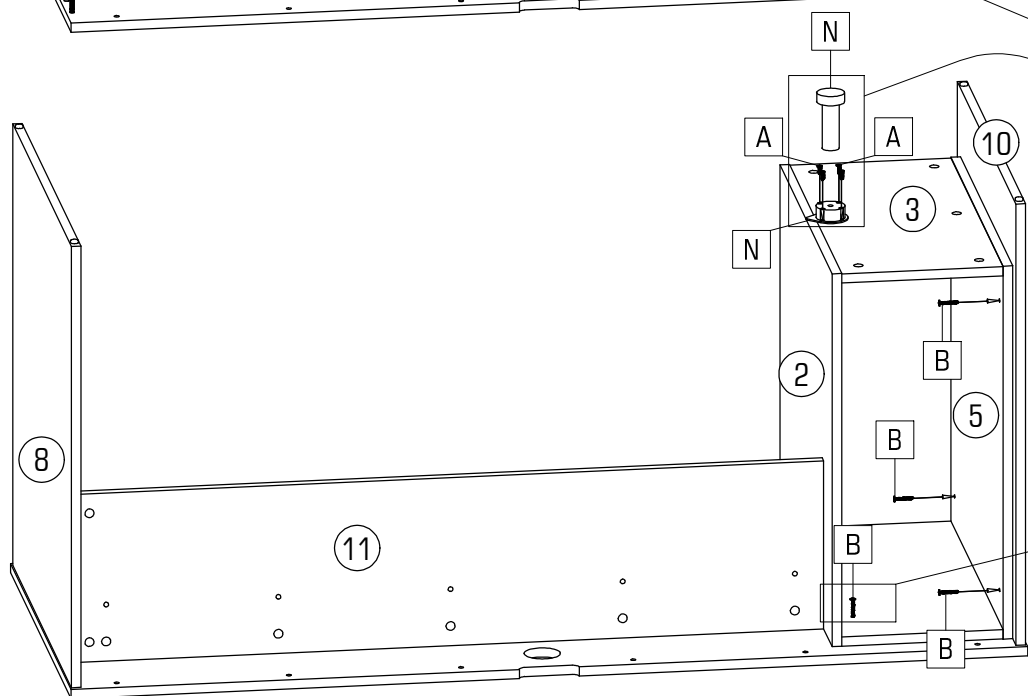
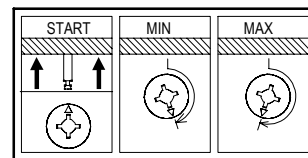
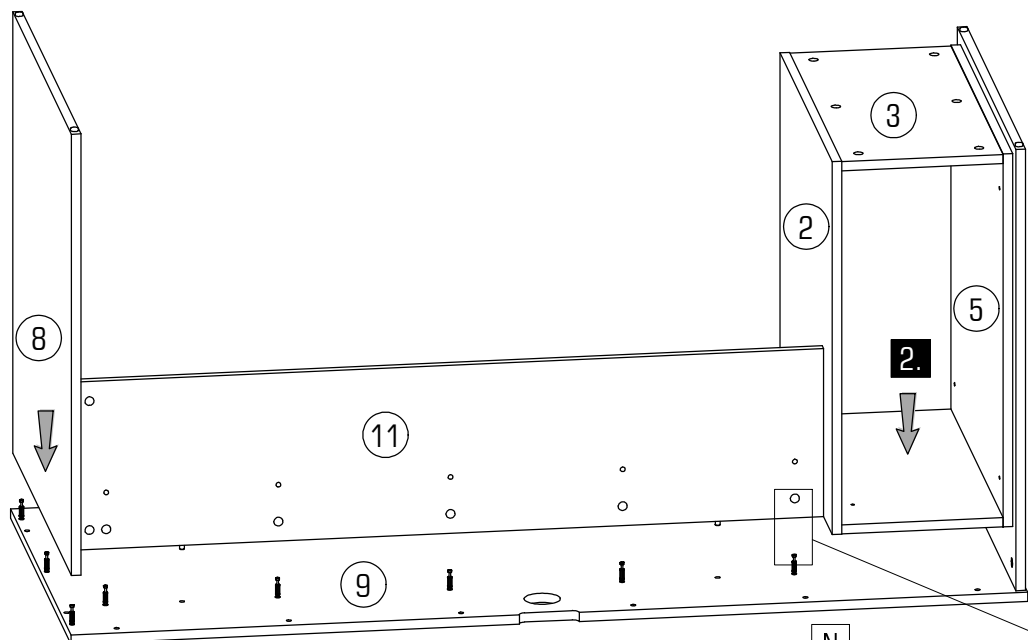
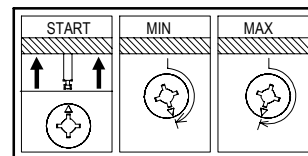
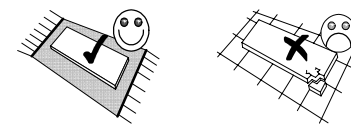
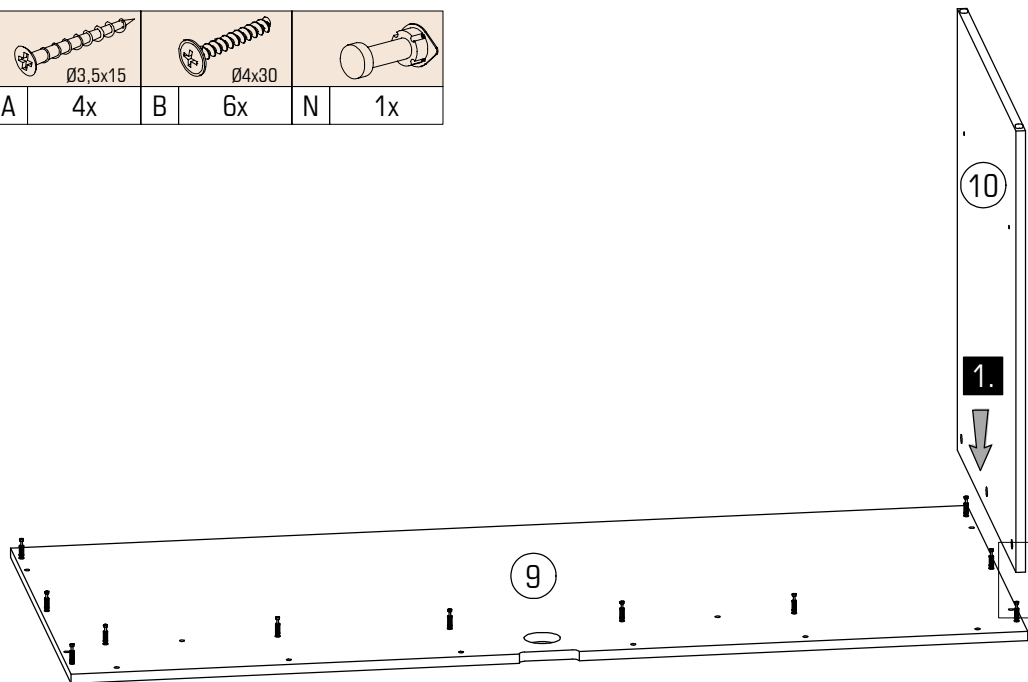
C 9x



	$\varnothing 3,5 \times 15$		$\varnothing 4 \times 30$		
A	4x	B	6x	N	1x



				
Ø7x50				Ø60
C 6x	J 4x	K 2x	L 4x	M 1x

