

# Anteroom

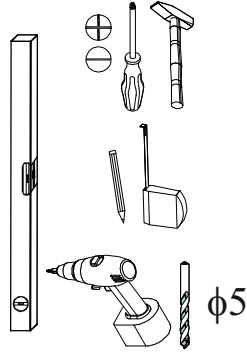

number	Measurements	Pcs.
1	415x349	1
2	415x350	1
3	535x330	1
4	535x60	1
5	899x350	1
6	588x350	1
7	1960x590	1
8	1860x350	1
9	300x120	1
10	300x120	1
11	479x120	1
12	529x220	1
13	489x296	1
14	1858x348	1

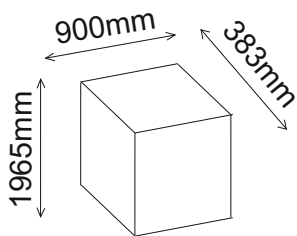
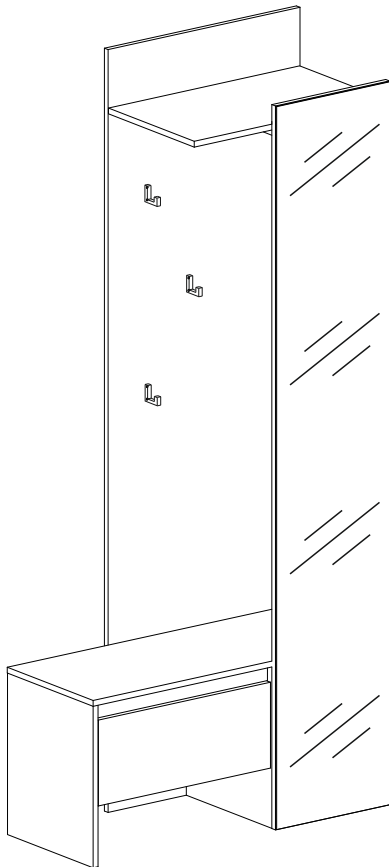
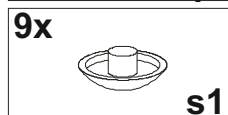
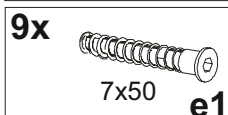
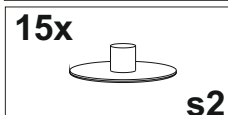
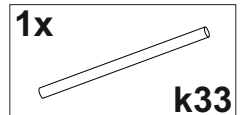
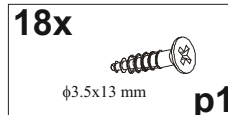
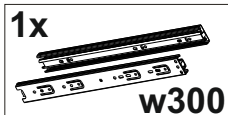
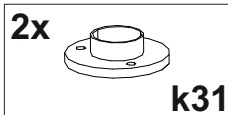
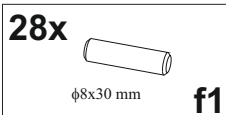
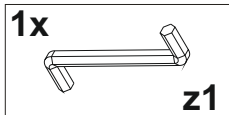
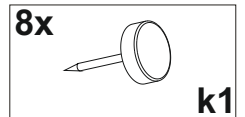
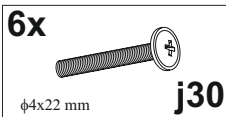
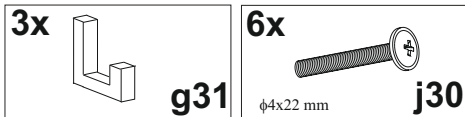
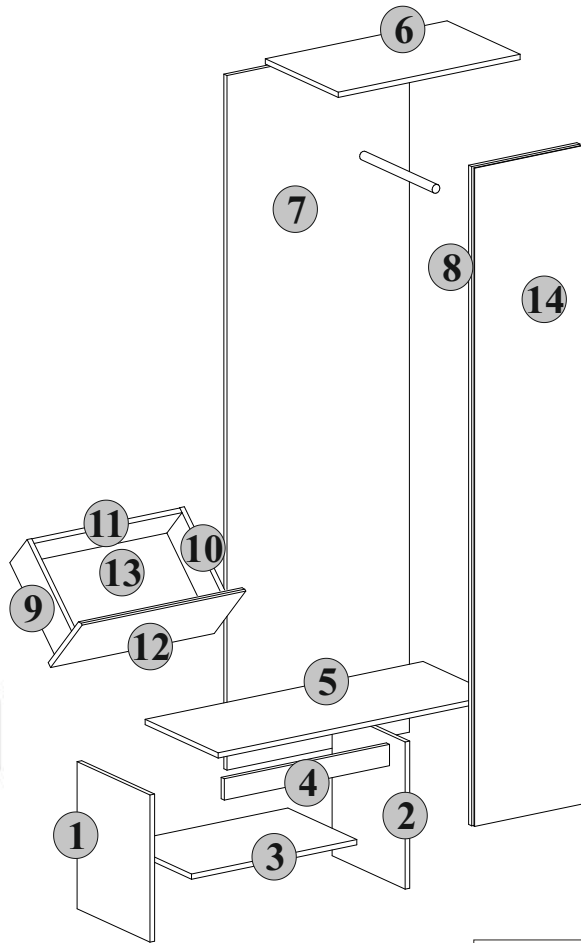

# I

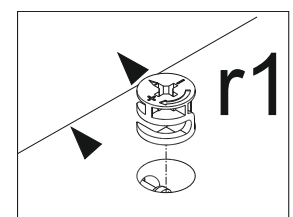
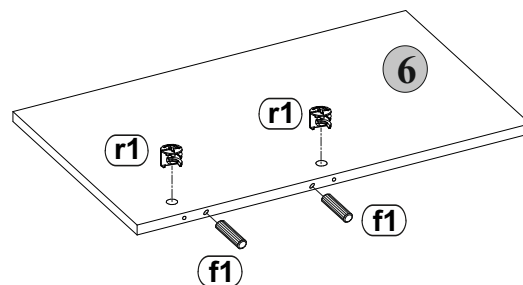
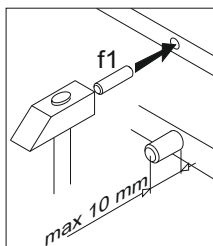
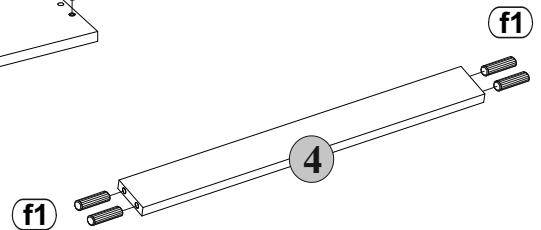
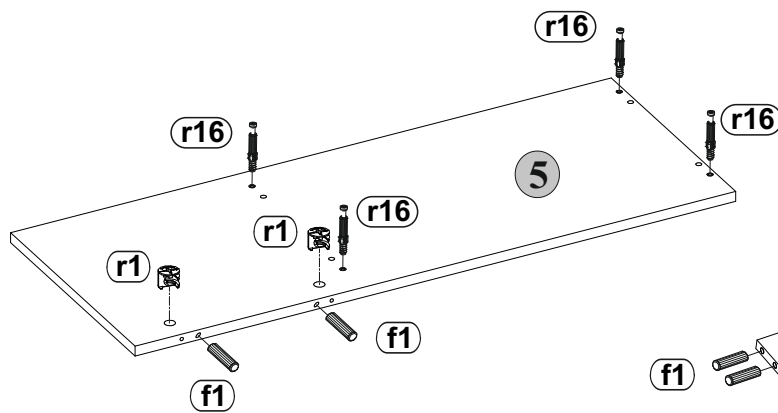
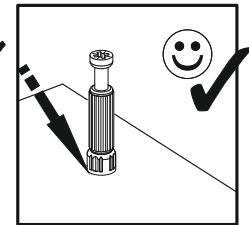
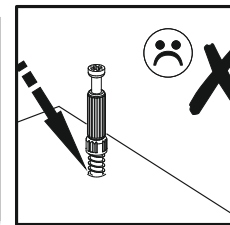
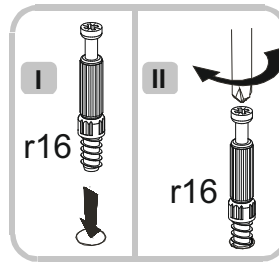
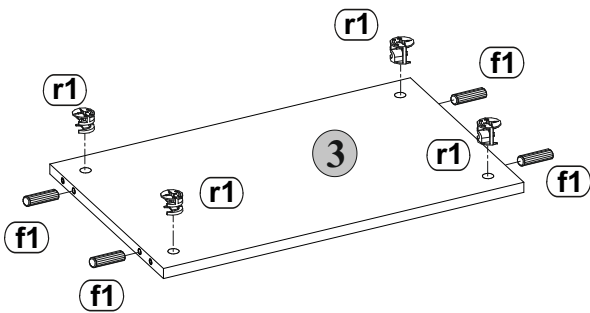
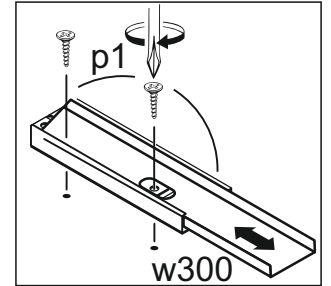
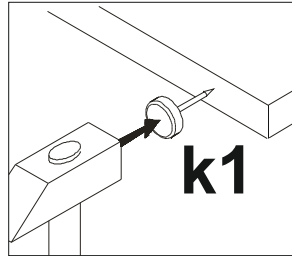
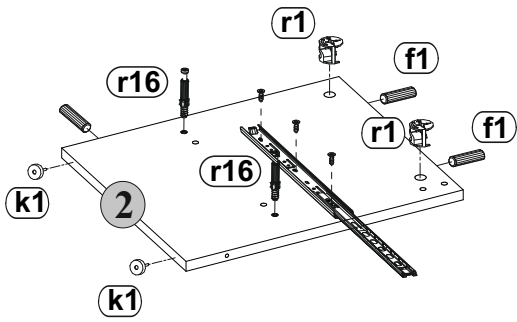
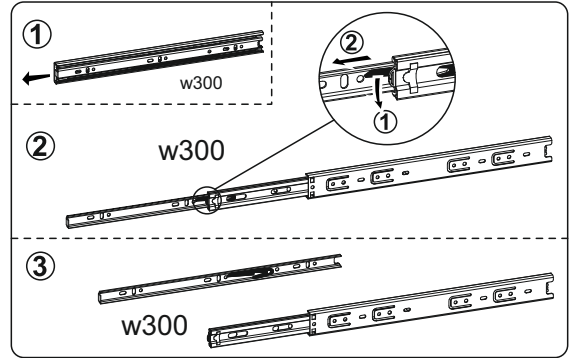
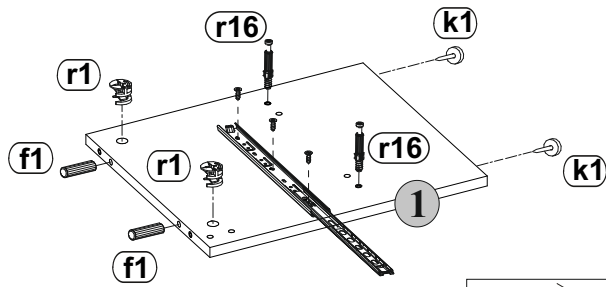

**2**

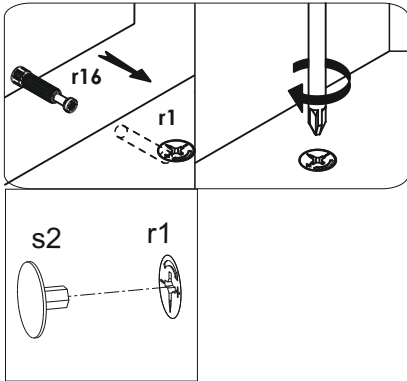
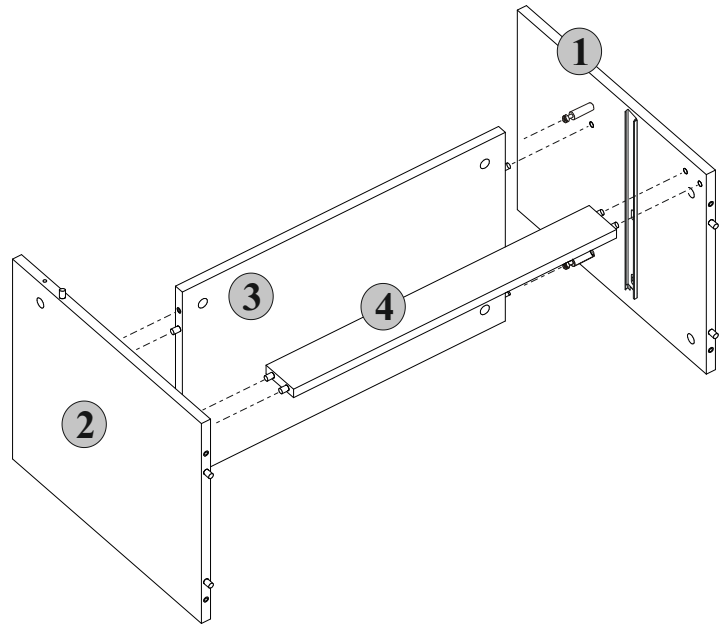

**3**

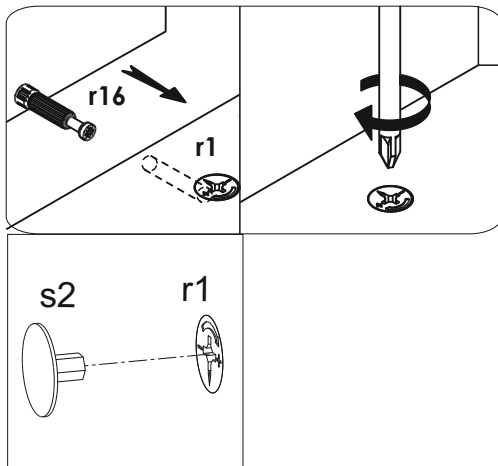
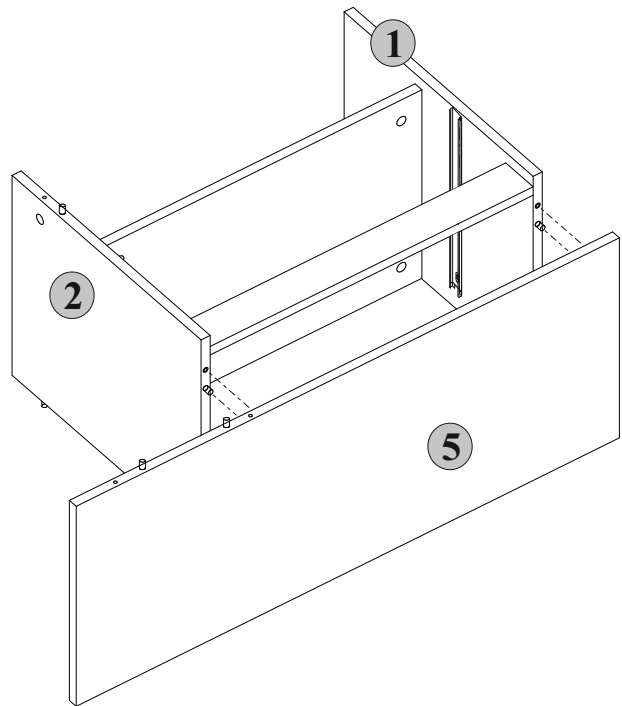

**3**

4

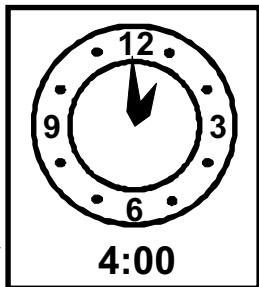
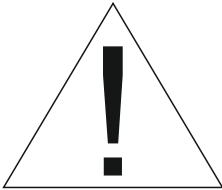
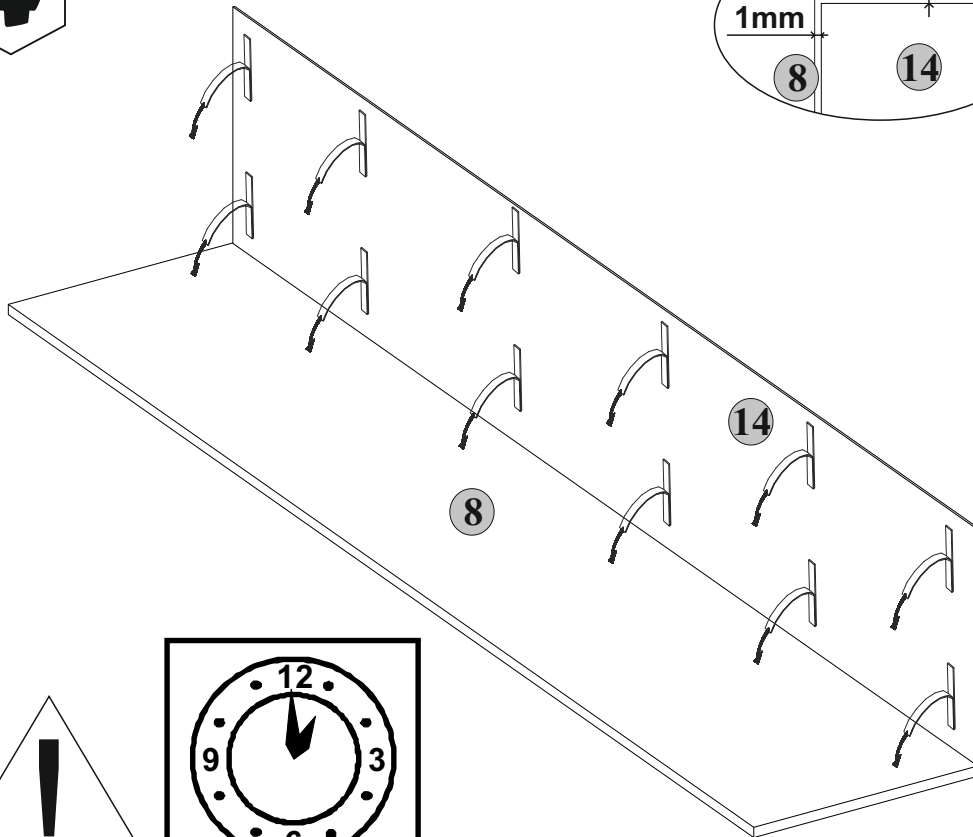
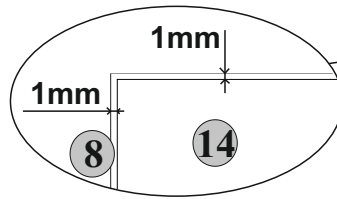

5

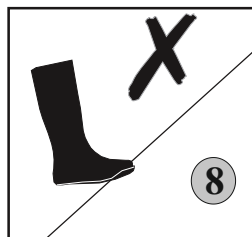
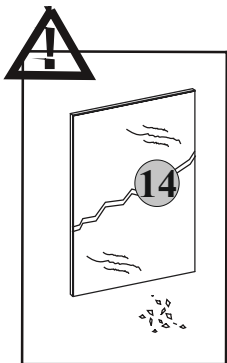
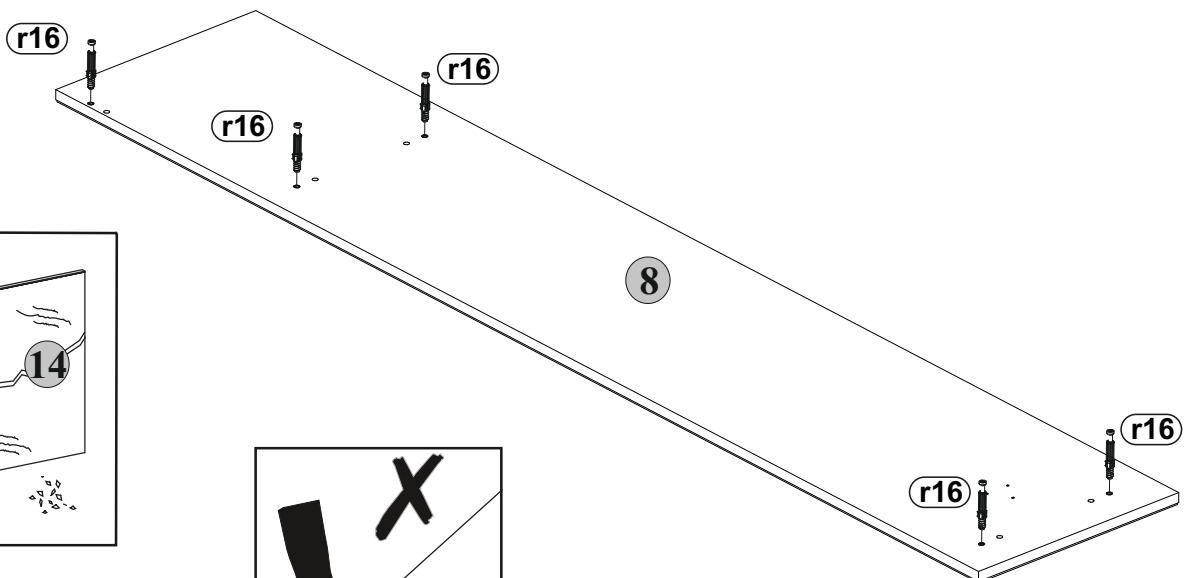
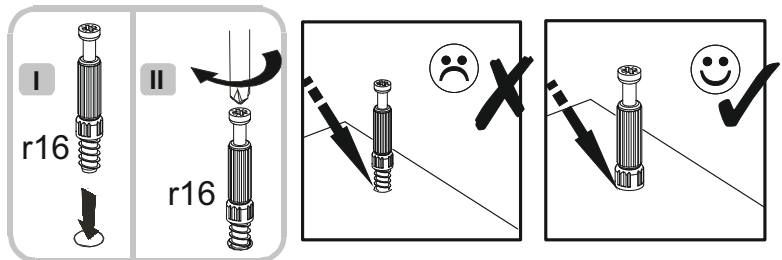

4

6

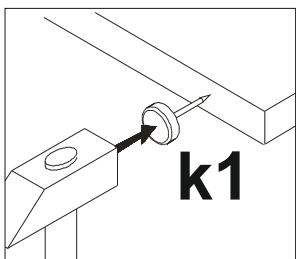
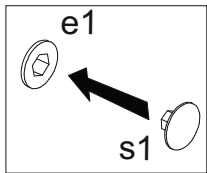
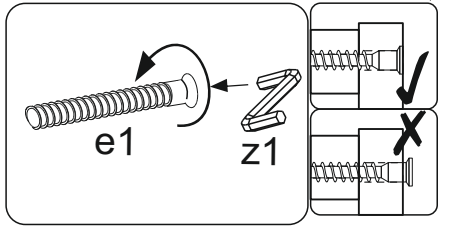
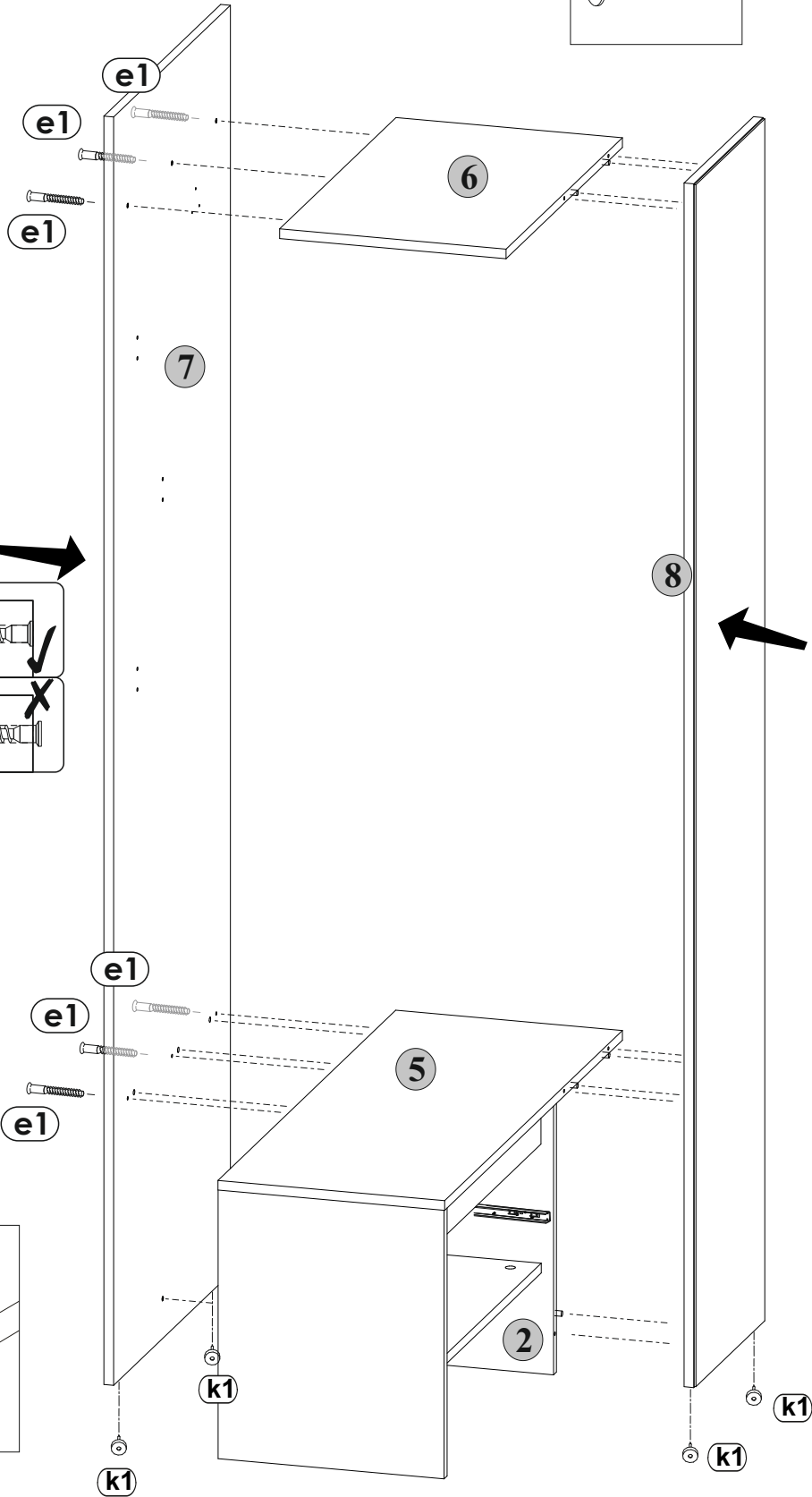
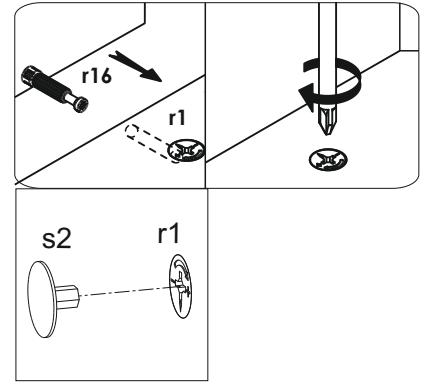

5

7

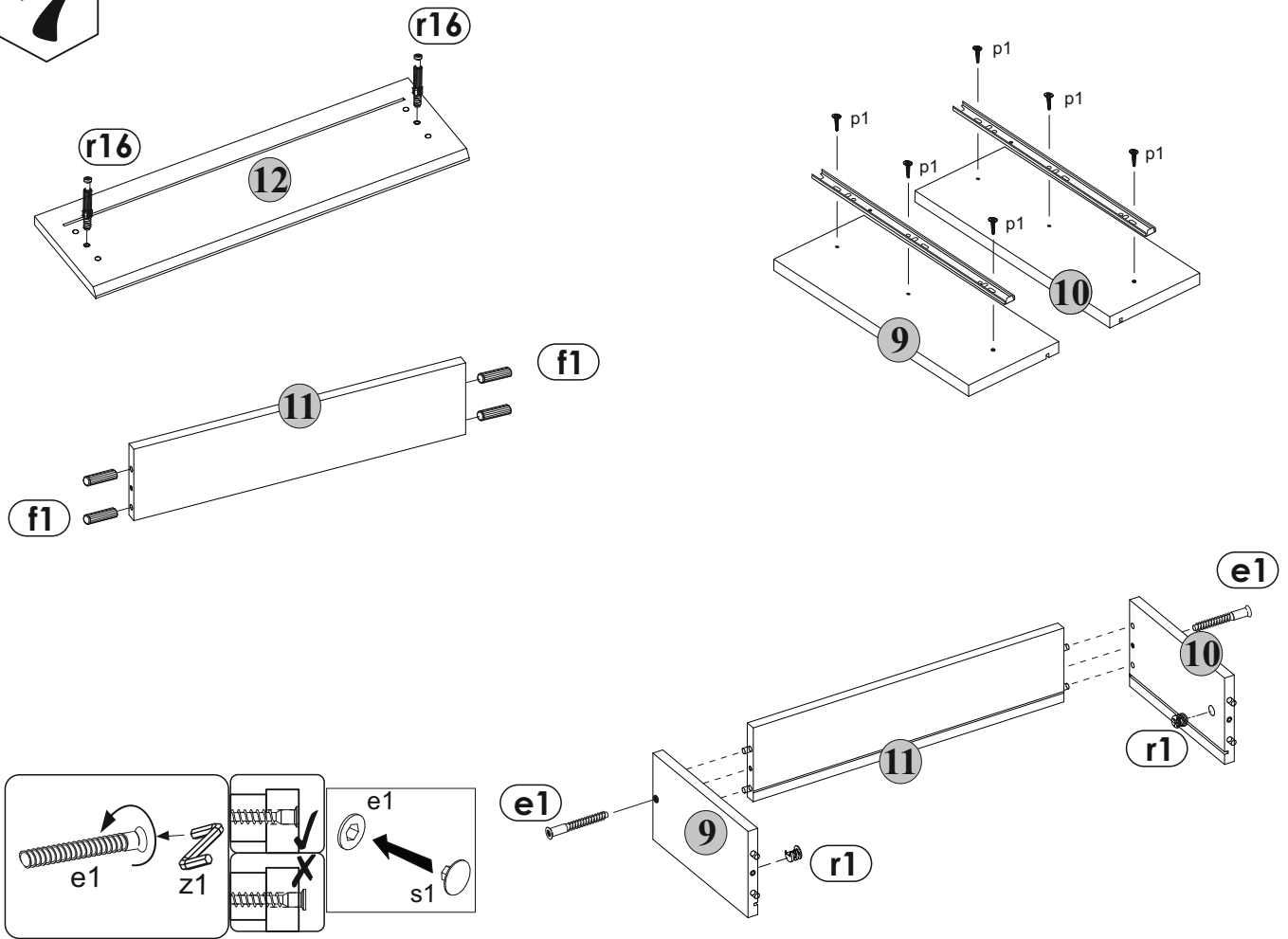

8

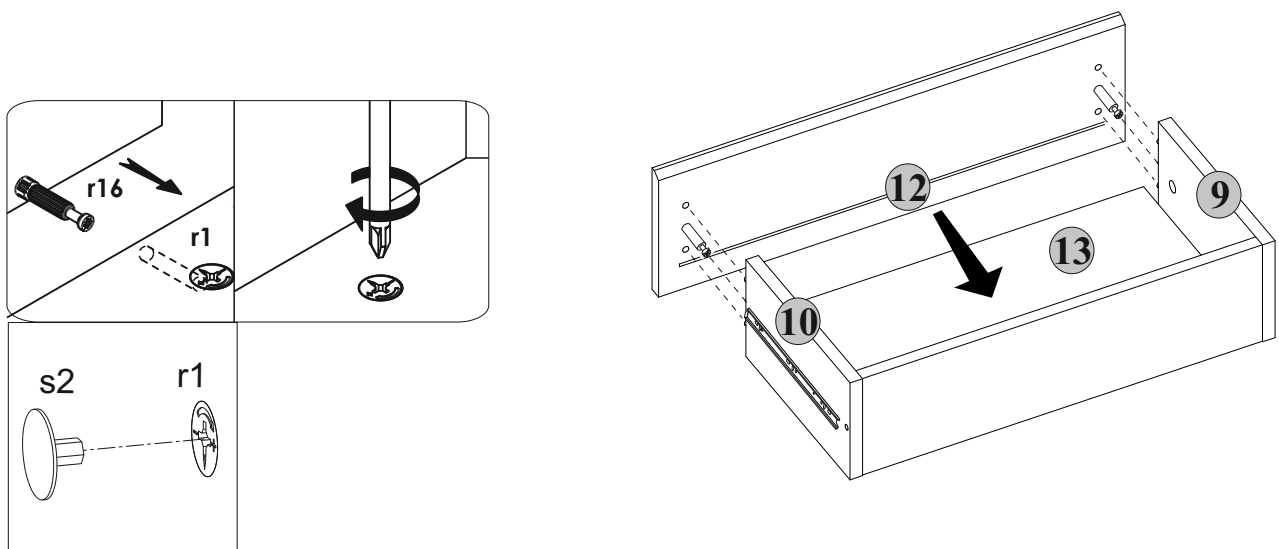

6

9

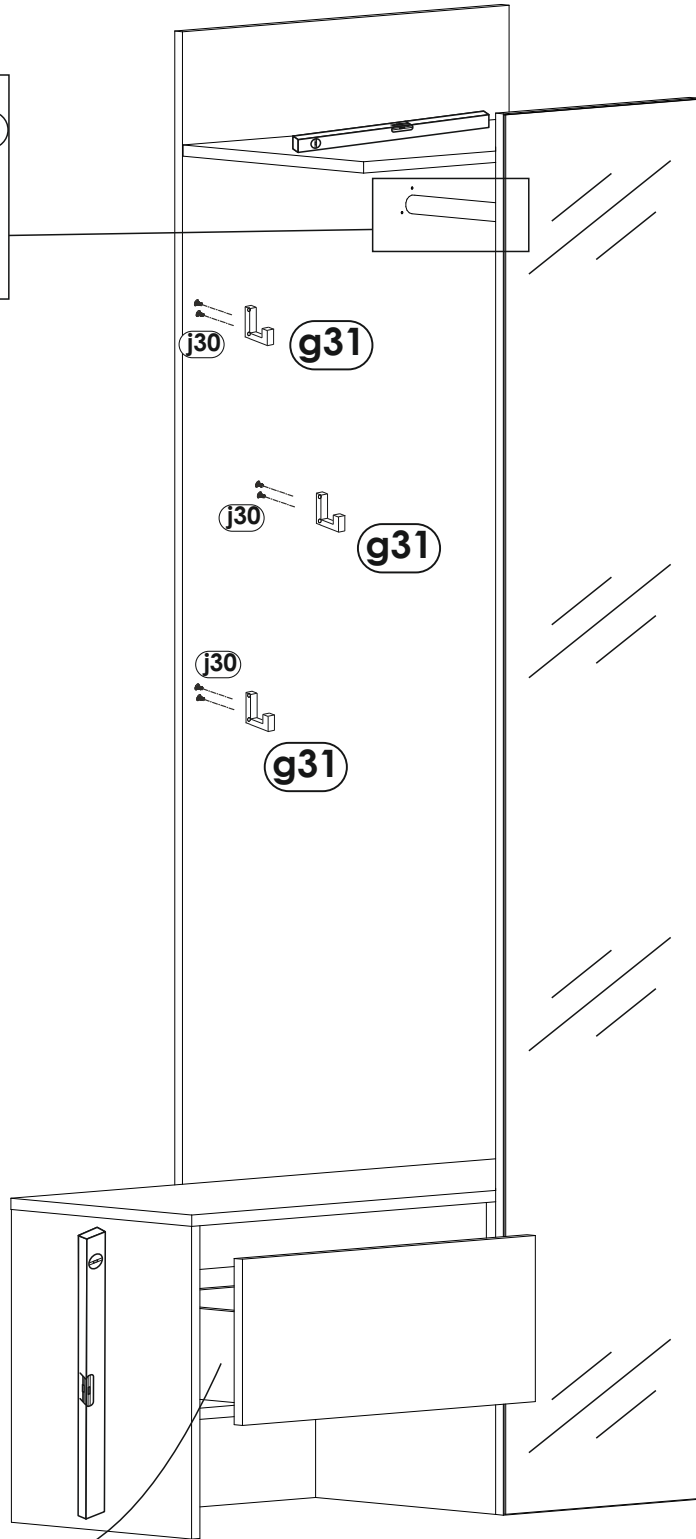
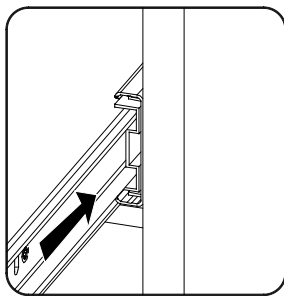
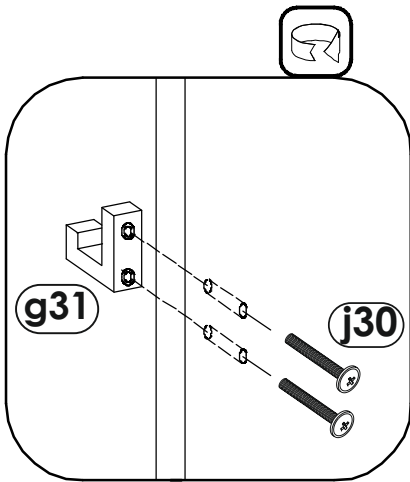
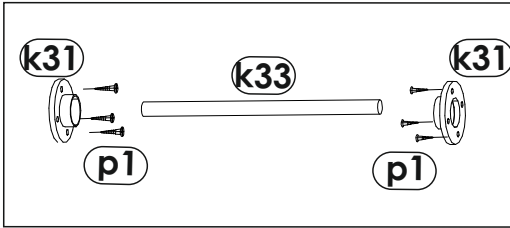
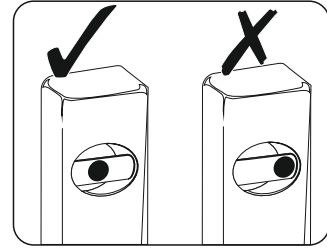

7