

DELIMA

	1200	1/6
	745	
	450	
		mm

ID	ID			
15622	②	723*446*22	1x	2/2
15623	③	1150*228*22	1x	2/2
15624	④	723*446*22	1x	2/2
15625	⑤	1200*450*22	1x	2/2
15626	⑥	350*322*22	1x	2/2
15627	⑦	954*352*22	1x	1/2
15628	⑧	466*320*16	2x	1/2
15629	⑨	400*356*22	1x	1/2
15630	⑩	400*356*22	1x	1/2
15631	⑪	466*229*16	2x	1/2
15632	⑫	1000*360*22	1x	1/2





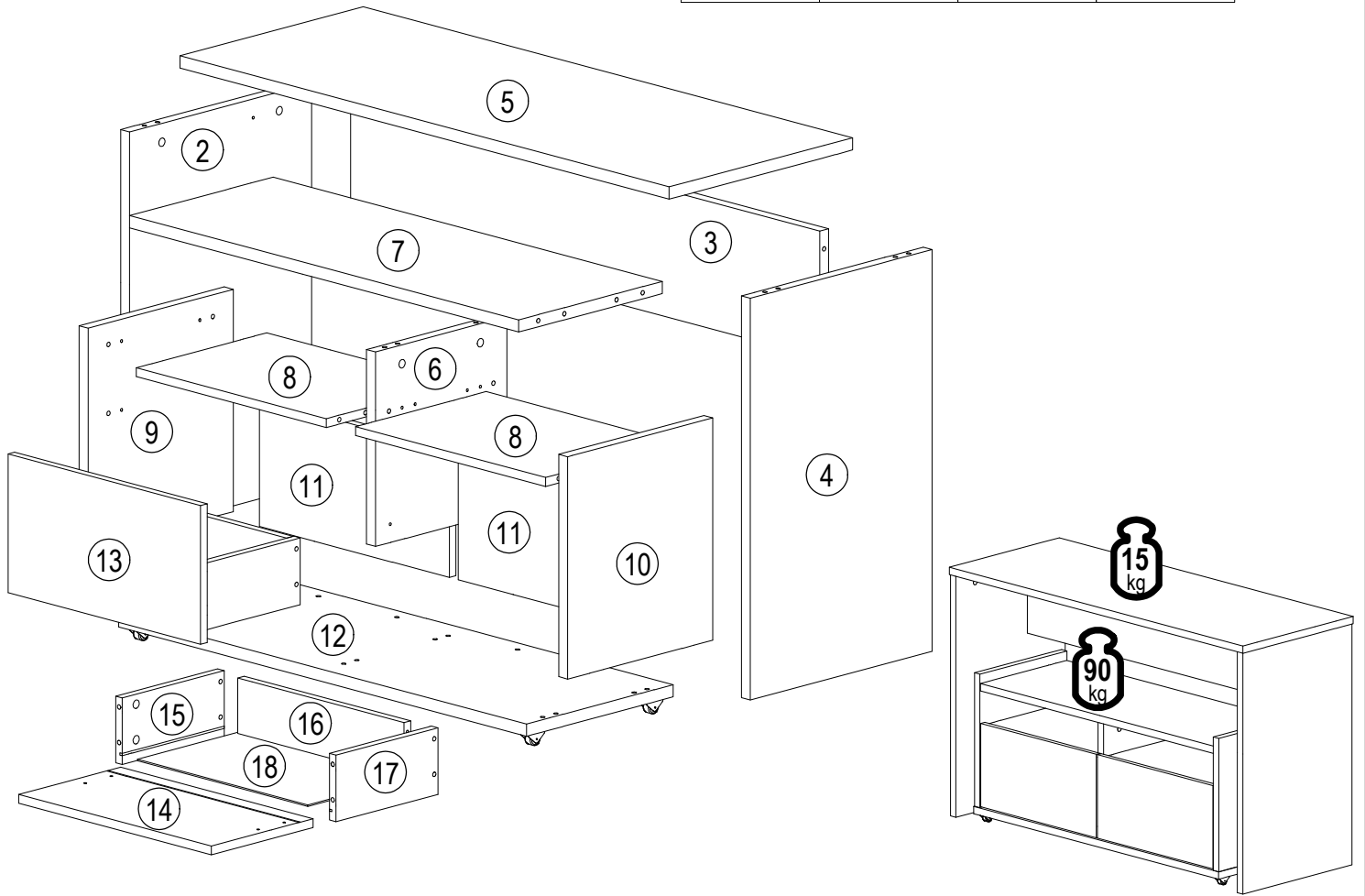

ID	ID			
15633	⑬	472*250*16	1x	1/2
15634	⑭	472*250*16	1x	1/2
15635	⑮	250*120*16	2x	1/2
15636	⑯	408*100*16	2x	1/2
15637	⑰	250*120*16	2x	1/2
15638	⑱	256*418*2,5	2x	1/2

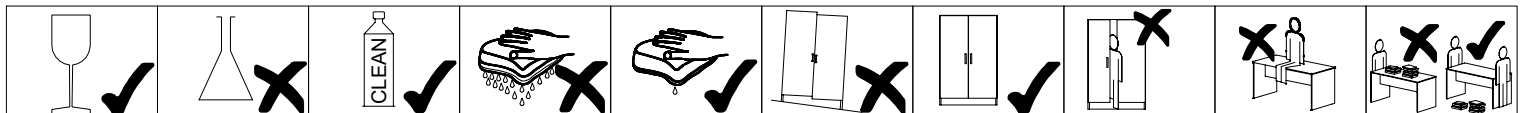
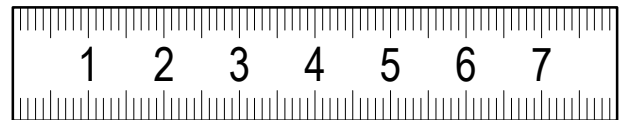
 45 min		 3m	
 ≤ 0,5 kg	 PZ 2	 600 mm	 4

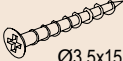
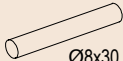



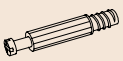

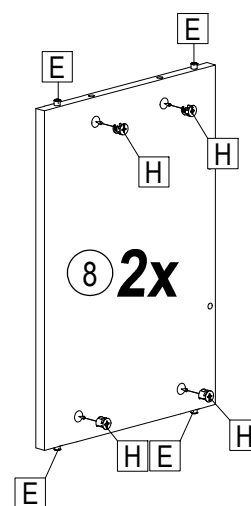
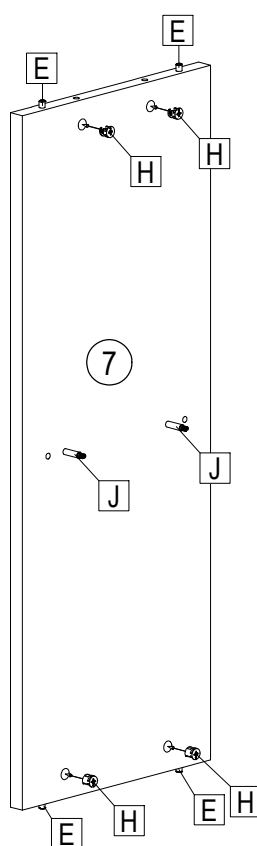
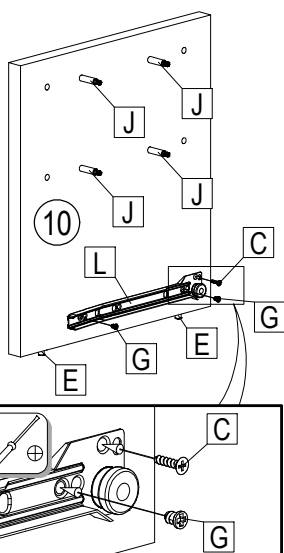
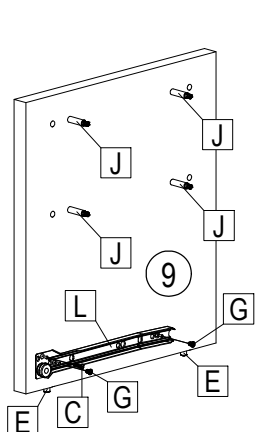
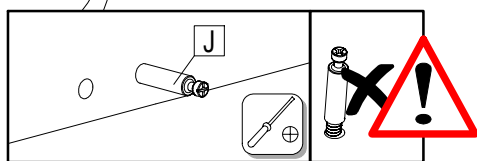
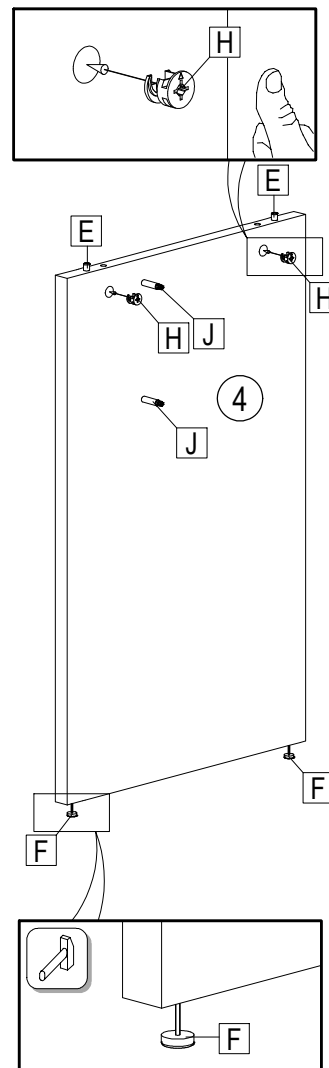
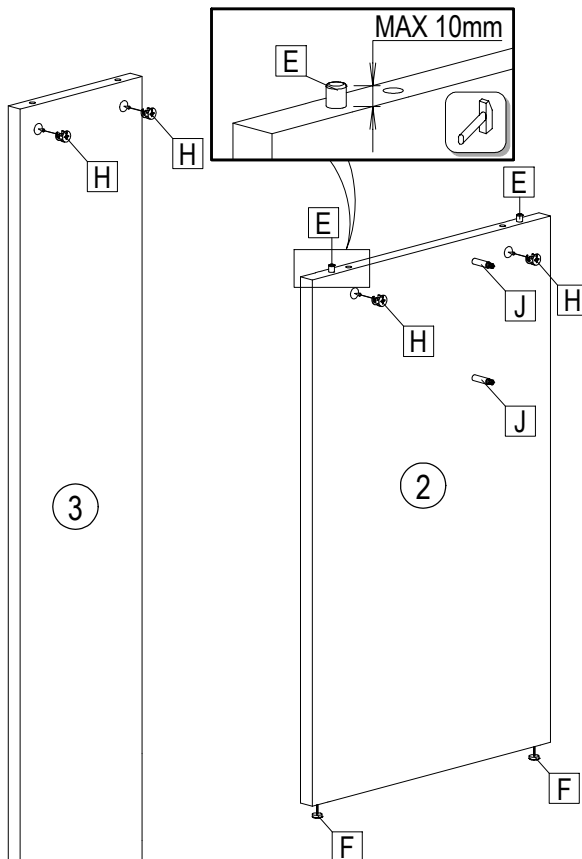
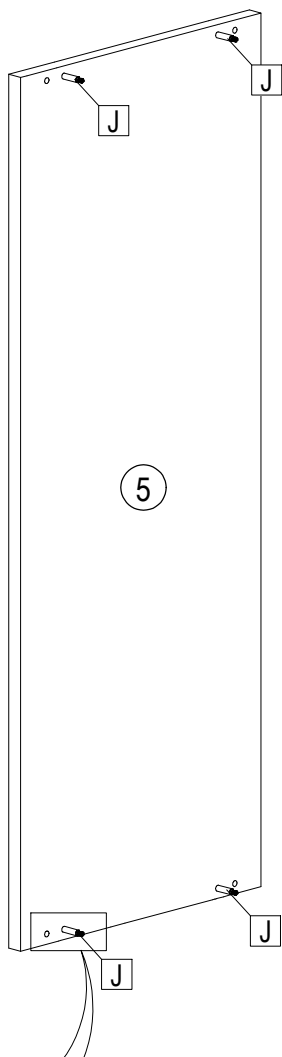

22244.01 Ø3,5x16	50553.00 	22243.00 Ø3,5x15	22300.00 Ø7x50	27000.00 Ø8x30	30091.00 F	22705.00 Ø6,3x8	70013.01 Ø15x13	70021.01 	
A 18x	B 4x	C 12x	D 14x	E 32x	F 4x	G 8x	H 30x	J 30x	K 8x
33005.00 L=250mm		30130.00 							
L 2x	M 14x	N 5x							





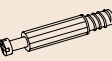

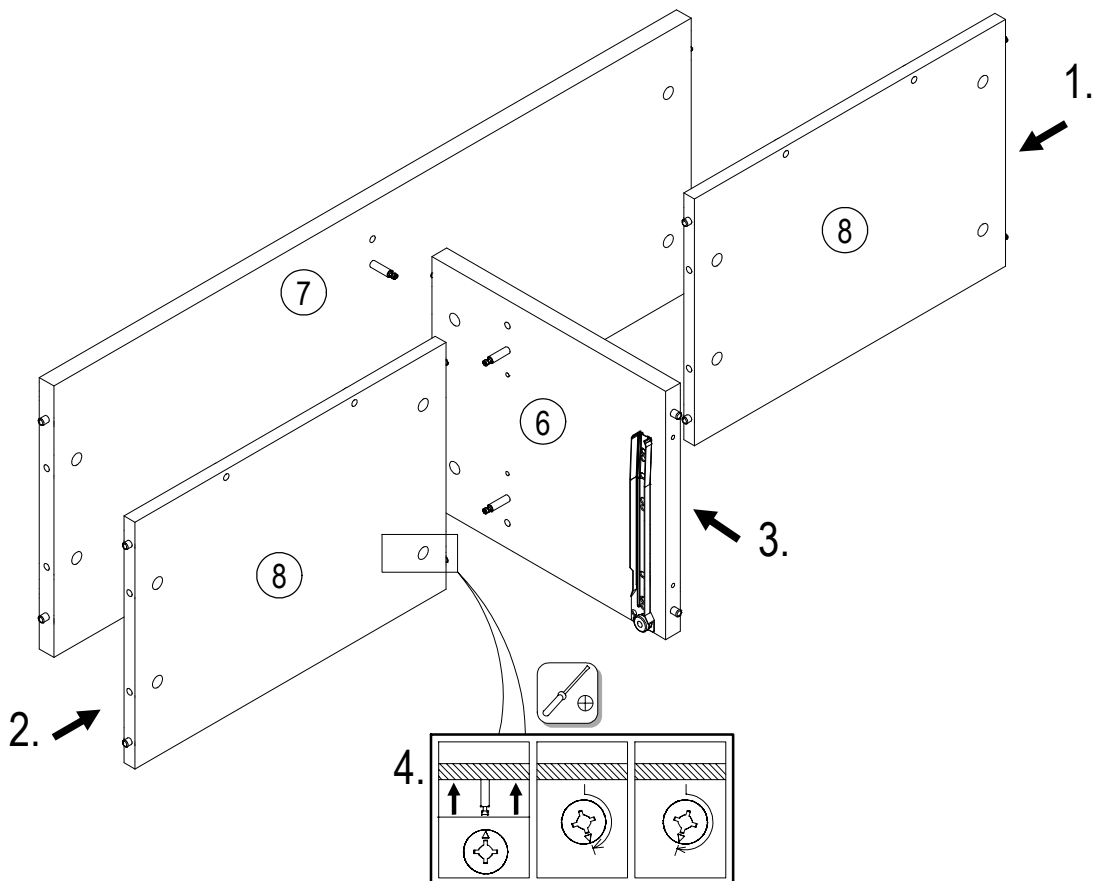
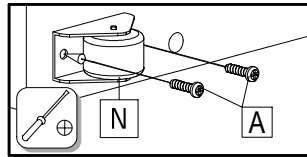
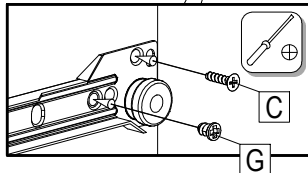
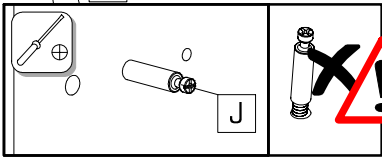
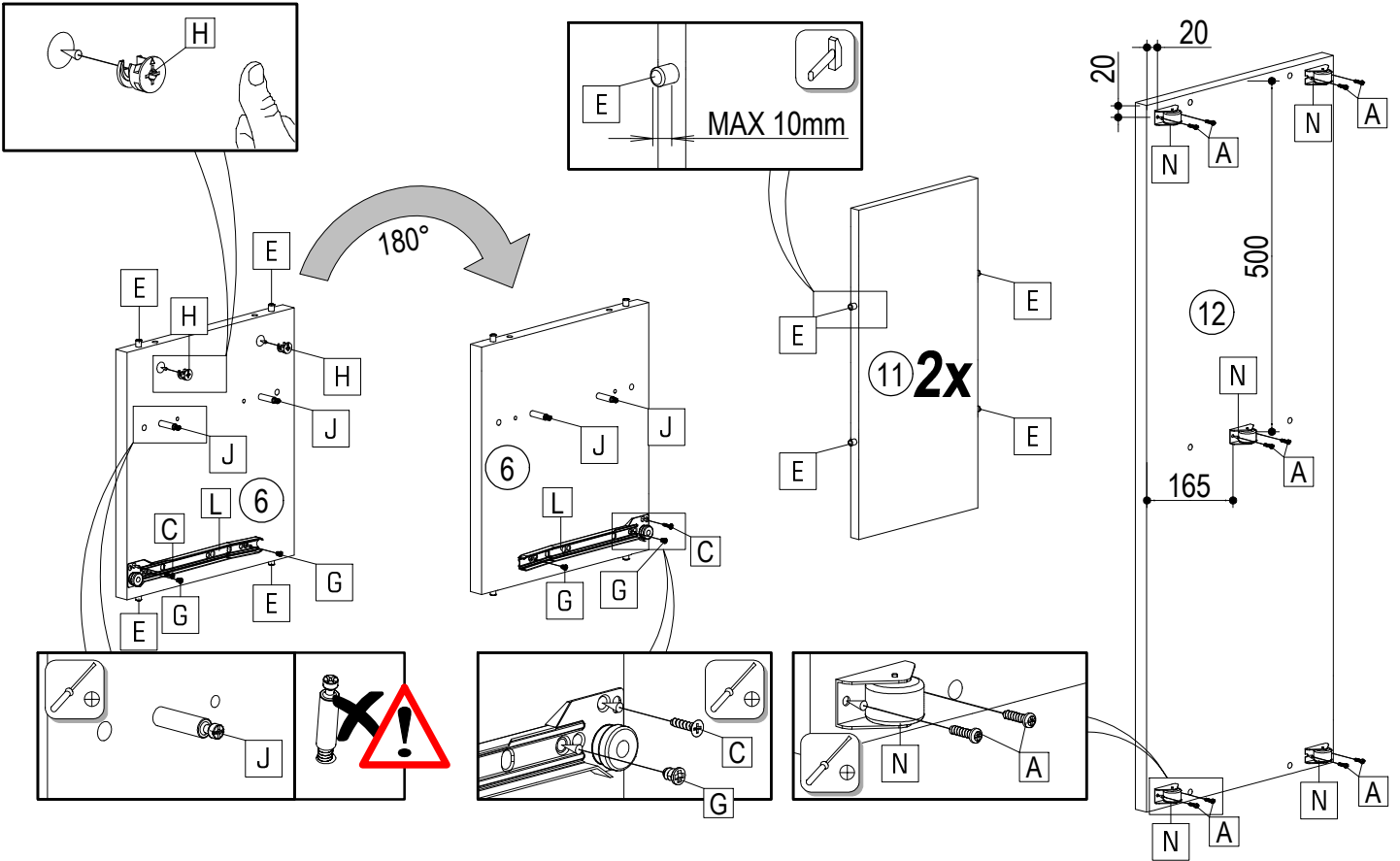

													
C	2x	E	20x	F	4x	G	4x	H	20x	J	18x	L	2x

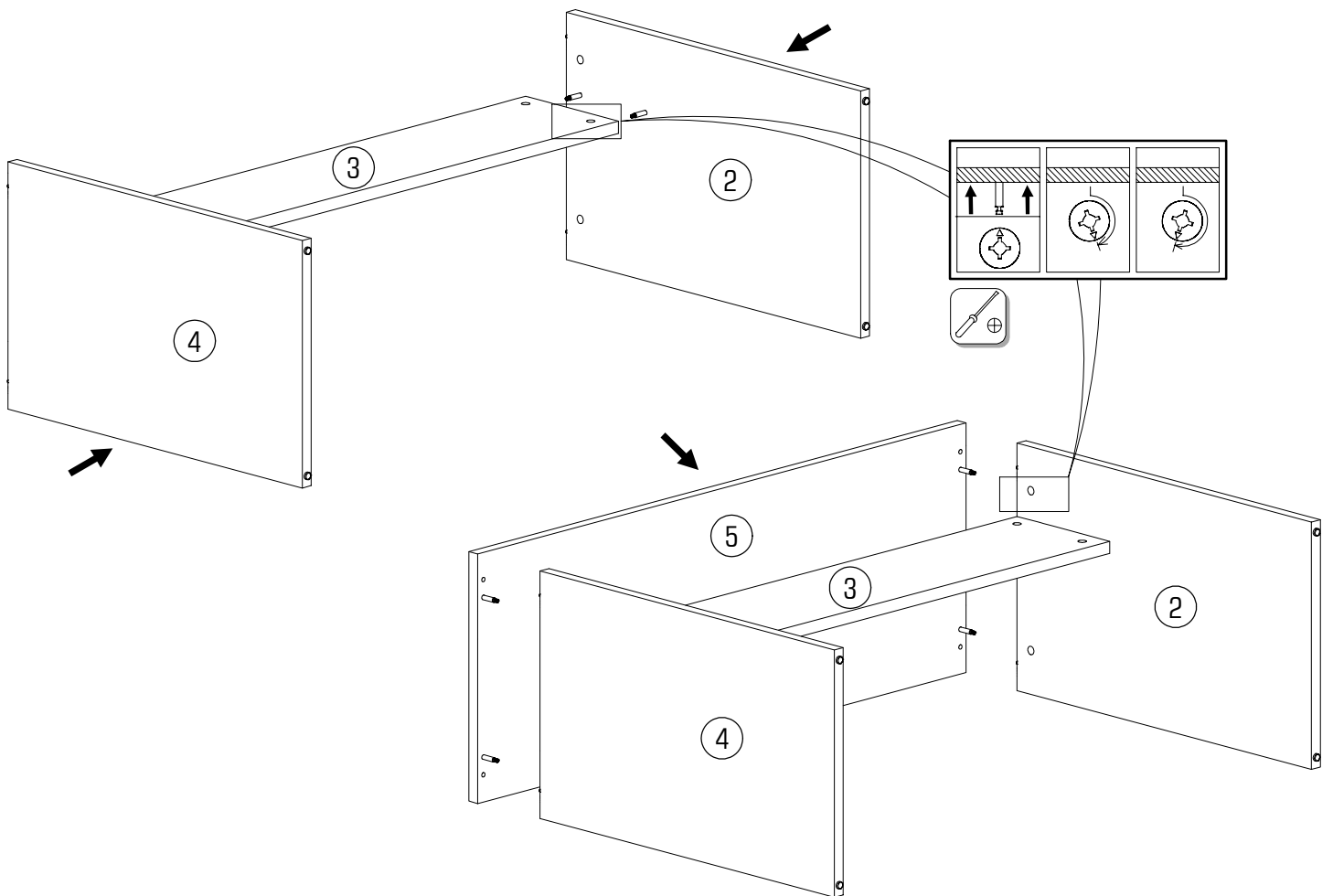
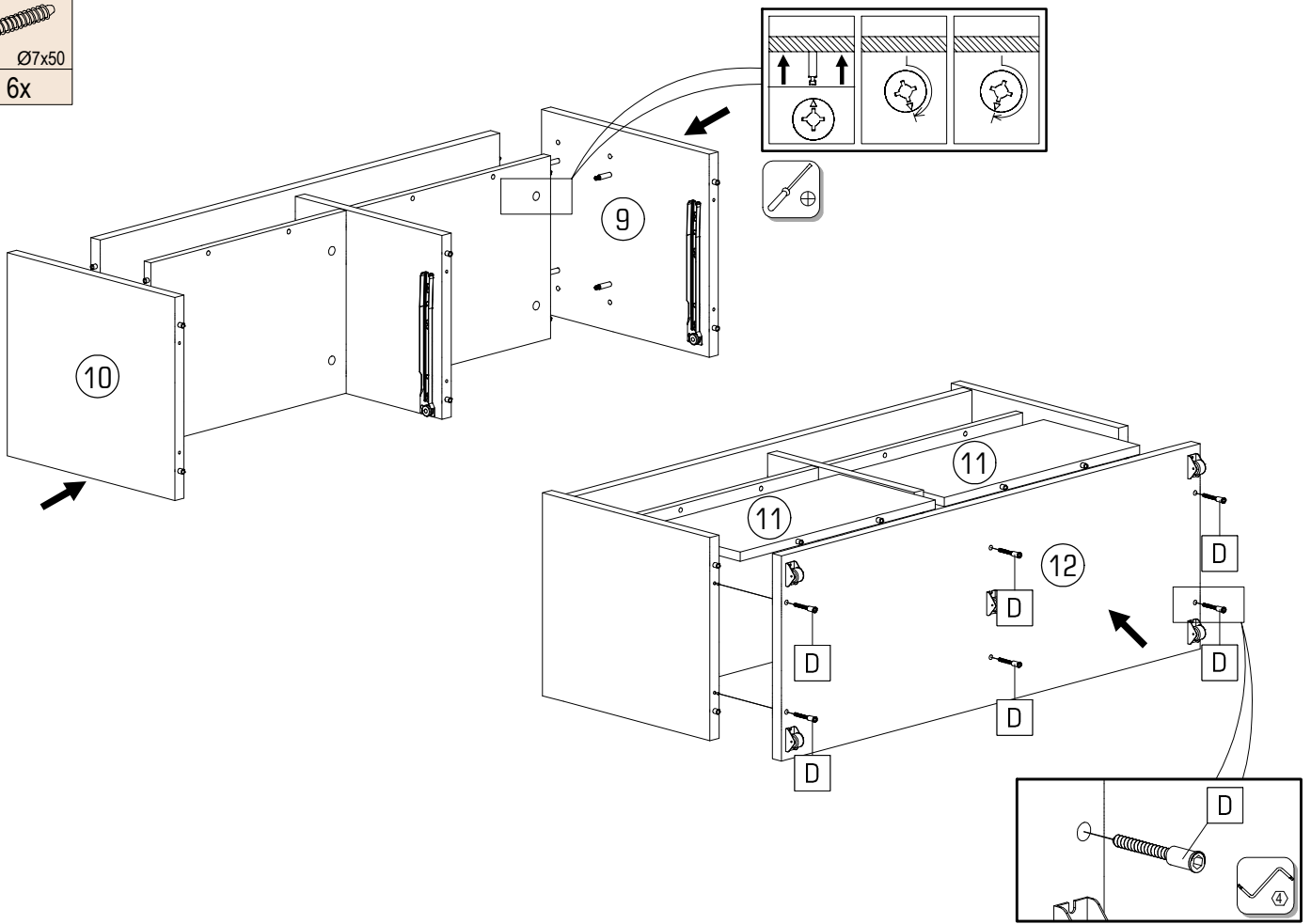
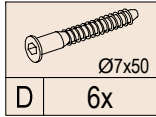

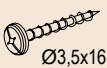
							
A 10x	C 2x	E 12x	G 4x	H 2x	J 4x	L 2x	N 5x

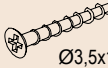
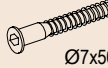

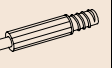

						
A	B	C	D	H	J	L
8x	4x	8x	8x	8x	8x	2x

