

















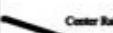







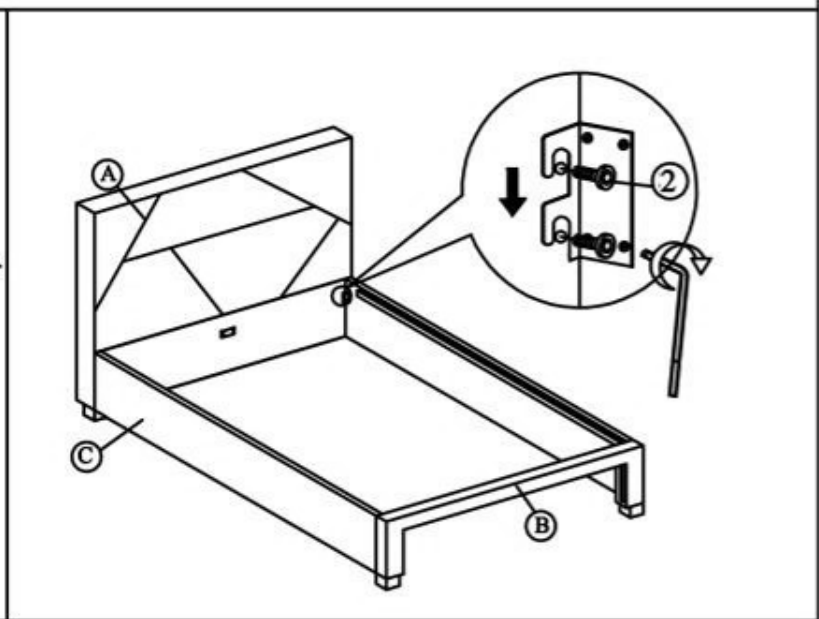
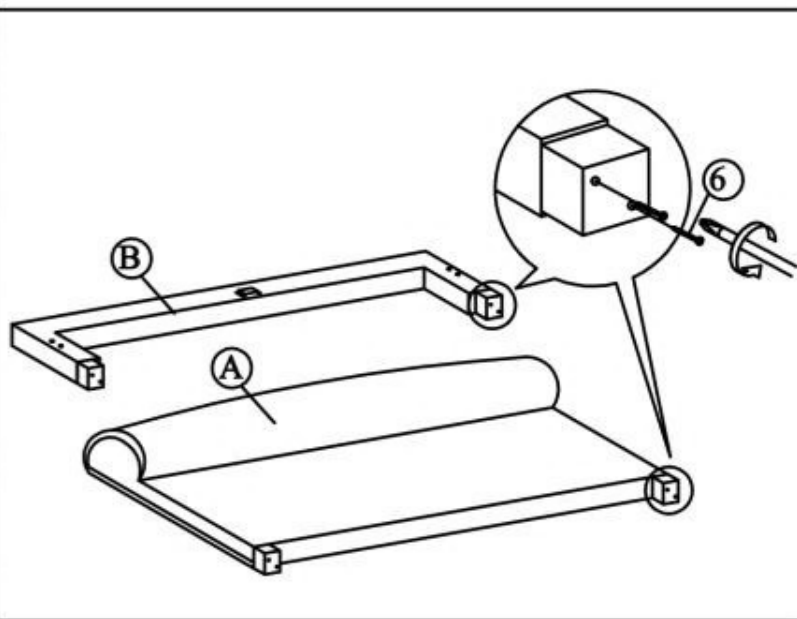

VALERY 160

A		1 pc	I		28 pcs
B		1 pc	J		1 pc
C		2 pcs	K		1 pc
D		4 pcs	L		1 pc
E		1 pc	L.1		1 pc
F		2 pcs	M		1 pc
G		28 pcs	N		3 pcs
H		14 pcs	O		2 pc



hardware

1		2 pcs	9		6 pcs
P	JCBC M6 X 40		X	Roller	
2		8 pcs	10		24 pcs
Q	JCBB M8 X 20		Y	Power Nail 6/8	
3		16 pcs			
R	CSK M4 x 32mm				
4		4 pcs			
S	CSK M4 x 16mm				
5		2 pcs			
T	CSK M4 x 25mm				
6		8 pcs			
U	CSK M4 x 50mm				
7		2 pcs			
V	Adjuster				
8		2 pcs			
W	Metal				

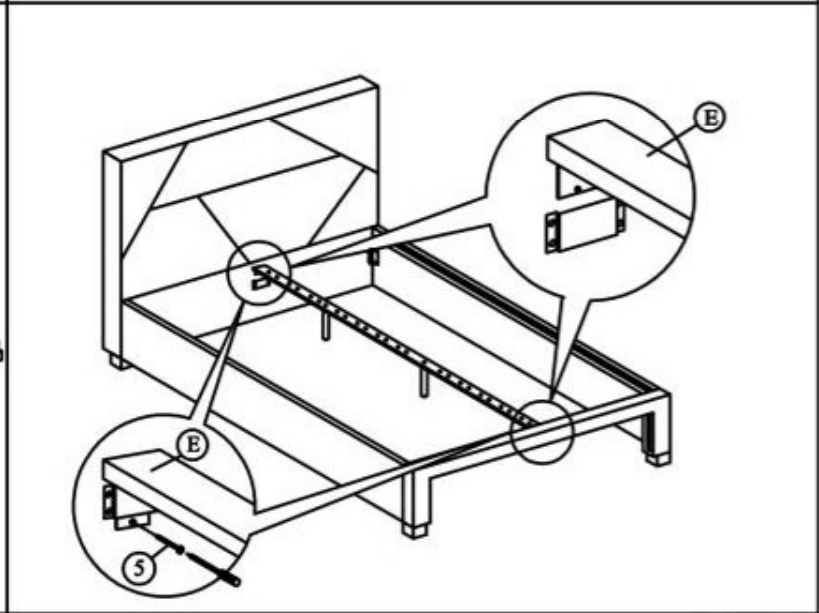
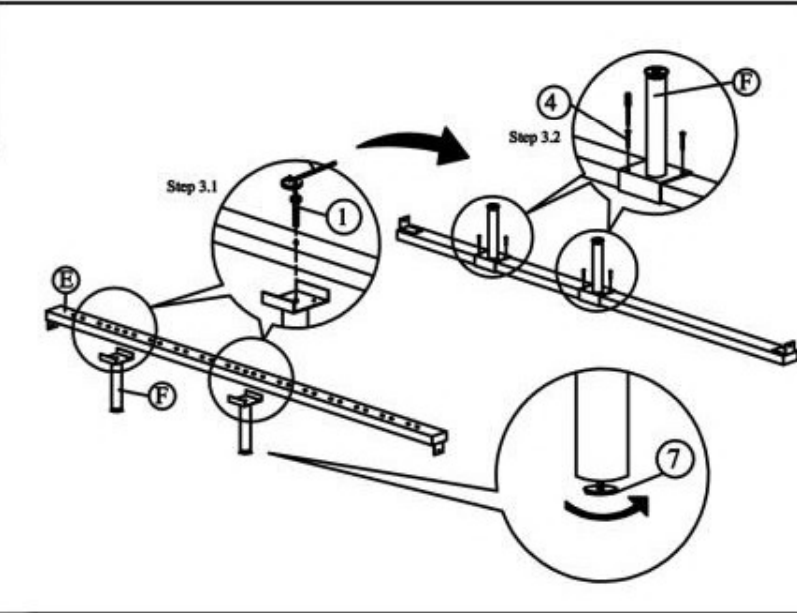

HALMAR Sp. z o.o.

ul. Centralnego Okręgu Przemysłowego 2, 37-450 Stalowa Wola, POLSKA / POLAND
tel. +48 15 843 28 10, fax: +48 15 842 19 57, e-mail: office@halmar.com.pl

1/2

NOWOŚĆ

VALERY 160

