

PRZED ROZPOCZĘCIEM MONTAŻU ZAPOZNAĆ SIĘ Z INSTRUKCJĄ

Narzędzia niezbędne do montażu (nie dostarczane przez producenta)

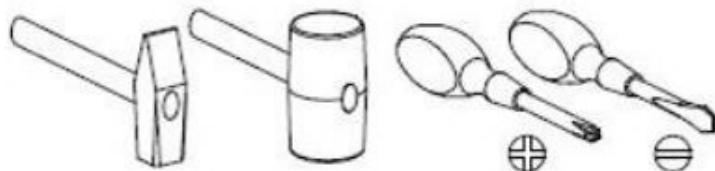
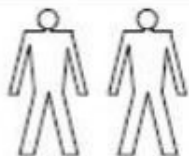

VIGO

Spód

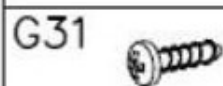
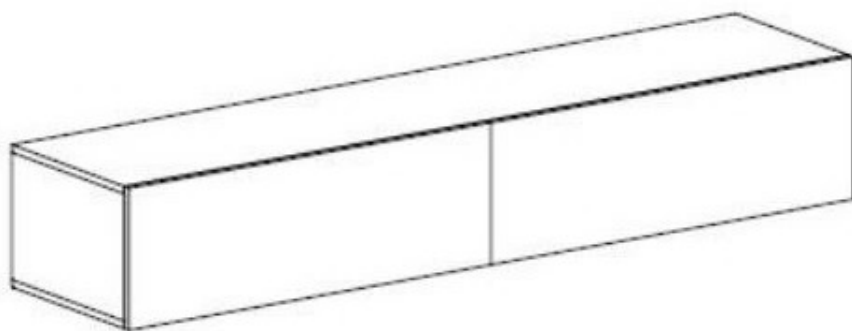
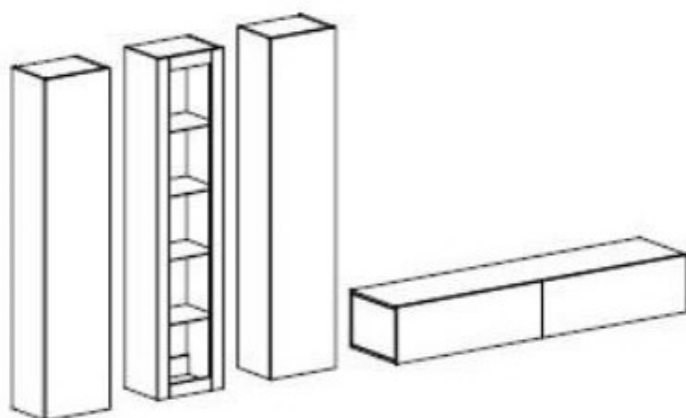

3 x 12 x4

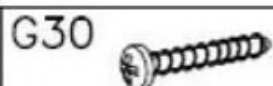

3 x 20 x4



x4

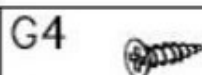

4 x 16 x10

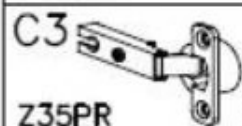

Z35PR x4

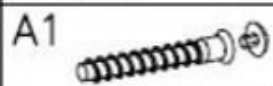

ø7 x 50 x11

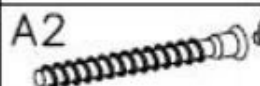

ø7 x 70 x4



PZ35PR x4



x12

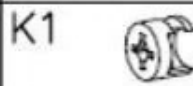

ø15 x 12 x12



x18



x1

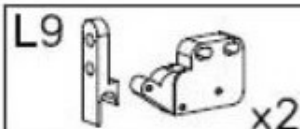

x2

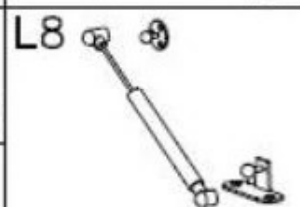

x2

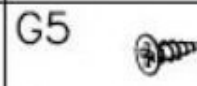

4 x 13 x8

